

brother®

TZ
TAPE

P-touch

1750

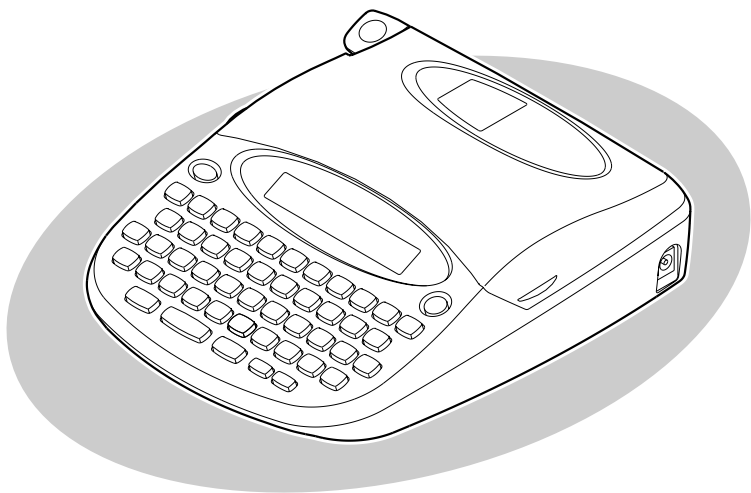

User's Guide

- Read this User's Guide before you start using your P-touch.
- Keep this User's Guide in a handy place for future reference.

INTRODUCTION

Thank you for purchasing the P-touch 1750!

Your new P-touch will allow you to create labels for any need. Its versatility enables you to design custom labels by choosing from a variety of frame designs and from many characters sizes and styles. In addition, the four tape widths (1/4" (6 mm), 3/8" (9 mm), 1/2" (12 mm), and 3/4" (18 mm)) and variety of tape colors allow you to print personalized labels, useful for color-coded filing.

You no longer have to worry about urgent tasks that require professional printing. In the office, the factory, the lab and the home, the quality and performance of the P-touch 1750 makes it an extremely versatile and practical machine.

Finally, as you may want to refer to this User's Guide occasionally, we suggest you keep this manual in a convenient place, as you may wish to refer to it occasionally.

FCC NOTICE

This equipment has been tested and found to comply with the limits for a Class B digital device, pursuant to Part 15 of the FCC Rules. These limits are designed to provide reasonable protection against harmful interference in a residential installation. This equipment generates, uses, and can radiate radio frequency energy and, if not installed and used in accordance with the instructions, may cause harmful interference to radio communications. However, there is no guarantee that interference will not occur in a particular installation. If this equipment does cause harmful interference to radio or television reception, which can be determined by turning the equipment off and on, the user is encouraged to try to correct the interference by one or more of the following measures:

- Reorient or relocate the receiving antenna
- Increase the separation between the equipment and receiver.
- Connect the equipment into an outlet on a circuit different from that to which the receiver is connected.
- Consult the dealer or an experienced radio/television technician for help.
- Changes or modifications not expressly approved by Brother Industries, Ltd. could void the user's authority to operate the equipment.

Patent numbers and patent publication numbers which are related to this product are as below:

USP4839742	USP4983058	USP5120147
USP4927278	USP5009530	
USP4976558	USP5069557	

CONTENTS

Getting Started

GENERAL DESCRIPTION	2
GENERAL PRECAUTIONS	3
BATTERIES	4
OPTIONAL AC ADAPTER	5
TAPE CASSETTE	5
ATTACHING LABELS	6
PRINT HEAD & ROLLERS	8

For Your Information

POWER KEY	9
CURSOR KEYS	9
CODE & SHIFT KEYS	10
SPACE KEY	11
RETURN KEY	12
BS KEY	13
CLEAR FUNCTION	13
ACCENT FUNCTION	14
SYMBOL FUNCTION	15
SIZE FUNCTION	17
STYLE FUNCTION	18
UNDERLINE FUNCTION	19
FRAME FUNCTION	20
BIG SIZE FUNCTION	21
TAPE MARGIN FUNCTION	23
MIRROR PRINTING FUNCTION	24
PRINT KEY & FEED FUNCTION	25
NUMBERING FUNCTION	25
REPEAT PRINTING FUNCTION	27
MEMORY FUNCTIONS	28
TROUBLESHOOTING	31
ERROR MESSAGE LIST	32
SPECIFICATIONS	34
ACCESSORIES	35

Getting Started

GENERAL DESCRIPTION

TOP VIEW

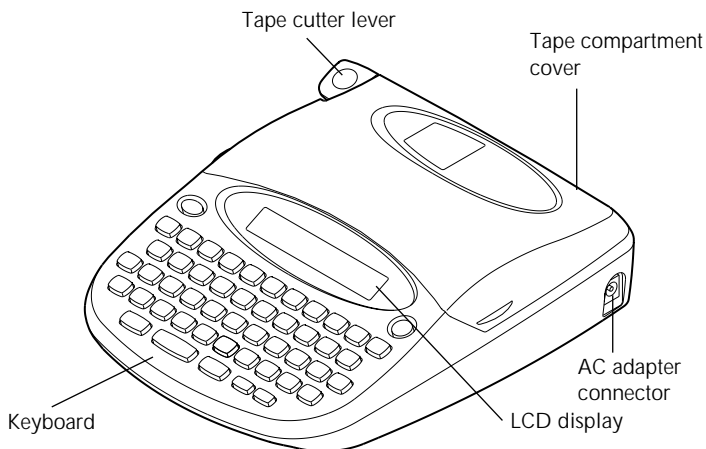

BOTTOM VIEW

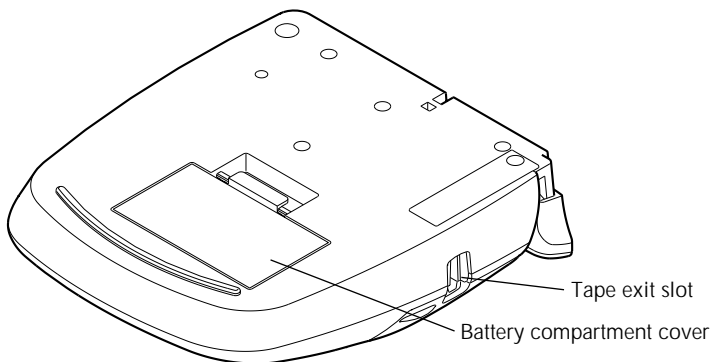

KEYBOARD & LCD DISPLAY

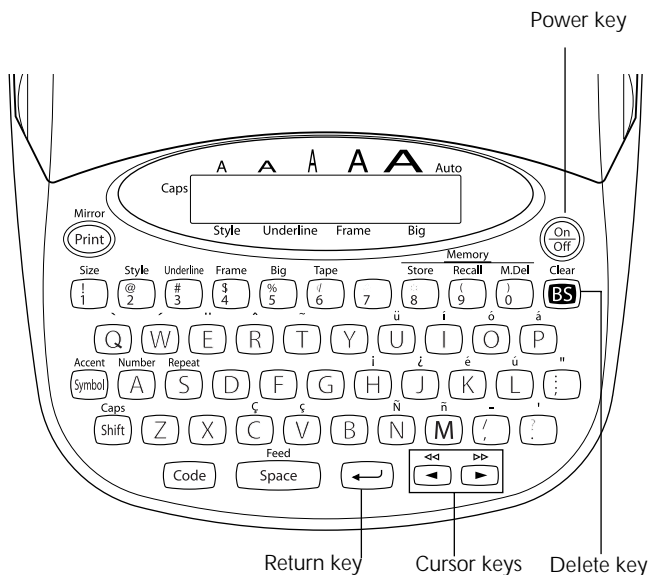

GENERAL PRECAUTIONS

- Use only Brother TZ tapes with this machine. Do not use tapes that do not have the **TZ** mark.
- Do not pull on the tape being fed from the P-touch. This may damage the tape cassette.
- Do not use the machine in dusty places, and keep it out of both direct sunlight and rain.
- Do not expose the machine to high temperatures or high humidity. Never leave it on the dashboard or in the back of your car.
- Do not leave any rubber or vinyl on the machine for an extended period of time. Doing so may cause staining.
- Do not clean the machine with alcohol or other organic solvents. Use a soft, dry cloth only.
- Do not put any foreign objects into or anything on the machine.
- To avoid injuries, do not touch the cutter's edge.
- Use only the AC adapter (model AD-30) designed exclusively for this machine. Use of any other adapter will void the warranty.

- Do not try to disassemble the AC adapter.
- When the machine is not being used for a long period of time and it is not necessary to keep the text files stored in the memory, disconnect the AC adapter, and remove the batteries to prevent them from leaking and damaging the machine.
- When the AC adapter is connected, unplugging the adapter from the electrical outlet before unplugging it from the machine can delete all text files in the memory, even if batteries are installed.
- **Use six AA batteries in this machine.**
- To prevent damage during shipment, a clear protective sheet is placed over the LCD panel. Remove this clear protective sheet before beginning use.

BATTERIES

This lightweight and portable machine can be used anywhere by installing six (6) **AA batteries**. When you change the batteries, always replace all six at the same time.

To change the batteries:

- 1 Remove the battery compartment cover on the back of the machine.
- 2 If batteries are already installed, remove them.
- 3 Insert six new AA batteries, making sure that they face the correct direction.
- 4 Attach the battery compartment cover.

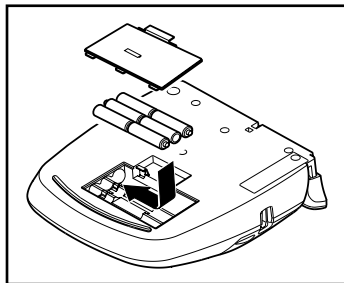

Be sure to insert the new batteries within five minutes of removing the old ones, otherwise the text shown in the display and any text files stored in the memory will be lost (unless the machine is plugged into an AC outlet with the AC adapter).

OPTIONAL AC ADAPTER

The AC adapter (model AD-30) allows you to use this machine wherever there is an electrical outlet.

To connect the optional AC adapter:

- 1 Insert the plug on the adapter cord into the connector marked DC IN 7.0V on the right side of the machine.
- 2 Insert the plug on the adapter into the nearest standard electrical outlet.

 *Only use the AC adapter designed exclusively for this machine. Remove the batteries and disconnect the AC adapter if you do not intend to use this machine for an extended period of time. When the power is disconnected, all text shown in the display and stored in the memory will be lost.*

It is recommended that you use the AC adapter when printing large fonts on 3/4" (18-mm)-wide tape since this operation can quickly drain the batteries.

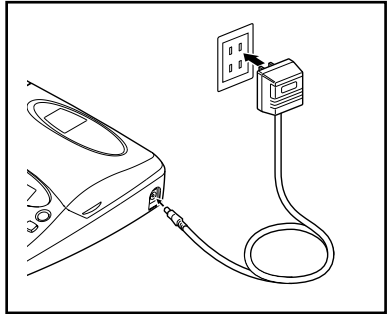

TAPE CASSETTE

A single TZ tape cassette is supplied with this unit. However, since TZ tape cassettes are available for this machine in a wide variety of colors and sizes, it is possible to make distinctive color-coded and stylized labels.

In addition, this machine has been designed to allow you to change the tape cassettes quickly and easily.

To change the tape cassette:

- 1 Lift open the tape compartment cover. The installed cassette is also released.
- 2 If a tape cassette is already installed, remove it by pulling it straight up.
- 3 If the ink ribbon in the other tape cassette is loose, use your finger to wind the toothed wheel in the direction of the arrow on the cassette until there is no slack in the ribbon. Also, make sure that the end of the tape feeds under the tape guides.

 *If you are using a new tape cassette provided with a stopper, be sure to remove the stopper.*

- 4 Insert the tape cassette firmly into the tape compartment, making sure that the entire back of the cassette touches the bottom of the compartment.

 *When inserting the tape cassette, make sure that the inner ribbon does not catch on the corner of the metal guide.*

- 5 Close the compartment cover, then turn on the machine if it is off.
- 6 Hold down **Code** and press **Feed Space** once to advance the tape and remove any slack.
- 7 Push down on the tape cutter lever to cut off any excess tape.

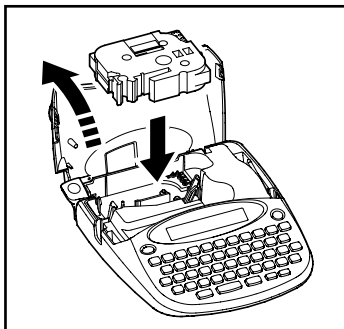

ATTACHING LABELS

STICK

A stick is enclosed in the right side of the tape compartment cover of the P-touch. Use this stick when pasting laminated tape to an object.

- 1 Open the tape compartment cover.
- 2 Pull the tip of the stick towards you with your finger.
- 3 Hold the tip of the stick and pull up to remove it.

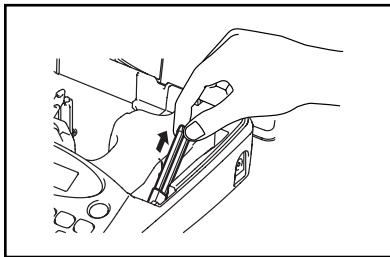
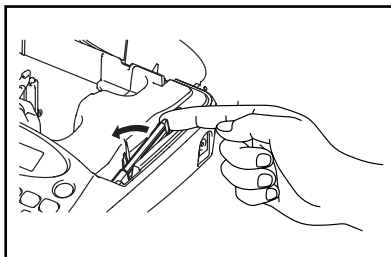

LAMINATED TAPE

The enclosed stick enables you to easily remove the backing from labels printed on laminated tapes.

- 1 Hold the tape in your left hand, with the printed surface facing up, and hold the stick in your right hand.
- 2 Pass the tape halfway through the long narrow hole in the stick.
- 3 Turn the stick three-quarters of a turn towards you and pull the stick away from you as shown below.
- 4 Peel off the label backing.

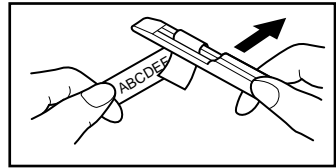
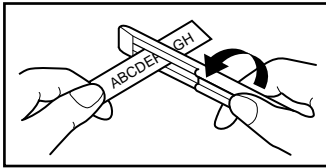

FABRIC TAPE

Fabric tape is used to attach a piece of fabric printed with your text onto garments using an iron. After printing the text onto fabric tape and cutting off the label using scissors, place the label on an ironed garment at the location where you wish to attach it in such a way that the printed text can be read correctly. Cover the label with another piece of cloth and use an iron set to a medium-high temperature (320 to 356 °F (160 to 180 °C)) to press down firmly for 10 to 15 seconds. For more details, refer to the instructions included with the fabric tape cassette.

PRINT HEAD & ROLLERS

Occasionally, specks of dust or dirt become attached to the machine's print head and rollers. This is particularly likely when you are using the unit outdoors or in a very dusty environment. If a section of the print head is covered with dust, a blank horizontal streak may appear through the label text. Therefore, as with a tape recorder, the machine's head may need to be cleaned from time to time.

To clean the print head and rollers:

- 1 Turn off the machine.
- 2 Open the tape compartment cover, then remove the tape cassette if one is installed. The print head and rollers are located in the tape compartment.
- 3 Print head: Use a dry cotton swab to gently wipe the print head with an up-and-down motion.
Rollers: Use a dry cotton swab to wipe each roller with an up-and-down motion while rotating them with your finger.
- 4 Install a tape cassette, close the tape compartment cover, and then try printing again.
- 5 If dust still remains, repeat steps 3 and 4 using a cotton swab dipped in isopropyl (rubbing) alcohol.

If none of the above works, contact your service representative.

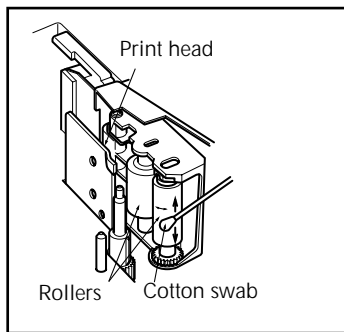
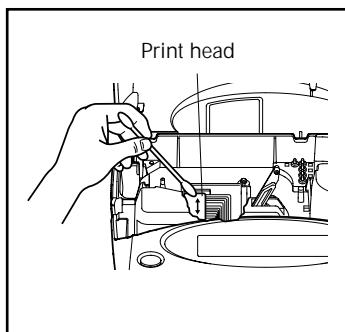

 Cleaning can also be done by using the optional print head cleaning cassette (TZ-CL4).

For Your Information

POWER KEY

The power key () is located in the top right-hand corner of the keyboard. If batteries have been installed or the machine has been plugged in using the optional AC adapter, the previous session's information is displayed when the machine is turned on. This feature allows you to stop work on a label, turn off the machine, and return to it later without having to re-enter the text.

 *If you press any key during the opening message, you can skip the message.*

The machine will automatically turn off if no key is pressed within 5 minutes. The machine's internal memory stores the current session's information and displays it when you turn on the machine again.

To turn on the machine:

- Press . The previous session's information appears in the LCD display.

To turn off the machine:

- Press . The current session's information is stored in the internal memory.

CURSOR KEYS

The machine's LCD display shows one row of 15 characters; however, the text that you create can be up to 60 characters long. You can review and edit your text by using the cursor keys to move the cursor so that different parts are shown in the display.

LEFT CURSOR KEY



To move the cursor one character to the left:

- Press  once.

To move the cursor several characters to the left:

- Hold down  until the cursor moves to the desired position.

To move the cursor to the beginning of the text line:

- Hold down  and press .

RIGHT CURSOR KEY



To move the cursor one character to the right:

- Press  once.

To move the cursor several characters to the right:

- Hold down  until the cursor moves to the desired position.

To move the cursor to the end of the text line:

- Hold down  and press .

CODE & SHIFT KEYS

Most characters can be entered simply by pressing their keys. However, to use special functions or to enter capital letters, accented characters and some symbols, the following special keys are necessary.

CODE KEY



To use a function printed above a key:

- Hold down  and press the key immediately below the desired function.

EXAMPLE

To start the Feed function:



- Hold down  and press  once.

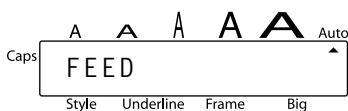

SHIFT KEY

To type in a capital letter or a symbol printed in the top left-hand corner of a key:

- Hold down  and press the key of the desired letter or symbol.

EXAMPLE

To type in "%":



- Hold down **Caps Shift** and press **Big**.

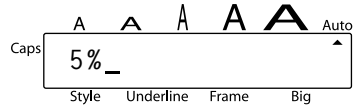

The **Caps** mode is similar to holding down **Caps Shift**. It allows you to type capital letters continuously.

To type in many capital letters:

- 1 Hold down **Code** and press **Caps Shift**. The **Caps** indicator on the left side of the display lights up.



- 2 Press the keys of the desired letters or symbols.
- 3 To exit **Caps** mode, hold down **Code** and press **Caps Shift**. The **Caps** indicator goes off.

SPACE KEY

The **Space** key (**Feed Space**) lets you add blank spaces between characters in your text. It is different from the right cursor key (**Right Arrow**), which just moves the cursor without adding blank spaces.

To add a space:

- Press **Feed Space**.

EXAMPLE

To add a space:

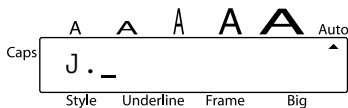



- Press .



RETURN KEY

Like on a typewriter or word processor, this machine's return key () is used to end a line of text and start another one. When you have finished entering one line, press the return key to make a new line and move the cursor to it.

 A label can only contain a maximum of two text lines. If you press  when the cursor is located in the second line, the error message "2 LINE LIMIT!" will appear.



Maximum number of lines that can be printed	Tape widths
1	1/4" (6 mm)
2	3/8" (9 mm), 1/2" (12 mm), 3/4" (18 mm)

The return key can also be used to select an item from a list (e.g., add a symbol or accented character to the text) or to apply a selected setting.

Some questions asking you to confirm a command may appear on the LCD display, especially when the function that you have chosen will delete or affect files. In these cases, pressing  is like answering "yes".

 To answer "no", press . Refer to "BS KEY" on page 13.

To add a new line:

- Press . The return mark () appears to indicate the end of the line.



To select an item from a list:

- Press .

To answer "yes":



- Press .

BS KEY



The delete key () allows you to remove characters to the left of the cursor's current position. It differs from the left cursor key () , which only moves the cursor without deleting any characters.

The delete key can also be used to quit most functions and return to the previous display without changing the text.

Some questions asking you to confirm a command may appear on the LCD display, especially when the function that you have chosen will delete or affect files. In these cases, pressing  is like answering "no".

 To answer "yes", press . Refer to "RETURN KEY" on page 12.

To delete one character:

- 1 Press  or  to position the cursor below the character immediately to the right of the character that you wish to delete.
- 2 Press  once.

To quit a function without changing your text:

- Press  to return to your text.

To answer "no":



- Press .

CLEAR FUNCTION

When clearing the display before entering new text, the **Clear** function can be used to choose whether all of the text is erased.

 The **Clear** function only deletes the text. The format functions (**Size**, **Style**, **Underline**, **Frame**, **Big size**, **Tape margin**, and **Mirror printing**) do not return to the default settings, but stay as they are.

To delete all of the text:

- 1 Hold down  and press .
- 2 All of the text will be deleted.

EXAMPLE

To clear the text:

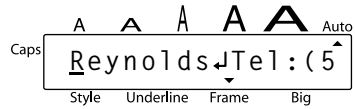

1 Hold down **Code** and press **Clear BS**.

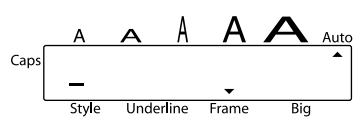

ACCENT FUNCTION

The **Accent** function can also be used to add accented characters to your text.

The accented characters are grouped according to the capital or small letter that they are combined with. The following accented characters are available:

Letters	Accented characters	Letters	Accented characters
a	à á â ã ä æ	l	í î ï
A	À Á Â Ã Ä Å Æ	n	ñ
c	ç	N	Ñ
C	Ç	o	ó ô õ ö
e	è é ê ë ì	O	Ó Ô Õ Ö
E	È É Ê Ë Ì	u	ù ú û ü
i	í î ï	U	Û Ü Û Ü

To type in an accented character:

- 1 Hold down **Code** and press **Symbol**^{Accent}. The message "A – U?" appears on the display.
- 2 Press the key of the letter in the desired accented character.
*To type a capital letter, hold down **Shift**^{Caps} (or hold down **Code** and press **Shift**^{Caps} to turn on **Caps** mode) before pressing the letter key.*
- 3 Press **←**^{del} or **→**^{ins} until the cursor is under desired accented character.
- 4 Press **↵**. The accented letter is added to the text.

EXAMPLE

To add the accented character "É":

- 1 Hold down **Code** and press **Symbol**^{Accent}.

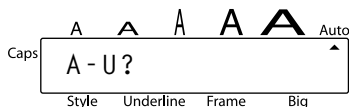

- 2 Hold down **Shift**^{Caps} and press **E**[¨].



- 3 Press **→**^{ins} until the cursor is under É.



- 4 Press **↵**.

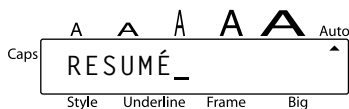





SYMBOL FUNCTION

In addition to the letters, symbols and numerals on the key tops, there are 48 additional marks available with the **Symbol** function.

The following symbols are available:

Group	Symbol
1	Æ æ • ° + × ÷ = _ ^ [] ™ ® ©
2	§ ² ³ ² ³ 4 ↑ ↓ → ← ↵ ↶ ♪ ♥ ★
3	☎ 📁 📧 ☠ ☹ 🍷 🔥 ♿ ⚠ 🏠 🌐 🌐 🔑 🌐 🍷
4	👁 🧐 🍷

To type in a symbol:

- 1 Press . The message "1-4?" appears on the display.
- 2 Press a key 1 to 4 to choose the set that contains the desired symbol.
- 3 Press  or  until the cursor is under the desired symbol.
- 4 Press . The symbol appears in the text.

EXAMPLE

To add the symbol "☠":

- 1 Press .

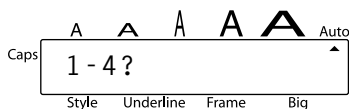

- 2 Press .

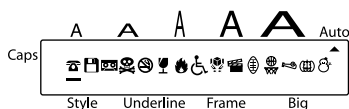

- 3 Press  until the cursor is under ☠.

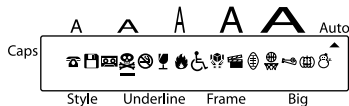

- 4 Press .



SIZE FUNCTION

The character size can be adjusted using the **Size** function. The following table shows the character sizes.







Size	Character
SIZE 1	Standard Size
SIZE 2	Double Width
SIZE 3	Double Height
SIZE 4	Double Width & Double Height
SIZE 5	4 × Width & Double Height
AUTO	1/4" (6 mm) tape: SIZE 1 3/8" to 3/4" (9 mm to 18 mm) tape: SIZE 4

The default size setting is **AUTO**. The currently selected size setting is always shown by the indicator above the display.

	SIZE 1	SIZE 2	SIZE 3	SIZE 4	SIZE 5
Sample	A	A	A	A	A

When 6 mm tape is installed and SIZE 3, 4 and 5 is set for horizontal printing or SIZE 2, 4 and 5 is set for vertical printing, the "CHR_SIZE:AUTO?" message will display. Press  to print in the **AUTO** size.

To change the size setting:

- While holding down , press  once, and keep  held down to display the current size setting.
- While still holding down , continue pressing  until the desired size setting is displayed and is shown by the size indicator.
 *The current character size setting is also shown by the size indicator above the display.*
- Release  to apply the selected size setting to the entire text.

EXAMPLE

To select **SIZE3**:

- 1 While holding down **Code**, press **Size** once, and keep **Code** held down.

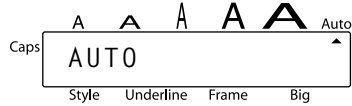

- 2 While still holding down **Code**, continue pressing **Size** until **SIZE3** is displayed.

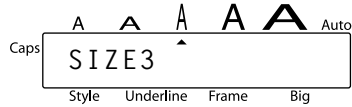

- 3 Release **Code**.

STYLE FUNCTION

You can choose from nine different character styles to apply to your text.

 Characters printed using the smaller sizes may be difficult to read if certain style settings (e.g., *ITALIC+SHADOW*) are selected.

The following style settings are available:

NORMAL, OUTLINE, BOLD, SHADOW, ITALIC,
ITALIC+OUTLINE, ITALIC+BOLD, ITALIC+SHADOW, VERTICAL

The default style setting is **NORMAL**. The style indicator at the bottom left of the display shows the current style setting when any setting other than **NORMAL** is selected.

Refer to *Reference* at the end of this section for samples of the available settings.

To change the style setting:

- 1 While holding down **Code**, press **Style** once, and keep **Code** held down to display the current style setting.
- 2 While still holding down **Code**, continue pressing **Style** until the desired style setting is displayed.
- 3 Release **Code** to apply the selected style setting to the entire text.

EXAMPLE

To select the **ITALIC+SHADOW** style setting:

- 1 While holding down **Code**, press **Style** $\left(\frac{\text{Style}}{2}\right)$ once, and keep **Code** held down.



- 2 While still holding down **Code**, continue pressing **Style** $\left(\frac{\text{Style}}{2}\right)$ until **ITALIC+SHADOW** is displayed.



REFERENCE

Style	Sample	Style	Sample
NORMAL	abc	ITALIC + OUTLINE	<i>abc</i>
OUTLINE	abc	ITALIC + BOLD	<i>abc</i>
BOLD	abc	ITALIC + SHADOW	<i>abc</i>
SHADOW	abc	VERTICAL	α Ω Ο
ITALIC	<i>abc</i>		

UNDERLINE FUNCTION

You can emphasize your text by underlining it.

The default underline setting is **OFF**. In this case, "TEXT" will show on the display. When the **Underline** function is set to **UNDERLINE**, the **Underline** indicator on the bottom of the display lights up.

 The underline and frame settings can not be made at the same time.

ABC

To turn on or off the Underline function:

- 1 While holding down **Code**, press **# 3** ^{Underline} once, and keep **Code** held down to display the current underline setting.
- 2 While still holding down **Code**, continue pressing **# 3** ^{Underline} until the desired underline setting is displayed.
 The **Underline** indicator lights up when the **UNDERLINE** setting is selected.
- 3 Release **Code** to apply the selected underline setting to the entire text.

EXAMPLE

To select the UNDERLINE setting:

- 1 While holding down **Code**, press **# 3** ^{Underline} once, and keep **Code** held down.
- 2 While still holding down **Code**, continue pressing **# 3** ^{Underline} until **UNDERLINE** is displayed.
- 3 Release **Code**.



FRAME FUNCTION

With the **Frame** function, you can choose from various frames and highlights to design a more decorative or emphasized label.

The following Frame settings are available:

TEXT, ROUND, WOODEN, POINTING, CANDY

The default frame setting is **TEXT**; however, other settings are also available. When any setting other than **TEXT** is selected, the **Frame** indicator on the bottom of the display lights up.

 The underline and frame settings can not be made at the same time.

Refer to *Reference* at the end of this section for samples of the available settings.

To change the frame setting:

- 1 While holding down **Code**, press **# 4** ^{Frame} once, and keep **Code** held down to display the current frame setting.

- While still holding down **Code**, continue pressing **Frame** until the desired frame setting is displayed.
 The **Frame** indicator lights up when any setting other than **TEXT** is selected.
- Release **Code** to apply the selected frame setting to the entire text.

EXAMPLE

To select the **CANDY** frame setting:

- While holding down **Code**, press **Frame** once, and keep **Code** held down.
- While still holding down **Code**, continue pressing **Frame** until **CANDY** is displayed.
- Release **Code**.

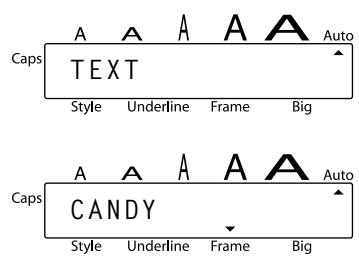

REFERENCE

Frame setting	Frame sample	Frame setting	Frame sample
TEXT	ABC	POINT-ING	
ROUND		CANDY	
WOODEN			

BIG SIZE FUNCTION

The **Big Size** function can be used when 3/4" (18 mm) tape is inserted and one row of text is entered. When printing with the **Big Size** function turned on, letters entered in lowercase will be printed as uppercase letters.







OFF	ON
ABC	ABC

The default setting is **OFF**. When you turn the **Big Size** function **ON**, the Big indicator will light up in the bottom right of the display.

☞ If you change any of the **Size**, **Style**, **Underline**, or **Frame** settings after making the **Big Size** setting, the **Big Size** font will automatically return to the default value and **Size**, **Style**, **Underline**, or **Frame** settings will take precedence.







If the **Big Size** setting is made when tape other than 3/4" (18 mm) is inserted, the message "CHR_SIZE:AUTO?" will display. Press  to print in the **AUTO** size.

To change the Big Size setting:

- 1 Insert the 3/4" (18 mm) tape cassette and enter one row of text.
- 2 While holding down , press  once, and keep  held down to display the current setting.
- 3 While still holding down , press  to make the **ON** setting.
☞ The **Big** indicator lights up when the **ON** setting is made.
- 4 Release  to apply the selected setting to the entered text.

EXAMPLE

To select the Big Size ON setting:

- 1 While holding down , press  once, and keep  held down.
- 2 While still holding down , continue pressing  until **ON** is displayed.
- 3 Release .

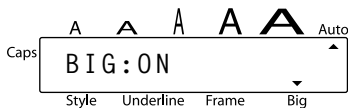
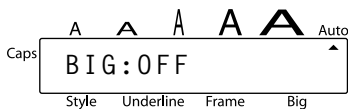

TAPE MARGIN FUNCTION

The **Tape margin** function allows you to adjust the size of the margins on the left and right sides of your text.

The default tape margin setting is **FULL**; however, three other settings are also available.

FULL
(1" (25 mm margins))



NONE
(1/12" (2 mm margins))

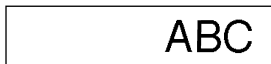

NARROW
(1/6" (4 mm margins))

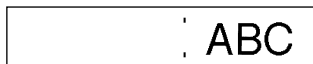

HALF
(1/2" (12 mm margins))

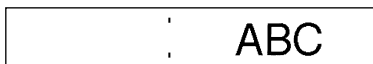

☞ After printing using the **NARROW** and **HALF** tape margin settings, push down on the tape cutter lever to cut off the label, then use scissors to cut along the printed dots (:) to center the text within the label.

To change the tape margin setting:

- 1 While holding down **Code**, press **Tape** $\frac{c}{6}$ once, and keep **Code** held down to display the current tape margin setting.
- 2 While still holding down **Code**, continue pressing **Tape** $\frac{c}{6}$ until the desired tape margin setting is displayed.
- 3 Release **Code** to apply the selected tape margin setting to the entire text.

EXAMPLE

To select the HALF tape margin setting:

- 1 While holding down **Code**, press **Tape** $\frac{c}{6}$ once, and keep **Code** held down.



- 2 While still holding down **Code**, continue pressing **Tape** $\frac{c}{6}$ until **HALF** is displayed.



- 3 Release **Code**.

MIRROR PRINTING FUNCTION

With this function, you can print your text so that the characters can be read from the tape side of the tape. If mirror-printed labels are attached to glass or some other clear material, they can be read correctly from the opposite side.

☞ When using the **Mirror printing** function, the text should be printed on clear tape. The default mirror printing setting is **OFF**.

MIRROR : ON

ABC

To turn on or off the mirror printing setting:

- 1 While holding down **[Code]**, press **[Print]** once, and keep **[Code]** held down to display the current mirror printing setting.
- 2 While still holding down **[Code]**, continue pressing **[Print]** until the desired mirror printing setting is displayed.
- 3 Release **[Code]** to apply the selected mirror printing setting to the entire text.

EXAMPLE

To select the **ON** mirror printing setting:

- 1 While holding down **[Code]**, press **[Print]** once, and keep **[Code]** held down.
- 2 While still holding down **[Code]**, continue pressing **[Print]** until **ON** is displayed.
- 3 Release **[Code]**.





PRINT KEY & FEED FUNCTION

After you have entered your text and chosen the desired format settings, you are ready to print.

To print a label:

- Press  once. The message "PRINTING" is displayed.

To feed the tape:

- Hold down  and press  once. 1" (25 mm) of tape is fed out.

To cut the tape:

- Push down on the tape cutter lever.



 *In order to prevent damaging the tape, do not try to cut it while printing or feeding. Pushing down on the tape cutter lever too far may break it.*

EXAMPLE

To make a label using the NONE tape margin setting:

- 1 Press  once.









- 2 Hold down  and press  once.

- 3 Push down on the tape cutter lever.



NUMBERING FUNCTION

This function can be used to print many copies of the same text while increasing a certain number in the text by 1 after each label is printed.

To use the Numbering function:

- 1 Press  or  to position the cursor below the number that you wish to increase.
- 2 Hold down  and press . The message "NUMBER:1-9?" appears in the display.
- 3 Press the number key ( to ) of the last number that is to be printed.

 *To cancel the **Numbering**, hold down  and press  (or press just ).*

- 4 Press  (or ) to begin printing the labels.

- Press down on the tape cutter lever to cut the tape, and then use scissors to cut along the printed dots to separate the labels.

EXAMPLE

To print three labels with numbers 1, 2 and 3:

- Position the cursor below "1".

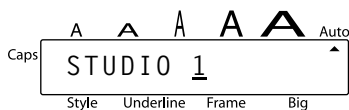

- Hold down **Code** and press **Number** (A).



- Press **Underline** (3).



- Press **Mirror** (Print) (or **←**).



- Press in the tape cutter lever to cut the tape, then use scissors to cut along the cutting guide to separate the labels.



REPEAT PRINTING FUNCTION

This function allows you to print up to 9 copies of the same text.

To use the Repeat printing function:

- 1 Hold down **Code** and press **S**^{Repeat}. The message "REPEAT:1-9?" appears in the display.
- 2 Press the number key (**1** to **9**) of the number of labels that you want.
*To cancel the Repeat printing, hold down **Code** and press **S**^{Repeat} (or press just **BS**^{Clear}).*
- 3 Press **Print**^{Mirror} (or **←**) to begin printing the labels.
- 4 Press down on the tape cutter lever to cut the tape, and then use scissors to cut along the printed dots to separate the labels.

EXAMPLE

To print three copies of a label:

- 1 Hold down **Code** and press **S**^{Repeat}.



- 2 Press **3**^{Underline}.





- 3 Press **Print**^{Mirror} (or **←**).

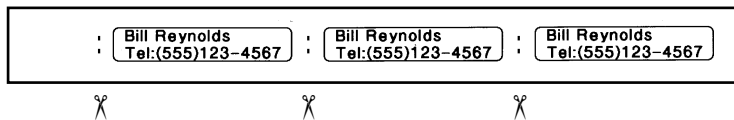

- 4 Press in the tape cutter lever to cut the tape, then use scissors to cut along the cutting guide to separate the labels.



MEMORY FUNCTIONS

You can use the memory to store your most frequently used text files. The text remains in the memory, even after all characters are removed from the display using the **Clear** function (holding down  and pressing ).

When each file is stored, it is given a number to make recalling it easier. Up to 9 text files or about 300 characters can be stored in the memory. Each stored text file can have a maximum of 60 characters.

Since a copy of the stored text file is recalled when the **Recall** function is used, the text can be edited or printed without changing the originally stored file. When a file is no longer needed or more space is necessary, the **Memory delete** function can be used to delete it.



 *When inserting new batteries, be sure to insert the new ones within five minutes of removing the old ones, otherwise any text files stored in the memory will be lost (unless the machine is plugged into an electrical outlet with the AC adapter).*

STORING TEXT



To store a text file:

① Hold down  and press . The message "STORE:1-9?" appears on the display.

 *If 300 characters have already been stored, the error message "MEMORY FULL!" appears in the display. If this occurs, an existing text file must be deleted before the new one can be stored.*



② Press the key ( to ) of the file number where you wish to store the text. The text is stored under the selected file number and the text previously shown in the display reappears.

 *If a file is already stored under the selected file number, the message "OVERWRITE?" appears in the display and you must decide whether or not to overwrite it (delete it from the memory and store the new one).*

*To quit the **Store** function without storing the text, hold down  and press  (or press just ).*

To overwrite the stored file with the new one:

● Press  to delete the previously stored file and store the new one under the selected number.

 *To go back and choose another file number without overwriting the text file, press , and then press the key of a different file number.*

RECALLING TEXT

To recall a text file:

① Hold down  and press . The message "RECALL:1-9?" appears on the display.

- 2 Press the key ($\overset{\text{Size}}{\text{F1}}$ to $\overset{\text{Recall}}{\text{F9}}$) of the file number containing the text that you wish to recall. The text stored under the selected file number is shown.

 To quit the **Recall** function without recalling text, hold down Code and press $\overset{\text{Recall}}{\text{F9}}$ (or press just $\overset{\text{Clear}}{\text{BS}}$).

- 3 Press \leftarrow . Any text previously entered in the display is erased and the text stored under the selected file number is recalled into the display.

DELETING A FILE

To delete a text file:

- 1 Hold down Code and press $\overset{\text{M.Del}}{\text{F0}}$. The message "M.DEL:1-9?" appears on the display.

- 2 Press the key ($\overset{\text{Size}}{\text{F1}}$ to $\overset{\text{Recall}}{\text{F9}}$) of the file number containing the text that you wish to delete. The text stored under the selected file number is shown.

 To cancel the **Memory delete** function without deleting the text file, hold down Code and press $\overset{\text{Recall}}{\text{F9}}$ (or press just $\overset{\text{Clear}}{\text{BS}}$).

- 3 Press \leftarrow to delete the text file that was selected.

EXAMPLE

To store text under file number 4:

- 1 Hold down Code and press $\overset{\text{Store}}{\text{F8}}$.

Caps $\overset{\text{A}}{\text{A}} \overset{\text{A}}{\text{A}} \overset{\text{A}}{\text{A}} \overset{\text{A}}{\text{A}} \overset{\text{A}}{\text{A}} \overset{\text{Auto}}{\text{A}}$
 STORE:1-9?
 Style Underline Frame Big

- 2 Press $\overset{\text{Frame}}{\text{F4}}$.

Caps $\overset{\text{A}}{\text{A}} \overset{\text{A}}{\text{A}} \overset{\text{A}}{\text{A}} \overset{\text{A}}{\text{A}} \overset{\text{A}}{\text{A}} \overset{\text{Auto}}{\text{A}}$
 4?
 Style Underline Frame Big

- 3 Press \leftarrow .

Caps $\overset{\text{A}}{\text{A}} \overset{\text{A}}{\text{A}} \overset{\text{A}}{\text{A}} \overset{\text{A}}{\text{A}} \overset{\text{A}}{\text{A}} \overset{\text{Auto}}{\text{A}}$
 John Smith_
 Style Underline Frame Big

To recall the text from file number 4:

1 Hold down **Code** and press $\begin{matrix} \text{Recall} \\ 1 \\ 9 \end{matrix}$.

Caps $\begin{matrix} A & \underline{A} & \overline{A} & \boxed{A} & \big A & \text{Auto} \\ \uparrow \\ \text{RECALL:1-9?} \\ \downarrow \\ \text{Style} & \text{Underline} & \text{Frame} & \text{Big} \end{matrix}$

2 Press $\begin{matrix} \text{Frame} \\ 5 \\ 4 \end{matrix}$.

Caps $\begin{matrix} A & \underline{A} & \overline{A} & \boxed{A} & \big A & \text{Auto} \\ \uparrow \\ 4? \text{ John Smith} \\ \downarrow \\ \text{Style} & \text{Underline} & \text{Frame} & \text{Big} \end{matrix}$

3 Press \leftarrow .

Caps $\begin{matrix} A & \underline{A} & \overline{A} & \boxed{A} & \big A & \text{Auto} \\ \uparrow \\ \underline{\text{John Smith}} \\ \downarrow \\ \text{Style} & \text{Underline} & \text{Frame} & \text{Big} \end{matrix}$

To delete the text stored under file number 4:

1 Hold down **Code** and press $\begin{matrix} \text{M.Del} \\ 1 \\ 0 \end{matrix}$.

Caps $\begin{matrix} A & \underline{A} & \overline{A} & \boxed{A} & \big A & \text{Auto} \\ \uparrow \\ \text{M.DEL:1-9?} \\ \downarrow \\ \text{Style} & \text{Underline} & \text{Frame} & \text{Big} \end{matrix}$







2 Press $\begin{matrix} \text{Frame} \\ 5 \\ 4 \end{matrix}$.

Caps $\begin{matrix} A & \underline{A} & \overline{A} & \boxed{A} & \big A & \text{Auto} \\ \uparrow \\ 4? \text{ John Smith} \\ \downarrow \\ \text{Style} & \text{Underline} & \text{Frame} & \text{Big} \end{matrix}$







3 Press \leftarrow .

Caps $\begin{matrix} A & \underline{A} & \overline{A} & \boxed{A} & \big A & \text{Auto} \\ \uparrow \\ \text{—} \\ \downarrow \\ \text{Style} & \text{Underline} & \text{Frame} & \text{Big} \end{matrix}$

TROUBLESHOOTING

Problem	Remedy
1. The display stays blank after you have turned on the machine.	<ul style="list-style-type: none"> • Check that the AC adapter is connected correctly. • If you are using batteries, check that they are correctly inserted. • If the batteries are low, replace them with new ones.
2. The machine does not print or the printed characters are blurred.	<ul style="list-style-type: none"> • Check that the tape cassette has been inserted properly. • If the tape cassette is empty, replace it with a new one. • Make sure that the tape compartment cover has been closed.
3. The text files that you stored in the memory are no longer there.	If the batteries are low, replace them with new ones.
4. The printed characters are not formed properly.	If you are using batteries, they may be low. Try using the AC adapter or replace the batteries with new ones.
5. A blank horizontal line appears through the printed label.	Clean the print head as explained on page 8.
6. Striped tape appears.	You have reached the end of the tape. Replace the tape cassette with a new one.
7. The machine has "locked up" (i.e., nothing happens when a key is pressed, even though the machine is on.)	<p>Turn off the machine, and then while holding down  and , press  to turn the machine back on.</p> <p>Finally, release  and .</p> <p> <i>The text and formats in the display and all text files stored in the memory are erased.</i></p>

ERROR MESSAGE LIST

Error Message	Cause	Remedy
2 LINE LIMIT!	This message appears if two lines already exist when you press  .	Limit the number of lines to two.
BATTERY WEAK!	This message appears when the installed batteries become weak.	Replace the batteries or use the AC adapter.
BUFFER EMPTY!	<ul style="list-style-type: none"> • This message appears if you try to print, but no text has been entered. • This message appears if you hold down  and press , but no text has been entered in the display. • This message appears if you hold down  and press , but no text has been entered in the display. • This message appears if you hold down  and press , but no text has been entered in the display. 	<ul style="list-style-type: none"> • Enter text before printing. • Enter some text before starting the function. • Enter some text before starting the function. • Enter some text before starting the function.
BUFFER FULL!	This message appears if you try to enter a character, symbol, accent, return or space after 60 characters have already been entered.	Delete some existing text so that more text can be entered.
CHANGE ADAPTER	This message appears if a high-voltage adapter is being used.	Remove the high-voltage adapter and connect the adapter designed exclusively for this machine.

Error Message	Cause	Remedy
CUTTER ERROR!	This message appears if the tape cutter lever is pressed down while a label is being printed.	Release the tape cutter lever.
INVAL. CHRS!	This message appears if the cursor is not below a number when you hold down Code and press A .	Move the cursor below a number before holding down Code and press A .
LINE LIMIT!	This message appears if the number of lines in the text is greater than the maximum number of lines possible for the installed tape.	Reduce the number of lines or install a tape of greater width.
MEMORY FULL!	This message appears if you try to store a text file after 300 characters have already been stored in the memory.	Delete an unwanted file to make room for the new one.
NO FILES!	This message appears if you try to recall or delete a text file from the memory when none are stored.	Store a text file first.
NO TAPE!	This message appears if you try to print a label or feed the tape when no tape cassette is installed.	Install a tape cassette and try again.
TOO SMALL!	This message appears if the number that is set to be printed using the Numbering function is less than the number above the cursor.	Press the key of a number that is greater than the number in the text.

SPECIFICATIONS

HARDWARE

- Input Device:** Keyboard - 49 keys
- LCD:** 7 × 5 dots
15 characters × 1 line
11 indicators
- Print Tape:** Pressure-sensitive, Adhesive-based
26' 3" (8 m) long
Four widths available:
 1/4" (6 mm)
 3/8" (9 mm)
 1/2" (12 mm)
 3/4" (18 mm)
- Power Supply:** Six AA batteries (AA/SUM-3/AM3/R6/LR6) or optional AC adapter
Auto power-off if no key is pressed for 5 minutes
- Print Head:** 64 dot / 180 dpi
- Dimensions:** 6 9/10" (W) × 7 9/10" (D) × 2" (H)
(176 × 201.5 × 52 mm)
- Weight:** 1.4 lbs (650 g) (without a tape cassette and batteries installed)

SOFTWARE

- Buffer Size:** Maximum 60 characters
Maximum two lines
- Memory Size:** 300 characters
- Character Size:** Six sizes (AUTO, SIZE1, SIZE2, SIZE3, SIZE4, SIZE5)
+ Big (only when 3/4" (18 mm) tape installed)
- Print Styles:** Normal, Outline, Bold, Shadow
(each can be combined with Italic), and Vertical

ACCESSORIES

● Supplies

Obtain tape cassettes from your nearest authorized dealer.

Use only Brother TZ tapes with this machine. Brother cannot be held responsible for trouble caused by the use of unauthorized supplies. Do not use tapes that do not have the  mark.

Stock No.	Description	QTY/ PACKAGE	PRICE
3/4" (18mm)-wide laminated tapes			
TZ-141	Black characters on clear adhesive	1	\$20.99
TZ-145	White characters on clear adhesive	1	\$20.99
TZ-241	Black characters on white adhesive	1	\$20.99
TZ-242	Red characters on white adhesive	1	\$20.99
TZ-243	Blue characters on white adhesive	1	\$20.99
TZ-344	Gold characters on black adhesive	1	\$24.99
TZ-345	White characters on black adhesive	1	\$23.99
TZ-441	Black characters on red adhesive	1	\$20.99
TZ-541	Black characters on blue adhesive	1	\$20.99
TZ-545	White characters on blue adhesive	1	\$23.99
TZ-641	Black characters on yellow adhesive	1	\$20.99
TZ-741	Black characters on green adhesive	1	\$20.99
TZ-B41	Black characters on fluorescent orange adhesive	1	\$24.99
TZ-M41	Black characters on clear (matte) adhesive	1	\$23.99
TZ-S241	Industrial (strong adhesive) black characters on white adhesive	1	\$21.99
1/2" (12mm)-wide laminated tapes			
TZ-131	Black characters on clear adhesive	1	\$16.99
TZ-231	Black characters on white adhesive	1	\$17.99
TZ-232	Red characters on white adhesive	1	\$17.99
TZ-335	White characters on black adhesive	1	\$20.99
TZ-S231	Industrial (strong adhesive) black characters on white adhesive	1	\$18.99
3/8" (9mm)-wide laminated tapes			
TZ-121	Black characters on clear adhesive	1	\$14.99
TZ-221	Black characters on white adhesive	1	\$16.99

Stock No.	Description	QTY/ PACKAGE	PRICE
TZ-325	White characters on black adhesive	1	\$18.99
TZ-421	Black characters on red adhesive	1	\$16.99
TZ-S221	Industrial (strong adhesive) black characters on white adhesive	1	\$17.99
1/4" (6mm)-wide laminated tapes			
TZ-111	Black characters on clear adhesive	1	\$12.99
TZ-211	Black characters on white adhesive	1	\$14.99
TZ-315	White characters on black adhesive	1	\$17.99
TZ-S211	Industrial (strong adhesive) black characters on white adhesive	1	\$15.99

Special tapes

Stock No.	Description	QTY/ PACKAGE	PRICE
TZ-SE4	Black characters on 3/4" (18 mm) security adhesive	1	\$29.99
TZ-FA3	Blue characters on 1/2" (12 mm) fabric adhesive	1	\$24.99

Options

Stock No.	Description	QTY/ PACKAGE	PRICE
AD-30	AC adapter	1	\$24.99
TZ-CL4	Print head cleaning cassette	1	\$20.99

P-TOUCH ACCESSORY ORDER FORM

Dear Customer:

This order form is provided for your convenience should your retailer not stock the item(s) needed. To order by mail, send this completed form along with proper payment to the address below OR credit card holders: Call toll-free 1-888-879-3232, fax completed order form to 1-800-947-1445, or visit our web site at <http://www.brothermall.com>. Please refer to the Accessories listing in your User's Guide for stock no. and price.

Stock No.	Description	Price	Quantity	Total
Subtotal				

Name: _____ **Accessory Subtotal:** \$ _____
 Address: _____ AZ, CA, CO, CT, FL, GA, IL, LA, MA,
 City: _____ MD, MI, MN, MO, NC, NJ, NV, NY,
 State/Zip: _____ OH, PA, TN, TX, VA, WA residents
 Daytime Phone: _____ add applicable sales tax \$ _____

Shipping/Handing Options

Please choose one:
 • Standard (\$5.00)
 • 2nd day air freight (\$8.75) Mandatory for all deliveries outside of the continental U.S. (Alaska, Hawaii, Puerto Rico, Virgin Islands & Canada)
 • All other overseas orders (\$25.00) \$ _____
TOTAL DUE (US dollars) \$ _____

SEND ORDER FORM TO:
 Brother International Corp.
 Attn: Consumer Accessory Div.
 P.O. Box 341332
 Bartlett, TN38184-1332

Method of payment (Check one)
 Visa MasterCard Discover American Express Check/Money Order
 Account Number _____
 Expiration Date _____
 Signature _____

* Prices subject to change without notice.



P-TOUCH ACCESSORY ORDER FORM

Dear Customer:

This order form is provided for your convenience should your retailer not stock the item(s) needed. To order by mail, send this completed form along with proper payment to the address below OR credit card holders: Call toll-free 1-888-879-3232, fax completed order form to 1-800-947-1445, or visit our web site at <http://www.brothermall.com>. Please refer to the Accessories listing in your User's Guide for stock no. and price.

Stock No.	Description	Price	Quantity	Total
Subtotal				

Name: _____
 Address: _____
 City: _____
 State/Zip: _____
 Daytime Phone: _____

Accessory Subtotal: \$ _____
 AZ, CA, CO, CT, FL, GA, IL, LA, MA,
 MD, MI, MN, MO, NC, NJ, NV, NY,
 OH, PA, TN, TX, VA, WA residents
 add applicable sales tax \$ _____

SEND ORDER FORM TO:

Brother International Corp.
 Attn: Consumer Accessory Div.
 P.O. Box 341332
 Bartlett, TN38184-1332

Shipping/Handing Options

Please choose one:
 • Standard (\$5.00)
 • 2nd day air freight (\$8.75) Mandatory for all deliveries outside of the continental U.S. (Alaska, Hawaii, Puerto Rico, Virgin Islands & Canada)
 • All other overseas orders (\$25.00) \$ _____
TOTAL DUE (US dollars) \$ _____

Method of payment (Check one)

() Visa () MasterCard () Discover () American Express () Check/Money Order

Account Number _____
 Expiration Date _____
 Signature _____

* Prices subject to change without notice.

BROTHER CONTACT INFORMATION

Service Center Locations

If you need a local service center, please call 1-800-284-HELP (4357) to locate the authorized service center closest to you.

Note: Be sure to call the Service Center before your visit.

Service centers do not provide operational assistance. See "Operational Assistance."

Operational Assistance

For technical and operational assistance you may call Brother Customer Service at: Voice 1-877-4-Print, or Fax 1-901-379-1210

Assistance on the Internet

For product information and downloading the latest drivers: <http://www.brother.com>
For purchasing accessories and certain Brother products: <http://www.brothermall.com>

Accessories and Supplies

To order Brother accessories or supplies by Visa, MasterCard, Discover or American Express you may call toll free 1-888-879-3232, or complete the order form in your user's guide and fax both sides of the form to 1-800-947-1445

For purchasing accessories on the Internet: <http://www.brothermall.com>

To order by mail or pay by check, please complete the accessory order form and mail it along with payment to:

Brother International Corporation

Attn: Consumer Accessory Division

P.O. Box 341332

Bartlett, TN 38184-1332

Fax-Back System

Brother Customer Service has installed an easy to use Fax-Back System so you can get instant answers to common technical questions and product information for all Brother products.

This system is available 24 hours a day, 7 days a week. You can use the system to send the information to any fax machine, not just the one you are calling from.

Please call 1-800-521-2846 and follow the voice prompts to receive faxed instructions on how to use the system and an index of Fax-Back subjects.

***GUIA DE
INSTRUCCIONES***

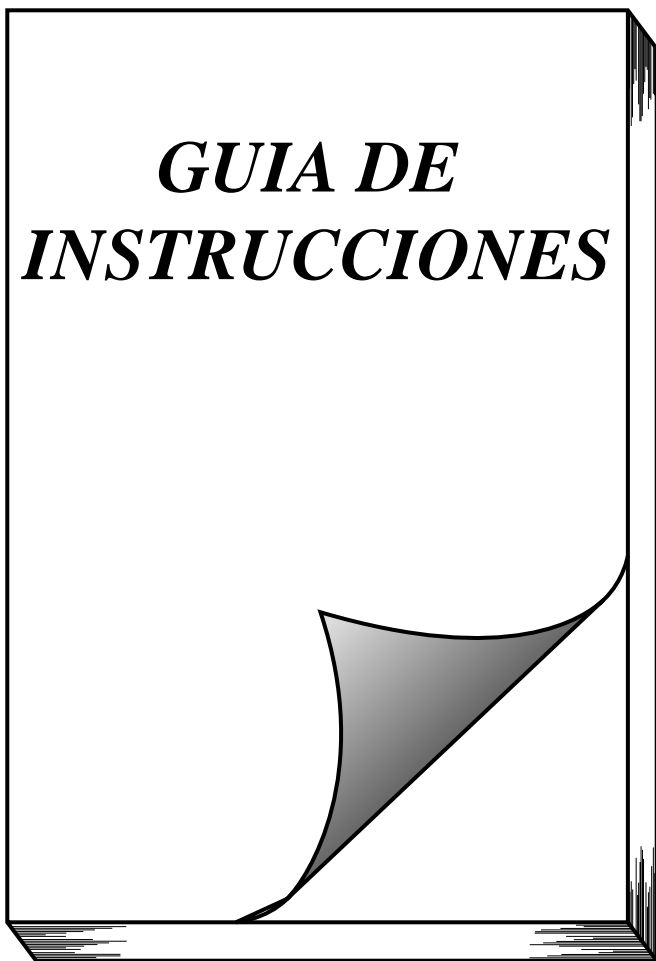

INTRODUCCIÓN

Gracias por adquirir una P-touch 1750.

Su nueva P-touch le permitirá diseñar y crear etiquetas para cualquier tipo de aplicación. Su versatilidad le permitirá crear etiquetas personales seleccionando distintos diseños de marcos y muchos tamaños y estilos de caracteres. Además, los cuatro diferentes anchos de cinta (1/4" (6 mm), 3/8" (9 mm), 1/2" (12 mm) y 3/4" (18 mm)) y la variedad de los colores de la cintas le hará posible imprimir etiquetas personales, útiles para relleno con código de colores.

Ya no hay por qué preocuparse por tareas urgentes que requieren impresión profesional. En la oficina, la fábrica, el laboratorio, o en casa, la calidad y el rendimiento de la P-touch 1750 la convierten en una máquina muy versátil y práctica.

Para terminar, puesto que esta guía del usuario le será de gran utilidad, le aconsejamos que la guarde en un lugar a mano para poder consultarla en cualquier momento.

AVISO DE LA FCC

Este equipo ha sido probado y cumple con los límites de un aparato digital de la Clase B, siguiendo el apartado 15 de las normas de la FCC. Estos límites están pensados para proporcionar una protección razonable contra interferencias nocivas dentro de una instalación residencial. Este equipo podría interferir de forma nociva con comunicaciones por radio si no se instala y utiliza siguiendo las instrucciones. No obstante, no existe ninguna garantía de que no vayan a suceder interferencias en una instalación concreta. Si este equipo causara interferencias nocivas con la recepción de radio o televisión, lo cual puede determinarse poniendo el equipo en ON u OFF, se recomienda que el usuario intente corregir dichas interferencias mediante una de las siguientes medidas:

- Reoriente o ponga la antena receptora en otro lugar.
- Aumente la separación entre el equipo y el receptor.
- Conecte el equipo en una toma de un circuito diferente de la que esté conectada el receptor.
- Consulte a su distribuidor o a un técnico experimentado de radio/televisión.
- Los cambios o modificaciones no aprobadas expresamente por Brother Industries, Ltd. podrán anular la autorización que el usuario tiene para utilizar el equipo.

A continuación se indican los números de patente y de publicación de patente relacionados con este producto:

USP4839742	USP4983058	USP5120147
USP4927278	USP5009530	
USP4976558	USP5069557	

ÍNDICE

PRECAUCIONES GENERALES	2
PILAS	2
ADAPTADOR DE CA OPCIONAL	3
CASETES DE CINTA	4
COLOCACIÓN DE ETIQUETAS	5
CABEZAL DE IMPRESIÓN Y RODILLOS	6
TECLA DEL CURSOR	7
TECLAS CODE Y SHIFT	7
TECLA DE RETORNO	8
TECLA DE BORRADO (BS)	9
FUNCIÓN DE REPOSICIÓN (CLEAR)	9
FUNCIÓN DE ACENTOS	10
FUNCIÓN DE SÍMBOLOS	10
FUNCIÓN DE TAMAÑO	11
FUNCIÓN DE ESTILO	11
FUNCIÓN DE SUBRAYADO	12
FUNCIÓN DE MARCOS	13
FUNCIÓN DE TAMAÑO GRANDE	13
FUNCIÓN DE CINTA	14
FUNCIÓN DE IMPRESIÓN DE ESPEJO	15
FUNCIÓN DE LA TECLA DE IMPRESIÓN Y AVANCE	15
FUNCIÓN DE NUMERACIÓN	16
FUNCIÓN DE IMPRESIÓN REPETIDA	16
FUNCIONES DE LA MEMORIA	17
SOLUCIÓN DE PROBLEMAS	19
LISTA DE MENSAJES DE ERROR	20
ESPECIFICACIONES	22
ACCESORIOS	23

PRECAUCIONES GENERALES

- Con esta máquina emplee sólo cintas TZ Brother. No emplee cintas que no tengan la marca .
- No tire de la cinta que se alimenta desde la P-touch. Podría dañar el casete de cinta.
- No utilice la máquina en lugares polvorientos, y manténgala alejada de la luz solar directa y la lluvia.
- No exponga la máquina a altas temperaturas ni humedad. No la deje nunca en el tablero de instrumentos ni en la parte trasera de su automóvil.
- No deje nada que sea de goma o vinilo encima de la máquina durante períodos prolongados. Podría producir manchas.
- No limpie la máquina con alcohol ni con otros solventes orgánicos. Emplee solamente un paño suave y seco.
- No ponga ningún objeto encima ni dentro de la máquina.
- Para evitar daños, no toque el borde de la cuchilla.
- Cuando inserte pilas nuevas, asegúrese de hacerlo antes de que transcurran cinco minutos desde el momento en que extrae las pilas gastadas, porque de lo contrario se perderían todos los archivos de texto (a menos que la máquina esté enchufada a una toma de CA con el adaptador de CA).
- Emplee sólo el adaptador de CA (modelo AD-30) exclusivamente diseñado para esta máquina. El empleo de otro cancelaría la garantía.
- No intente desmontar el adaptador de CA.
- Cuando la máquina no se utilice durante períodos prolongados de tiempo y no sea necesario conservar los archivos de texto en la memoria, desenchufe el adaptador de CA, y saque las pilas para evitar fugas de las mismas que podrían ser causa de daños en la máquina.
- Cuando el adaptador de CA esté enchufado en la máquina, si se desenchufa el adaptador de la toma de CA se correrá el riesgo de perder todos los archivos de texto de la memoria, aunque las pilas estén insertadas.
- **En esta máquina, emplee seis pilas del tamaño AA.**
- Para evitar daños durante el transporte, el panel LCD está cubierto con una lámina de protección transparente. Retire esta lámina de protección transparente antes de empezar a utilizarlo.

PILAS

Esta máquina ligera y portátil puede utilizarse en cualquier lugar instalando seis (6) **pilas AA**. Cuando cambie las pilas, reemplace siempre las seis pilas al mismo tiempo.

Para cambiar las pilas:

- 1 Extraiga la cubierta del compartimiento de las pilas de la parte posterior de la máquina.
- 2 Si ya hay pilas instaladas, extraígalas.
- 3 Inserte seis pilas AA nuevas, asegurándose de que quedan orientadas en la dirección correcta.
- 4 Coloque la cubierta del compartimiento de las pilas.



Asegúrese de insertar las pilas nuevas antes de que transcurran cinco minutos desde que se extraen las pilas gastadas, porque de lo contrario el texto que se visualiza en la pantalla y los archivos de texto almacenados en la memoria se perderían (a menos que la máquina esté enchufada a una toma de CA con el adaptador de CA).

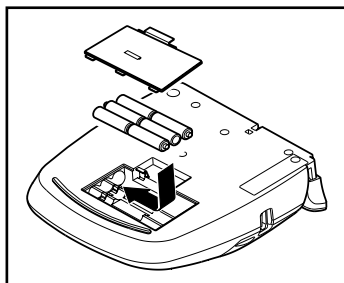

ADAPTADOR DE CA OPCIONAL

El adaptador de CA (modelo AD-30) le permite emplear esta máquina siempre que disponga de una toma de corriente eléctrica.

Para conectar el adaptador de CA opcional:

- 1 Inserte la clavija del adaptador en el conector que tiene la marca DC IN 7.0V al lado derecho de la máquina.
- 2 Inserte la clavija del adaptador de CA en la toma de corriente más cercana.



Emplee sólo el adaptador de CA diseñado exclusivamente para esta máquina.

Extraiga las pilas y desconecte el adaptador de CA si no se propone utilizar la máquina durante períodos de tiempo prolongados.

Cuando se desconecta la alimentación, se pierden el texto que se muestra en la pantalla y el que está almacenado en la memoria.

Se recomienda emplear el adaptador de CA para imprimir tipos de caracteres grandes y códigos de barras con cintas de 18 mm (3/4") porque esta operación puede gastar las pilas con rapidez.

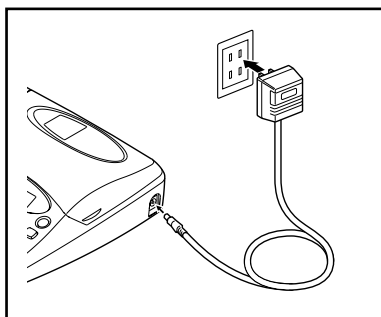

CASETES DE CINTA

Un casete de TZ se suministra con la unidad. Sin embargo, para esta máquina hay disponibles una amplia gama de cassetes de cinta TZ de distintos colores y tamaños, es posible crear etiquetas diferentes codificadas por colores o tamaños.

Para cambiar el casete de cinta:

- 1 Levante la cubierta del compartimiento de la cinta para abrirla. Se libera también entonces el casete instalado.
- 2 Si ya hay un casete instalado, extráigalo tirando del mismo recto hacia arriba.
- 3 Si la cinta entintadora del otro casete se afloja, utilice un dedo para bobinar la rueda dentada en el sentido de la flecha de dicho casete hasta tensar la cinta. Además, cerciórese de que el extremo de la cinta esté debajo de las guías de la misma.

☞ *Si está utilizando un casete de cinta nuevo provisto de retén, cerciórese de extraer éste.*

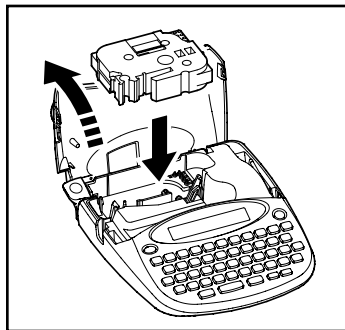

- 4 Inserte firmemente el casete de cinta en el compartimiento de la cinta asegurándose de que toda la parte posterior del casete está en contacto con la inferior del compartimiento.
- ☞ *Cuando inserte el casete de cinta, asegúrese de que la cinta interior no esté enganchada en la esquina de la guía metálica.*
- 5 Cierre la cubierta del compartimiento y conecte la alimentación de la máquina si estaba desconectada.
- 6 Mantenga pulsada **Code** y presione **Feed Space** una vez para que la cinta avance y así quede con la tensión óptima.
- 7 Presione la palanca de la cuchilla de la cinta para cortar la cinta sobrante.

COLOCACIÓN DE ETIQUETAS

VARILLA

En el lado derecho de la tapa del compartimiento de la cinta de la P-touch hay una varilla. Utilícela para pegar cinta laminada en un objeto.

- ❶ Abra la tapa del compartimiento de la cinta.
- ❷ Empuje la punta de la varilla hacia usted con el dedo.
- ❸ Tome la varilla por la punta y tire de ella hacia arriba para sacarla.

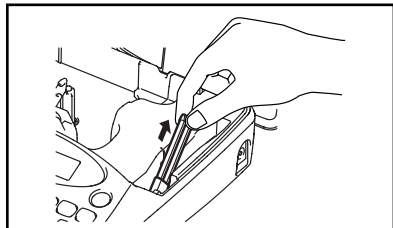
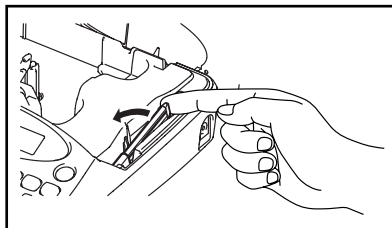

CINTA LAMINADA

La varilla suministrada permite que, en las cintas laminadas, usted pueda extraer fácilmente el papel del dorso de la etiqueta.

- ❶ Tome la cinta con la mano izquierda, con la superficie impresa arriba, y tome la varilla con la mano derecha.
- ❷ Pase la mitad de la cinta por el orificio estrecho largo de la varilla.
- ❸ Gire tres cuartos de vuelta la varilla hacia usted y separe la varilla de usted como se muestra abajo.
- ❹ Pele el papel del dorso de la etiqueta.

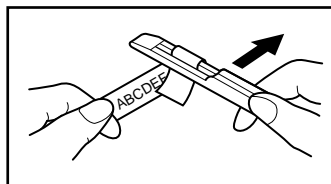
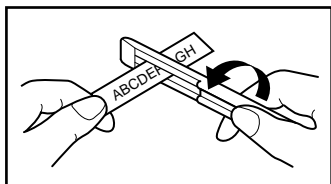

CINTAS DE TELA

La cinta de tela se emplea para adherir un trozo de tela impresa con el texto en prenda de vestir empleando una plancha. Después de imprimir el texto en la cinta de tela y de haber cortado la etiqueta empleando unas tijeras, coloque la etiqueta sobre una prenda planchada en la posición el la que desee ponerla de modo que el texto impreso pueda leerse correctamente. Cubra la etiqueta con otra tela y emplee un ajuste de la plancha de temperatura medio-alta (320 a 356°F (160 a 180 °C)) para presionar con firmeza durante 10 a 15 segundos. Para más detalles, consulte las instrucciones suministradas con el casete de cinta de tela.

CABEZAL DE IMPRESIÓN Y RODILLOS

De vez en cuando, motas de polvo o suciedad se adhieren al cabezal de impresión y a los rodillos de la máquina. Suele suceder cuando se emplea la unidad en exteriores o en lugares con mucho polvo. Si alguna parte del cabezal de impresión está cubierta de polvo, es posible que aparezca una franja horizontal blanca por el texto de la etiqueta.

Por lo tanto, al igual que con las grabadoras de cintas, el cabezal de la máquina deberá limpiarse de vez en cuando.

Para limpiar el cabezal de impresión y los rodillos:

- 1 Desconecte la alimentación de la máquina.
- 2 Abra la cubierta del compartimiento de la cinta, extraiga el casete, si está dentro. El cabezal de impresión y los rodillos están situados dentro del compartimiento de la cinta.
- 3 Cabezal de impresión: Emplee un palillo con punta de algodón seco para frotar con cuidado el cabezal de impresión con movimiento hacia arriba y abajo.
Rodillos: Emplee un palillo con punta de algodón seco para frotar cada rodillo con movimiento hacia arriba y abajo mientras los gira con el dedo.
- 4 Pruebe de nuevo la impresión.

Si todavía queda polvo:

- 5 Repita el paso 3 empleando un palillo con cabeza de algodón humedecido en alcohol isopropílico (limpieza).

Si no funciona nada de lo de arriba, póngase en contacto con el representante de servicio.

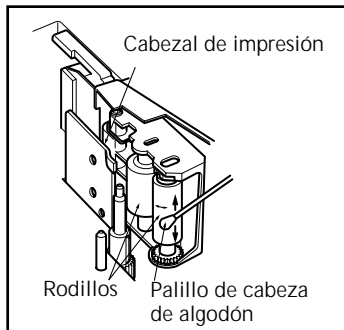
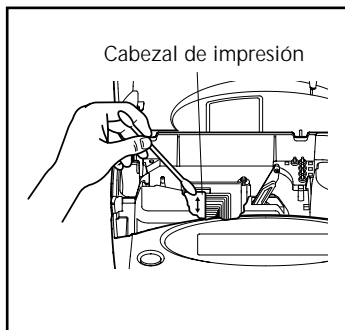

La limpieza también puede hacerse utilizando el casete de limpieza de cabezales de impresión opcional (TZ-CL4).

TECLA DEL CURSOR

El visualizador de LCD de esta máquina muestra una fila de 15 caracteres; sin embargo, el texto que usted cree puede tener hasta 60 caracteres de longitud. Podrá revisar y editar el texto empleando las teclas del cursor para moverlo y que muestre las distintas partes en el visualizador.

TECLA DEL CURSOR IZQUIERDA



Para mover el cursor un carácter hacia la izquierda:

- Presione  una vez.

Para mover el cursor varios caracteres hacia la izquierda:

- Mantenga presionado  hasta que el cursor se mueva a la posición deseada.

Para mover el cursor al principio de la línea de texto:

- Mantenga presionado  y presione .

TECLA DEL CURSOR DERECHA



Para mover el cursor un carácter hacia la derecha:

- Presione  una vez.

Para mover el cursor varios caracteres hacia la derecha:

- Mantenga presionado  hasta que el cursor se mueva a la posición deseada.

Para mover el cursor al final de la línea de texto:

- Mantenga presionado  y presione .

TECLAS CODE Y SHIFT

La mayoría de los caracteres pueden introducirse simplemente presionando sus teclas. Sin embargo, para emplear funciones especiales o para introducir letras en mayúsculas, caracteres acentuados y algunos símbolos, se requieren las siguientes teclas especiales.

TECLA CODE

Para emplear una función impresa encima de la tecla:

- Mantenga presionado  y presione la tecla que está inmediatamente debajo de la función deseada.





TECLA SHIFT

Para escribir una letra mayúscula o un símbolo impreso en la esquina superior izquierda de la tecla:

- Mantenga presionado  y presione la tecla de la letra o símbolo deseado.



El modo **Caps** (mayúsculas) es similar a mantener presionada . Le permite escribir letras mayúsculas continuamente.

Para escribir muchas letras mayúsculas:

- 1 Mantenga presionado  y presione . El indicador de **Caps**, de la izquierda del visualizador, se encenderá.
- 2 Presione las teclas de las letras o símbolos deseados.
- 3 Para salir del modo **Caps**, mantenga presionado  y presione . Se apagará el indicador de **Caps**.

TECLA DE RETORNO

Al igual que en una máquina de escribir o procesador de texto, la tecla de retorno () de esta máquina se emplea para poner fin a una línea de texto y empezar otra. Cuando haya terminado de introducir una línea, presione la tecla de retorno para hacer una línea nueva y mover al cursor a la misma.

 Una etiqueta sólo puede contener un máximo de dos líneas de texto. Si presiona  cuando el cursor está situado en la segunda línea, aparecerá el mensaje de error "2 LINE LIMIT!".



Número máximo de líneas que pueden imprimirse	Anchuras de cinta
1	1/4" (6 mm)
2	3/8" (9 mm), 1/2" (12 mm), 3/4" (18 mm)

La tecla de retorno también podrá utilizarse para seleccionar un ítem de una lista (p. ej., añadir un símbolo o un carácter acentuado al texto) o para aplicar un ajuste seleccionado.

Es posible que aparezcan en el visualizador de LCD algunas preguntas para que confirme un comando, especialmente cuando la función que usted ha seleccionado es para borrar o afectar archivos. En estos casos, si presiona  es como si respondiera "sí".



 Para contestar "no", presione . Consulte la descripción de la TECLA DE BORRADO (BS) de la página 9.

TECLA DE BORRADO (BS)



La tecla de borrado () le permite eliminar caracteres situados a la izquierda de la posición actual del cursor. Se diferencia de la tecla del cursor izquierda () que sólo mueve el cursor sin borrar ningún carácter.

La tecla de borrado también puede utilizarse para abandonar la mayor parte de funciones y volver a la visualización anterior sin cambiar el texto.

Es posible que aparezcan en el visualizador de LCD algunas preguntas para que confirme un comando, especialmente cuando la función que usted ha seleccionado es para borrar o afectar archivos. En estos casos, si presiona  es como si respondiera "sí".

 Para contestar "no", presione . Consulte la descripción de la **TECLA DE RETORNO** de la página 8.

Para borrar un carácter:



- 1 Presione  o  para situar el cursor debajo del carácter que está inmediatamente a la derecha del carácter que usted desea borrar.
- 2 Presione  una vez.

FUNCIÓN DE REPOSICIÓN (CLEAR)

Si borra la visualización antes de introducir nuevo texto, la función **Reposición** podrá utilizarse para elegir si se desea borrar todo el texto.

 La función **Borrar** solamente borrará texto. Las funciones de formato (**Tamaño**, **Estilo**, **Subrayado**, **Marco**, **Tamaño grande**, **Margen de la cinta**, y **Impresión de espejo**) no volverán a sus ajustes iniciales, sino que seguirán como estén.

Para borrar todo el texto y reponer todos los formatos a sus ajustes iniciales:









- 1 Mantenga presionado  y presione .
- 2 Se borrará todo el texto.

FUNCIÓN DE ACENTOS

La función de **acentos** también podrá utilizarse para añadir caracteres acentuados al texto. Los caracteres acentuados se agrupan de acuerdo con la letra mayúscula o minúscula con la que se combinan. Hay disponibles los siguientes caracteres acentuados:

Letras	Caracteres acentuados	Letras	Caracteres acentuados
a	à á â ã ä å æ	l	ĺ ı
A	À Á Â Ã Ä Å Æ	n	ñ
c	ç	N	Ñ
C	Ç	o	ó ô õ ö
e	è é ê ë ì	O	Ó Ô Õ Ö
E	È É Ê Ë Ì	u	ù ú û ü
i	í î ï	U	Û Ü Û Ü

Para escribir un carácter acentuado:

- Mantenga presionado  y presione . Aparecerá el mensaje "A-U?" en el visualizador.
- Presione la tecla de la letra acentuada deseada.
 *Para escribir una letra mayúscula, mantenga pulsada  (o mantenga pulsada  y presione  para pasar al modo de mayúsculas) antes de pulsar la tecla de la letra.*
- Presione  o  hasta que el cursor se coloque debajo del carácter acentuado deseado.
- Presione . La letra acentuada se añadirá al texto.



FUNCIÓN DE SÍMBOLOS

Además de letras, de los símbolos y los números de las teclas, hay 48 marcas adicionales con la función de símbolos.

Los siguientes símbolos están disponibles:

Para escribir un símbolo:

- Presione . Aparecerá el mensaje "1-4?" en el visualizador.
- Presione una tecla de 1 a 4 para elegir el juego que contenga el símbolo deseado.

- 3 Presione  o  hasta que el cursor se coloque debajo del símbolo deseado.
- 4 Presione . El símbolo aparecerá en el texto.

FUNCIÓN DE TAMAÑO





El tamaño de los caracteres puede ajustarse empleando las funciones de **tamaño** (Size). La tabla siguiente indica los tamaños de caracteres.



Tamaño	Carácter
SIZE 1	Tamaño base
SIZE 2	Dos veces más ancho que el tamaño base
SIZE 3	Dos veces más alto que el tamaño base
SIZE 4	Cuatro veces más ancho que el tamaño base
SIZE 5	Cuatro veces más alto que el tamaño base
AUTO	Cinta de 1/4" (6 mm): SIZE 1 Cinta de 3/8" a 3/4" (9 mm a 18 mm): SIZE 4

El ajuste del tamaño de ajuste inicial es **AUTO**. El tamaño y el ancho actualmente seleccionados siempre se indican con los indicadores de encima del visualizador.

Cuando se instale cinta de 6 mm y esté ajustado SIZE 3, 4 y 5 para impresión horizontal o SIZE 2, 4 y 5 para impresión vertical, se visualizará el mensaje "CHR_SIZE:AUTO?". Presione  para imprimir en el tamaño **AUTO**.

Para cambiar el ajuste del tamaño:

- 1 Manteniendo presionada , pulse una vez , y mantenga presionada  para hacer que se visualice el tamaño actualmente ajustado.
- 2 Siguiendo manteniendo presionada , continúe presionando  hasta que se visualice el tamaño actualmente ajustado mediante el indicador del mismo.

 *El ajuste del tamaño actual también se mostrará en el indicador de tamaño situado sobre el visualizador.*
- 3 Para aplicar el ajuste de tamaño seleccionado a todo el texto, suelte .

FUNCIÓN DE ESTILO

Podrá seleccionar entre doce estilos de caracteres distintos que podrá aplicar a su texto.

 *Los caracteres que se imprimen utilizando los tamaños más pequeños pueden resultar difíciles de leer si se seleccionan ciertos ajustes de estilos (por ejemplo, (ITALIC+SHADOW).*

Hay disponibles los siguientes ajustes de estilos:

NORMAL

OUTLINE (perfilado)

BOLD (negrilla)

SHADOW (sombreado)

ITALIC (cursiva)

ITALIC+OUTLINE (cursiva y perfilado)

ITALIC+BOLD (cursiva y negrilla)







ITALIC+SHADOW (cursiva y sombreado)

VERTICAL

El ajuste de estilo predeterminado es **NORMAL**. El indicador de estilo de la parte inferior derecha del visualizador mostrará el ajuste de estilo actual cuando seleccione un estilo que no sea **NORMAL**.

Consulte el apartado de Referencia, al final de esta sección, para ver muestras de los ajustes disponibles.

Para cambiar el ajuste del estilo:

- 1 Manteniendo presionada , pulse una vez , y mantenga presionada  para hacer que se visualice el estilo actualmente ajustado.
- 2 Siguiendo manteniendo presionada , continúe presionando  hasta que se visualice el estilo actualmente ajustado mediante el indicador del mismo.
- 3 Para aplicar el ajuste de estilo seleccionado a todo el texto, suelte .

FUNCIÓN DE SUBRAYADO







Podrá acentuar el texto subrayándolo.

El ajuste de subrayado inicial es **OFF**. En este caso, en el visualizador no se indicará "TEXT". Cuando haya ajustado la función de **subrayado** a **UNDERLINE**, el indicador de **subrayado** de la parte derecha del visualizador se encenderá.

 *Los ajustes subrayados y encuadrados no pueden realizarse al mismo tiempo.*

ABC

Para cambiar el ajuste del subrayado:

- 1 Manteniendo presionada , pulse una vez , y mantenga presionada  para hacer que se visualice el subrayado actualmente ajustado.
- 1 Siguiendo manteniendo presionada , continúe presionando  hasta que se visualice el subrayado actualmente ajustado mediante el indicador del mismo.
 *Cuando seleccione el ajuste **UNDERLINE**, el indicador de **subrayado** se encenderá.*
- 1 Para aplicar el ajuste de subrayado seleccionado a todo el texto, suelte .

FUNCIÓN DE MARCOS

Con la función de **marcos**, podrá seleccionar diversos marcos y funciones destacadas para hacer un diseño más decorativo o una etiqueta con más énfasis.

Los ajustes de marcos siguientes están disponibles:







TEXT, ROUND, WOODEN, POINTING, CANDY

El ajuste inicial de marco es **TEXT**, aunque hay también otros ajustes. Si se selecciona cualquier ajuste que no sea **TEXT**, se encenderá el indicador de **marco**, situado a la derecha del visualizador.





Los ajustes subrayados y encuadrados no pueden realizarse al mismo tiempo.

Consulte el apartado de Referencia, al final de esta sección, para ver muestras de los ajustes disponibles.

Para cambiar el ajuste del marco:

- 1 Manteniendo presionada , pulse una vez , y mantenga presionada  para hacer que se visualice el marco actualmente ajustado.
- 2 Siguiendo manteniendo presionada , continúe presionando  hasta que se visualice el marco actualmente ajustado mediante el indicador del mismo.
*El indicador de **marco** se enciende si se selecciona un ajuste que no sea **TEXT**.*
- 3 Para aplicar el ajuste de marco seleccionado a todo el texto, suelte .

REFERENCIA

Ajustes del marco	Muestras de marco	Ajustes del marco	Muestras de marco
TEXT	ABC	POINTING	
ROUND		CANDY	
WOODEN			

FUNCIÓN DE TAMAÑO GRANDE

La función de **tamaño grande** podrá utilizarse cuando se inserte una cinta de 3/4" (18 mm) y se introduzca una línea de texto. Cuando imprima con la función de tamaño grande activada, las letras introducidas en minúsculas se imprimirán como letras mayúsculas.







OFF	ON
ABC	ABC

El ajuste inicial es **OFF**. Cuando ajuste la función de tamaño grande a **ON**, el indicador de tamaño grande se encenderá en la parte inferior izquierda del visualizador.

☞ Si cambia cualquiera de los ajustes de **Tamaño**, **Estilo**, **Subrayado**, o **Cuadro** después de haber ajustado el tamaño grande, éste volverá automáticamente al valor inicial, y tendrán preferencia los ajustes de **Tamaño**, **Estilo**, **Subrayado**, o **Cuadro**.

Si ajusta el tamaño grande cuando haya una cinta que no sea de 3/4" (18 mm) insertada, se visualizará el mensaje "CHR_SIZE:AUTO?". Presione  para imprimir en el tamaño **AUTO**.

Para cambiar el ajuste de Tamaño grande

- 1 Inserte el casete de cinta de 3/4" (18 mm) e introduzca una fila de texto.
- 2 Manteniendo presionado , presione una vez , y mantenga presionado  para que se visualice el ajuste actual.
- 3 Manteniendo presionado , presione  para realizar el ajuste **ON**.
☞ Cuando realice el ajuste **ON**, se encenderá el indicador de tamaño grande.
- 4 Para aplicar el ajuste seleccionado al texto introducido, suelte .

FUNCIÓN DE CINTA

La función de **margen cinta** le permite ajustar el tamaño de los márgenes de los lados izquierdo y derecho del texto.

El ajuste inicial de margen cinta es **FULL**, aunque hay también disponibles otros tres ajustes.

FULL (márgenes de 25 mm (1"))

NONE (márgenes de 2 mm (1/12"))

NARROW (márgenes de 4 mm (1/6"))

HALF (márgenes de 12 mm (1/2"))

☞ Después de imprimir empleando los ajustes de margen cinta **NARROW**, y **HALF**, presione la palanca de la cuchilla de la cinta para cortar la etiqueta, y emplee entonces unas tijeras para cortar a lo largo de los puntos (:) impresos para centrar el texto dentro de la etiqueta.

Para cambiar el ajuste de la cinta:

- 1 Manteniendo presionada **Code**, pulse una vez **Code**^{Tape}, y mantenga presionada **Code** para hacer que se visualice la cinta actualmente ajustado.
- 2 Siguiendo manteniendo presionada **Code**, continúe presionando **Code**^{Tape} hasta que se visualice la cinta actualmente ajustado mediante el indicador del mismo.
- 3 Para aplicar el ajuste de la cinta seleccionado a todo el texto, suelte **Code**.

FUNCIÓN DE IMPRESIÓN DE ESPEJO

Con esta función, podrá imprimir el texto de modo que los caracteres puedan leerse desde el lado del adhesivo de la cinta. Si se adhieren etiquetas con impresión de espejo a un vidrio, o en otro material transparente, podrán leerse correctamente desde el lado opuesto.

☞ Cuando emplee la función de **impresión de espejo**, el texto se imprimirá en cinta transparente.

El ajuste inicial para la impresión de espejo es **OFF**.

MIRROR : ON

ABC

Para activar o desactivar la impresión de espejo:

- 1 Manteniendo presionada **Code**, pulse una vez **Print**^{Mirror}, y mantenga presionada **Code** para hacer que se visualice la impresión de espejo actualmente ajustado.
- 2 Siguiendo manteniendo presionada **Code**, continúe presionando **Print**^{Mirror} hasta que se visualice la impresión de espejo actualmente ajustado mediante el indicador del mismo.
- 3 Para aplicar el ajuste de la impresión de espejo seleccionado a todo el texto, suelte **Code**.

FUNCIÓN DE LA TECLA DE IMPRESIÓN Y AVANCE

Después de haber introducido el texto y de haber seleccionado los ajustes del formato deseado, estará preparado para la impresión.

Para imprimir una etiqueta:

- Presione una vez **Print**^{Mirror}. Se visualizará "PRINTING".

Para hacer avanzar la cinta:

- Mantenga presionado **Print**^{Mirror} y presione **Space**^{Feed} una vez. La cinta avanzará 25 mm (1") hacia afuera.

Para cortar la cinta:







- Presione la cinta sobre la palanca de la cuchilla.



☞ *Para evitar daños en la cinta, no trate de cortarla durante la impresión ni el avance. Si presiona demasiado la palanca de la cuchilla, puede romperse.*



FUNCIÓN DE NUMERACIÓN

Esta función podrá utilizarse para imprimir muchas copias del mismo texto aumentando en 1 cierto número en el texto después de haber impreso cada etiqueta.

Para utilizar la función de numeración:

- 1 Presione  o  para colocar el cursor debajo del número que desee aumentar.
- 2 Mantenga pulsada  y presione . En el visualizador aparecerá el mensaje "NUMBER:1-9?".
- 3 Presione una tecla numérica ( a ) correspondiente al último número que desee imprimir.





☞ *Para abandonar la función de **numeración** sin imprimir, mantenga pulsada  y después presione  (o presione simplemente ).*



- 4 Para comenzar la impresión de etiquetas, presione  (o ).
- 5 Para cortar la cinta, presione la palanca del cortador de la misma, y después utilice unas tijeras para cortar a lo largo de los puntos a fin de separar las etiquetas.



FUNCIÓN DE IMPRESIÓN REPETIDA

Esta función le permite imprimir hasta 9 copias del mismo texto.



Para emplear la función de impresión repetida:

- 1 Mantenga presionado  y presione . Aparecerá el mensaje "REPEAT:1-9?" en el visualizador.
- 2 Presione la tecla numérica ( a ) correspondiente al número de etiquetas que desee.

☞ *Para abandonar la función de impresión repetida sin imprimir, mantenga pulsada  y después presione  (o presione simplemente ).*

- 3 Presione  (o ) para empezar a imprimir las etiquetas.
- 4 Presione la palanca de la cuchilla de la cinta para cortar la cinta, y emplee luego unas tijeras para cortar a lo largo de los puntos impresos para separar las etiquetas.

FUNCIONES DE LA MEMORIA

Usted podrá utilizar la memoria para almacenar sus archivos de texto más frecuentemente utilizados. El texto permanecerá en la memoria, incluso después de haberlo eliminado del visualizador utilizando la función de **borrado** (manteniendo presionada  y presionando .

Cuando almacena cada archivo, a éste se le asignará un número para poder invocarlo fácilmente. En la memoria podrá almacenar hasta 9 archivos de texto, o aproximadamente 300 caracteres. Cada archivo de texto almacenado podrá tener un máximo de 60 caracteres.

Como, cuando se invoque un archivo de texto con la función de **invocación**, se invocará una copia del archivo almacenado, el texto podrá editar o imprimirse sin cambiar el archivo originalmente almacenado. Cuando ya no necesite un archivo o cuando ya no lo necesite, podrá utilizar la función de **borrado de la memoria**.



☞ *Cuando tenga que insertar nuevas pilas, hágalo antes de cinco minutos de haber extraído las viejas, ya que de lo contrario los archivos de texto almacenados en la memoria se perderían (a menos que la máquina esté enchufada en un tomacorriente de la red con el adaptador de alimentación de CA).*

ALMACENAMIENTO DE TEXTO



Para almacenar un archivo de texto:

① Mantenga pulsada  y presione . En el visualizador aparecerá el mensaje "STORE:1-9?".

☞ *Si ya están almacenados 300 caracteres, en el visualizador aparecerá el mensaje de error "MEMORY FULL!". Cuando ocurra esto, tendrá que borrar un mensaje existente antes de poder almacenar otro nuevo.*

② Presione la tecla ( a ) correspondiente al número de archivo en el que desee almacenar texto. El texto se almacenará en el número de archivo seleccionado y el texto previamente mostrado en el visualizador desaparecerá.

☞ *Si ya hay un archivo almacenado con el número de archivo seleccionado, en el visualizador aparecerá el mensaje "OVERWRITE?", y usted tendrá que decidir entre reescribir o borrar tal archivo.*

Para abandonar la función de **almacenamiento** del texto, mantenga pulsada  y presione  (o simplemente presione .









Par reescribir un archivo almacenado con otro nuevo:

- Presione  para borrar el archivo previamente almacenado y almacenar el nuevo con el número seleccionado.

☞ *Para retroceder y elegir otro número de archivo sin reescribir el archivo de texto, presione , y después presione una tecla numérica correspondiente a un número de archivo diferente.*









INVOCACIÓN DE TEXTO

Para invocar un archivo de texto:





- 1 Mantenga pulsada  y presione , En el visualizador aparecerá el mensaje "RECALL:1-9?".
- 2 Presione la tecla ( a ) correspondiente al número de archivo que desee invocar. Aparecerá el texto almacenado con el número de archivo seleccionado.
☞ *Para abandonar la función de **invocación** sin invocar texto, mantenga pulsada  y presione  (o presione simplemente ).*
- 3 Presione . Cualquier texto previamente introducido en el visualizador se borrará y el texto introducido en el número de archivo seleccionado se invocará en el visualizador.

BORRADO DE UN ARCHIVO







Para borrar un archivo de texto:

- 1 Mantenga pulsada  y presione . En el visualizador aparecerá el mensaje "M.DEL:1-9?".
- 2 Presione la tecla ( a ) correspondiente al número de archivo que desee borrar. En el visualizador aparecerá el texto almacenado con el número de archivo seleccionado.
☞ *Para abandonar la función **borra de la memoria** sin borrar el archivo de texto, mantenga pulsada  y presione  (o presione simplemente ).*
- 3 Para borrar el archivo de texto seleccionado, presione .

SOLUCIÓN DE PROBLEMAS

Problema	Remedio
1. El visualizador se queda en blanco después de haber conectado la alimentación de la máquina.	<ul style="list-style-type: none"> • Compruebe que el adaptador de CA esté correctamente enchufado. • Si está empleando pilas, compruebe que estén correctamente insertadas. • Si las pilas están gastadas, reemplácelas por otro nuevo.
2. La máquina no imprime o los caracteres impresos quedan borrosos.	<ul style="list-style-type: none"> • Compruebe que el casete de cinta se haya insertado correctamente. • Si el casete de cinta está vacío, reemplácelo por otro nuevo. • Asegúrese de que la cubierta del casete de cinta se haya cerrado.
3. Los archivos de texto almacenados en la memoria ya no están ella.	Si las pilas están gastadas, reemplácelas por otro nuevo.
4. Los caracteres impresos no se forman correctamente.	Si está empleando pilas, quizás estén gastadas. Pruebe utilizando el adaptador de CA o reemplace las pilas por otras nuevas.
5. Aparece una línea horizontal en blanco a través de la etiqueta impresa.	Limpie el cabezal de impresión como se ha explicado en la página 6.
6. Aparecen franjas.	Se ha terminado la cinta. Reemplace el casete de cinta por otro nuevo.
7. La máquina se ha "bloqueado" (es decir, no ocurre nada cuando se pulsa una tecla aunque la máquina está encendida.)	<p>Apague la máquina, y después, mientras mantiene pulsadas  y , pulse  para volver a encenderla.</p> <p>Finalmente, suelte  y .</p> <p><i>El texto y los formatos que aparecen en el visualizador y todos los archivos de texto almacenados en la memoria se borrarán.</i></p>

LISTA DE MENSAJES DE ERROR

Mensaje de error	Causa	Remedio
2 LINE LIMIT!	Este mensaje aparece si ya existen cuatro líneas dos presiona  .	Límite el número de líneas a dos.
BATTERY WEAK!	Este mensaje aparece cuando las pilas instaladas están gastadas.	Reemplace las pilas o emplee el adaptador de CA.
BUFFER EMPTY!	<ul style="list-style-type: none"> Este mensaje aparece si intenta imprimir, pero sin haber introducido texto. Este mensaje aparece si mantiene pulsada  y presiona , pero sin haber introducido texto en el visualizador. Este mensaje aparece si mantiene pulsada  y presiona , pero sin haber introducido texto en el visualizador. Este mensaje aparece si mantiene pulsada  y presiona , pero sin haber introducido texto en el visualizador. 	<ul style="list-style-type: none"> Introduzca texto antes de la impresión. Introduzca algo de texto antes de iniciar la función. Introduzca algo de texto antes de iniciar la función. Introduzca algo de texto antes de iniciar la función.
BUFFER FULL!	Este mensaje aparece si intenta introducir un carácter, símbolo, acentos, retorno, o un espacio cuando ya se han introducido 60 caracteres.	Borre algo del texto existente para poder introducir más texto.
CHANGE ADAPTOR	Este mensaje aparece si se está empleando un adaptador de alta tensión.	Extraiga el adaptador de alta tensión y conecte el adaptador de 9,0V CA 1,2 A.
CUTTER ERROR!	Este mensaje aparecerá si presiona la palanca del cortador de cinta mientras esté imprimiéndose una etiqueta.	Suelte la palanca del cortador de cinta.

Mensaje de error	Causa	Remedio
INVAL. CHR!	Este mensaje aparecerá si el cursor está al final del texto cuando mantenga pulsada Code y presione ^{Number} A .	Mueva el cursor hasta debajo del número manteniendo pulsada Code y presione ^{Number} A .
LINE LIMIT!	Este mensaje aparece si el número de líneas del texto es mayor que el número máximo de líneas posible para la cinta instalada.	Reduzca el número de líneas o instale una cinta más ancha.
MEMORY FULL!	Este mensaje aparecerá si intenta almacenar un archivo de texto después de haber almacenado ya 300 caracteres en la memoria.	Borre un archivo que no desee para dejar espacio para el nuevo.
NO FILES!	Este mensaje aparece si intenta llamar o borrar un archivo de texto de la memoria cuando realmente no hay ninguno almacenado.	Almacene primero un archivo de texto.
NO TAPE!	Este mensaje aparecerá si intenta imprimir una etiqueta o alimentar cinta cuando haya casete de cinta instalado.	Instale un casete de cinta y pruebe de nuevo.
TOO SMALL!	Este mensaje aparecerá si el número ajustado para imprimirse utilizando la función de numeración es inferior al situado sobre el cursor.	Presione la tecla correspondiente a un número superior al del texto.

ESPECIFICACIONES

HARDWARE

Dispositivo de entrada:	Teclado de 49 teclas
LCD:	7 × 5 puntos 15 caracteres × 1 línea 11 indicadores
Cinta de impresión:	Sensible a la presión, base adhesiva, 8 m (26'3") de longitud Cuatro anchos disponibles: 6 mm (1/4") 9 mm (3/8") 12 mm (1/2") 18 mm (3/4")
Alimentación:	Seis pilas AA (AA/SUM-3/AM3/R6/LR6) o adaptador de CA opcional Desconexión automática de la alimentación si no se pulsa ninguna tecla durante 5 minutos
Cabezal de impresión:	64 puntos / 180 dpi
Dimensiones:	176 (An) × 201.5 (Prf) × 52 (Al) mm (6 9/10" × 7 9/10" × 2")
Peso:	650 g (1.4 lbs) (sin casete de cinta ni pilas instalados)

SOFTWARE

Tamaño de la memoria intermedia:	Máximo de 60 caracteres Máximo de dos líneas
Tamaño de la memoria:	300 caracteres
Tamaño de caracteres:	Seis tamaños (AUTO, SIZE1, SIZE2, SIZE3, SIZE4, SIZE5) + Grande (sólo cuando se haya instalado cinta de 18 mm (3/4"))
Estilos de impresión:	Normal, perfilado, negrilla, sombreado (todos pueden combinarse con cursiva), y Vertical

ACCESORIOS

● Accesorios de consumo

Adquiera los casetes de cinta en el distribuidor autorizado que le quede más cerca. Emplee sólo cintas Brother TZ con esta máquina. Brother no puede hacerse responsable por los problemas causados por el empleo de accesorios de consumo no autorizados. No emplee cintas que no tengan la marca .

N.º de producto	Descripción	CANT./ PAQUETE	PRECIO
Cintas laminadas de 18 mm (3/4")			
TZ-141	Caracteres negros sobre adhesivo transparente	1	\$20.99
TZ-145	Caracteres blancos sobre adhesivo transparente	1	\$20.99
TZ-241	Caracteres negros sobre adhesivo blanco	1	\$20.99
TZ-242	Caracteres rojos sobre adhesivo blanco	1	\$20.99
TZ-243	Caracteres azules sobre adhesivo blanco	1	\$20.99
TZ-344	Caracteres dorados sobre adhesivo negro	1	\$24.99
TZ-345	Caracteres blancos sobre adhesivo negro	1	\$23.99
TZ-441	Caracteres negros sobre adhesivo rojo	1	\$20.99
TZ-541	Caracteres negros sobre adhesivo azul	1	\$20.99
TZ-545	Caracteres blancos sobre adhesivo azul	1	\$23.99
TZ-641	Caracteres negros sobre adhesivo amarillo	1	\$20.99
TZ-741	Caracteres negros sobre adhesivo verde	1	\$20.99
TZ-B41	Caracteres negros sobre adhesivo naranja fluorescente	1	\$24.99
TZ-M41	Caracteres negros sobre adhesivo claro (MATE)	1	\$23.99
TZ-S241	Caracteres negros industriales (adhesivo fuerte) sobre adhesivo blanco	1	\$21.99
Cintas laminadas de 12 mm (1/2")			
TZ-131	Caracteres negros sobre adhesivo transparente	1	\$16.99
TZ-231	Caracteres negros sobre adhesivo blanco	1	\$17.99
TZ-232	Caracteres rojos sobre adhesivo blanco	1	\$17.99
TZ-335	Caracteres blancos sobre adhesivo negro	1	\$20.99
TZ-S231	Caracteres negros industriales (adhesivo fuerte) sobre adhesivo blanco	1	\$18.99
Cintas laminadas de 9 mm (3/8")			
TZ-121	Caracteres negros sobre adhesivo transparente	1	\$14.99
TZ-221	Caracteres negros sobre adhesivo blanco	1	\$16.99

N.º de producto	Descripción	CANT./ PAQUETE	PRECIO
TZ-325	Caracteres blancos sobre adhesivo negro	1	\$18.99
TZ-421	Caracteres negros sobre adhesivo rojo	1	\$16.99
TZ-S221	Caracteres negros industriales (adhesivo fuerte) sobre adhesivo blanco	1	\$17.99
Cintas laminadas de 6 mm (1/4")			
TZ-111	Caracteres negros sobre adhesivo transparente	1	\$12.99
TZ-211	Caracteres negros sobre adhesivo blanco	1	\$14.99
TZ-315	Caracteres blancos sobre adhesivo negro	1	\$17.99
TZ-S211	Caracteres negros industriales (adhesivo fuerte) sobre adhesivo blanco	1	\$15.99

Cintas especiales

N.º de producto	Descripción	CANT./ PAQUETE	PRECIO
TZ-SE4	Caracteres negros sobre cinta de seguridad de 18 mm (3/4")	1	\$29.99
TZ-FA3	Caracteres azules sobre cinta de tela de 12 mm (1/2")	1	\$24.99

Opciones

N.º de producto	Descripción	CANT./ PAQUETE	PRECIO
AD-30	Adaptador de CA	1	\$24.99
TZ-CL4	Casete de limpieza del cabezal de impresión	1	\$20.99

brother®