



brother
P-touch®
GL100
TZE
TAPE
English / Español
USER'S GUIDE
www.P-touch.com
LN7522001
Printed in China

FCC NOTICE

This device complies with Part 15 of the FCC Rules. Operation is subject to the following two conditions: (1) this device may not cause harmful interference, and (2) this device must accept any interference received, including interference that may cause undesired operation.

This equipment has been tested and found to comply with the limits for a Class B digital device, pursuant to Part 15 of the FCC Rules. These limits are designed to provide reasonable protection against harmful interference in a residential installation. This equipment generates, uses, and can radiate radio frequency energy and, if not installed and used in accordance with the instructions, may cause harmful interference to radio communications. However, there is no guarantee that interference will not occur in a particular installation. If this equipment does cause harmful interference to radio or television reception, which can be determined by turning the equipment off and on, the user is encouraged to try to correct the interference by one or more of the following measures:

- Reorient or relocate the receiving antenna.
- Increase the separation between the equipment and receiver.
- Connect the equipment to an outlet on a circuit different from that to which the receiver is connected.
- Consult the dealer or an experienced radio/TV technician for help.
- Changes or modifications not expressly approved by Brother Industries, Ltd. could void the user's authority to operate the equipment.

GENERAL PRECAUTIONS

- Use only Brother TZe tapes with this machine. Do not use tapes that do not have the mark.
- Do not pull on the tape being fed from the P-touch, otherwise the tape cassette may be damaged.
- Do not attempt to cut the tape while printing or feeding since this will damage the tape.
- Do not clean the machine with alcohol or other organic solvents. Only use a soft, dry cloth.
- Remove the batteries and disconnect the AC adapter if you do not intend to use the machine for an extended period of time.
- Note:** If power is disconnected for more than three minutes, all text shown in the display and any text files stored in the memory will be lost. Language and unit settings will also be cleared.
- Do not put any foreign objects into or heavy objects on the machine.
- Do not expose the machine to extremely high temperatures or high humidity. Never leave it on the dashboard or in the back of your car.
- Avoid using the machine in extremely dusty places. Keep it out of both direct sunlight and rain.
- Do not leave any rubber or vinyl on the machine for an extended period of time, otherwise the machine may be stained.
- Do not touch the print head mechanism. If the head is touched, clean it immediately with a soft wipe (e.g. a cotton swab) to avoid permanent damage.
- To avoid injuries, do not touch the cutter's edge.
- Use only the AC adapter designed exclusively for this machine. Use of any other adapter may void the warranty.

SPECIFICATIONS

Dimensions: 4.32" (W) X 7.84" (D) X 2.21" (H)
(108mm (W) X 196mm (D) X 55mm (H))
Weight: 0.74 lbs. (335g) (without batteries and tape cassette)
Power supply: Six AAA size alkaline batteries or optional AC adapter (model AD-30)
Tape cassette: Brother TZe tape
1/4" / 3/8" / 1/2" (width) (6mm, 9mm, 12mm (width))
Cutter unit: TC-5 (replacement)

POWER SUPPLY & TAPE CASSETTES

- Remove the back cover by pressing in the rough area at the top end of the machine and then flip away from the machine. If a tape cassette is already installed, remove it by pulling it straight up. Also, if batteries are already installed, remove them.
- Insert the batteries into the battery compartment with the positive end of the bottom three batteries pointing away from the cutter lever, and the positive end of the top three batteries pointing toward the tape cutter lever. Always replace all six batteries at the same time using brand new ones.
- Insert a tape cassette, making sure that it snaps into place.
 - Make sure that the end of the tape feeds under the tape guides.
 - Be sure to remove the paper tab when installing a new tape cassette.
 - If the ink ribbon is loose, use your finger to wind the toothed wheel in the direction of the arrow on the cassette.
 - Use only Brother TZe tapes with this machine.

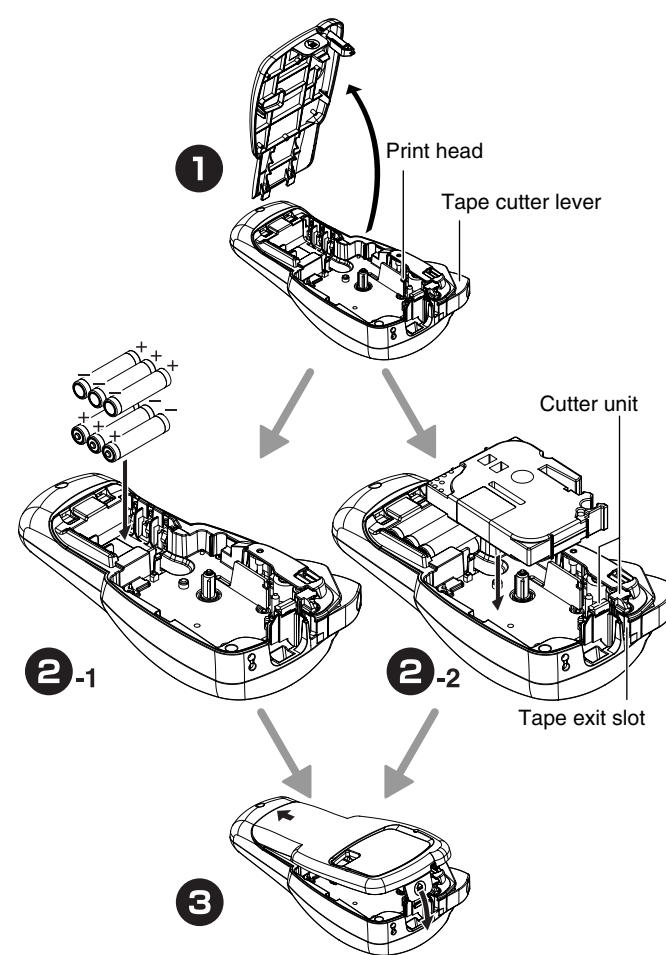
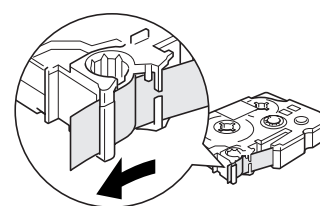

Optional AC adapter (model AD-30)

- Insert the plug on the adapter cord into the adapter jack on the bottom end of the machine.
- Plug the other end of the adapter to the nearest standard electrical outlet.

Cutter unit (replacement)

If the cutter blade becomes blunt after repetitive use and the tape cannot be cut cleanly, replace with new cutter unit (stock no. TC-5) by obtaining from an authorized brother dealer.

KEYBOARD & LCD

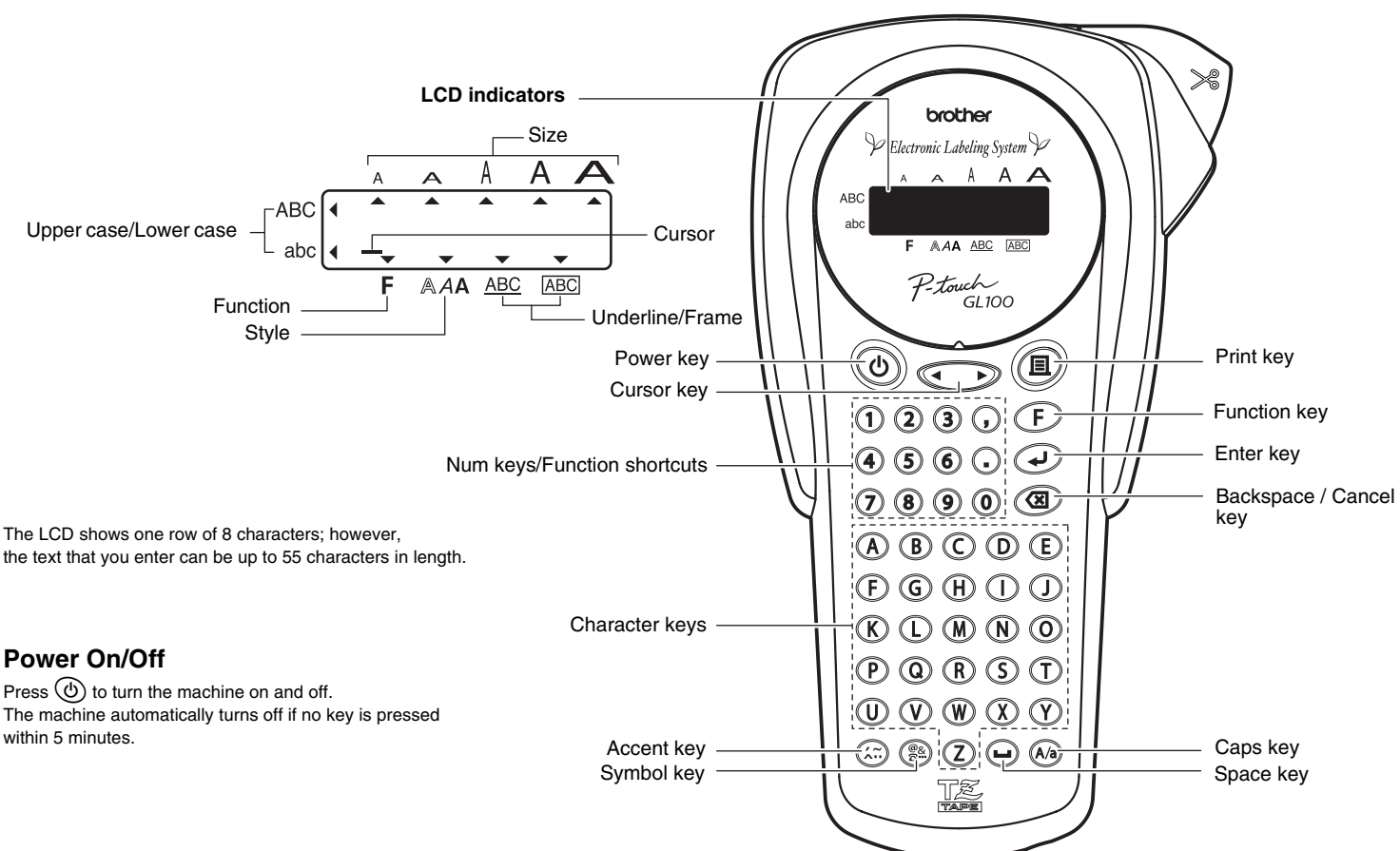

The LCD shows one row of 8 characters; however, the text that you enter can be up to 55 characters in length.

Power On/Off

Press to turn the machine on and off. The machine automatically turns off if no key is pressed within 5 minutes.

GETTING STARTED

- Start your machine**
Supply power by using six AAA batteries or the optional AC adapter, and then press .
- Set the language (English/French/German)**
1. ENG? →
Choose a language with and press .
ENGLISH FRANÇAIS DEUTSCH
Check the display and press . (To cancel, press .)
- Set the unit (mm/inch)**
1. mm? →
Choose a unit with and press .
mm inch
Check the display and press . (To cancel, press .)

NOTE: You can also display the languages and units by pressing the corresponding Num keys (1-3).

- NOTE:**
- To cancel operations, press .
 - To delete entries backward, press .
 - To initialize the settings, turn off the machine and then while holding down and , press to turn the machine back on. Finally, release and .

MAKING TEXT

Switching UPPER CASE/LOWER CASE

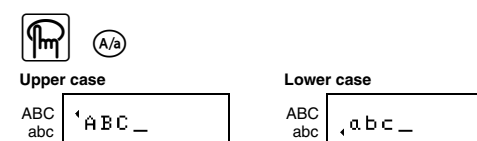

Making A TWO LINE LABEL

Move the cursor to where the second line starts and press .
NOTE: Use either 9 mm or 12 mm wide tape for two line labels.

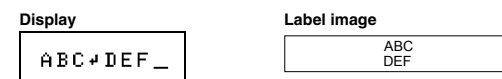

Entering SYMBOLS

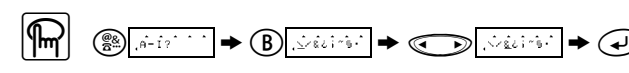

Group	Symbols	Group	Symbols
A	? ! " ' : ; - _	F	→ ← ↑ ↓ ↻ ↺
B	\ / & ^ ~ ` \$ %	G	* \$ £ € ¢ ₣ f i j
C	@ # % & * ^	H	! @ # \$ % ^ & * ^
D	+ - x * ± ÷ ÷	I	☎ ★
E	() [] < >		

- NOTE:**
- You can also display the symbols by pressing / .
 - To go to the next group, press .
 - To skip to a different group, press the corresponding character key of the group.
 - You can also scroll the symbols in each group by pressing the corresponding character key of the group repeatedly.

Entering ACCENTED CHARACTERS



Letter	Accented characters	Letter	Accented characters
A	Á Â Ã Ä Å Æ	a	á â ã ä å æ
C	Č Ć Ć	c	č ć Ć
D	Đ Đ	d	đ đ
E	É Ê Ë Ì Í Î	e	é ê ë ì í î
I	İ İ İ İ İ	i	ı ı ı ı ı
L	Ł Ł Ł	l	ł ł ł
N	Ñ Ñ Ñ	n	ñ ñ ñ
O	Ó Ô Õ Ö Ø	o	ó ô õ ö ø
R	Ř Ř	r	ř ř
S	Š Š	s	š š
T	Ť Ť	t	ť ť
U	Ú Ú Ú Ú Ú	u	ú ú ú ú ú
Y	Ÿ Ÿ	y	ÿ ÿ
Z	Ž Ž Ž	z	ž ž ž

- NOTE:**
- You can also display the characters by pressing / .
 - To go to the next letter group, press .
 - To skip to a different letter group, press the corresponding character key.
 - You can also scroll the characters in each letter group by pressing the corresponding character key repeatedly.

DESIGNING LABELS

Setting FONT (F+1)

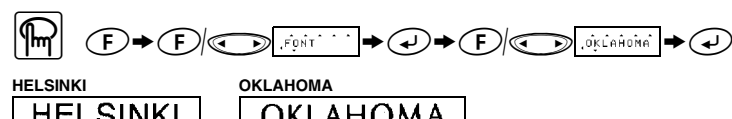

Setting SIZE (F+2)

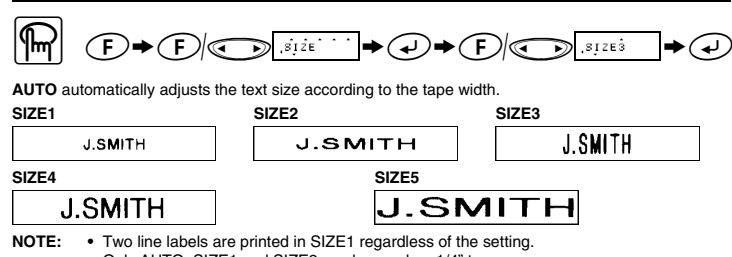

Setting STYLE (F+3)

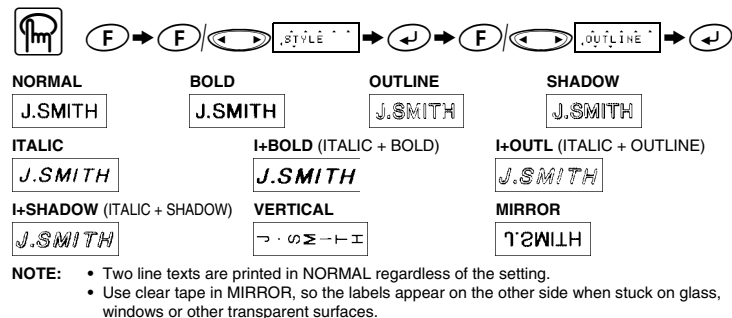

NOTE: Two line labels are printed in NORMAL regardless of the setting. Use clear tape in MIRROR, so the labels appear on the other side when stuck on glass, windows or other transparent surfaces.

Setting UNDERLINE/FRAME (F+4)

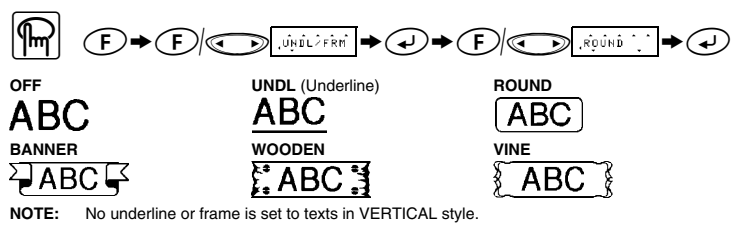

Setting TAB (F+5)

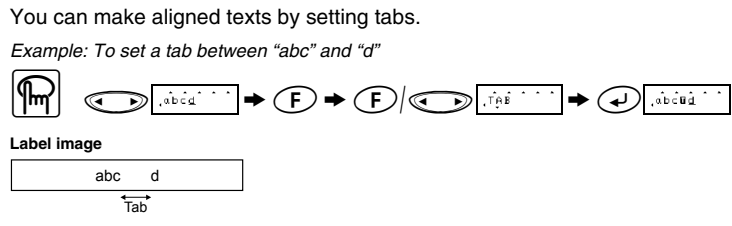

Setting TAB LENGTH (0.0" - 4.0") (F+6)

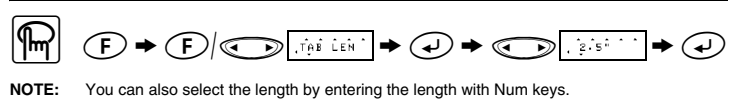

Setting LABEL LENGTH (AUTO/1.6" - 11.8") (F+7)

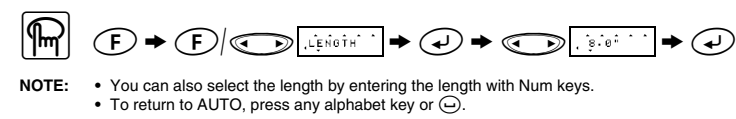

NOTE: You can also select the length by entering the length with Num keys. To return to AUTO, press any alphabet key or .

Using AUTO FORMAT (F+8)

You can choose label length from six formats to create labels for various applications.

LCD	Application	Length	Application	Length
VCR VHS	VCR VHS	5.5"	FILE TAB	File Tab
FD 3.5"	3.5" Floppy Disk	2.7"	AUDIO 8	Audio Cassette
CD CASE	CD	3.9"	VIDEO 8	VCR 8mm (Video 8)

To CLEAR (F+0)

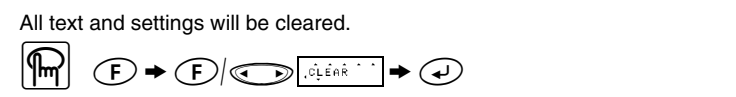

NOTE: Included with your GL-100 garden labeler is our "standard TZe" laminated tape. You will find that this tape is perfectly suited for almost all of your indoor and outdoor labeling needs.

For your more difficult labeling needs, we recommend that you try our "Extra Strength Adhesive" TZe laminated tapes. This adhesive is up to twice as strong as what you will find on our standard TZe tapes. This enhanced adhesive enables you to use these tapes on difficult surfaces such as wood, painted metal and textured plastics. If your labeling job involves particularly harsh environments or difficult to stick surfaces, please try our "Extra Strength Adhesive" TZe laminated tapes.

PRINTING

TEXT PREVIEW (F+⊞)

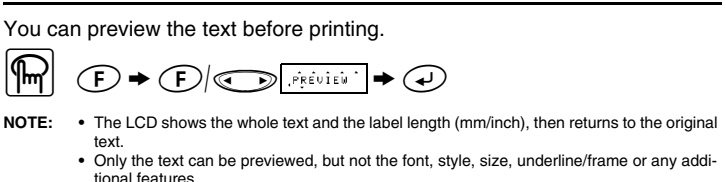

FEEDING (TAPE FEED) (F+⊞)



PRINTING



NOTE: To cut off the label, push in the tape cutter lever on the upper-right corner of the machine. To prevent damage to the tape, do not try to cut while the message PRINT or FEED is displayed.

TAPE MARGIN (F+⊞)

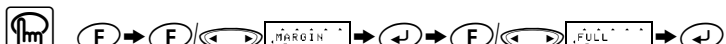

NOTE: Cut along the printed dots (•) with scissors so the text is centered in the label.

CHAIN is for printing more than 1 copy of a label with minimum margin <e.g. 1>. You can also create a label containing texts in various styles; print a text in one style, and before feeding, enter the second text in another style <e.g. 2>.

NOTE: FEED THE TAPE BEFORE USING THE CUTTER (see FEEDING/PRINTING). Otherwise A PART OF THE TEXT MAY BE CUT OFF. Do not try to pull the tape since this may damage the tape cassette.

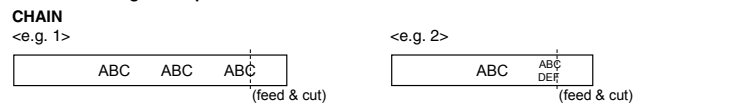

Print Option/REPEAT PRINTING (F+⊞)

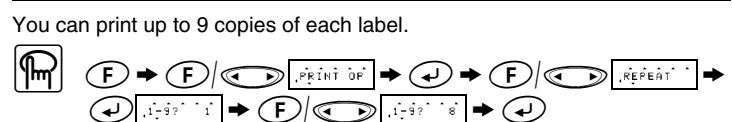

NOTE: When the tape margin is set to CHAIN, FEED THE TAPE BEFORE USING THE CUTTER (see FEEDING/PRINTING). Otherwise A PART OF THE TEXT MAY BE CUT OFF. Do not try to pull the tape since this may damage the tape cassette.

Print Option/NUMBERING (F+⊞)

You can print many copies of the same text while increasing a selected number by 1 after each label is printed.

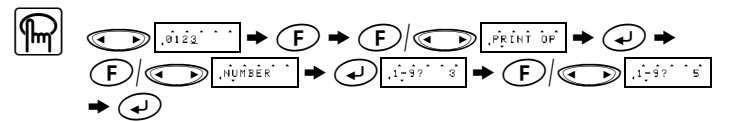

NOTE: The last number that will be printed must be larger than the number selected in the text, otherwise the message ERROR appears. When the tape margin is set to CHAIN, FEED THE TAPE BEFORE USING THE CUTTER (see FEEDING/PRINTING). Otherwise A PART OF THE TEXT MAY BE CUT OFF. Do not try to pull the tape since this may damage the tape cassette.

MEMORY (F+9)

You can store up to 9 frequently used text files and recall them to create labels more quickly and easily. (Total memory size: about 300 characters.)



To STORE:

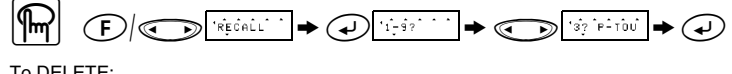

To RECALL:

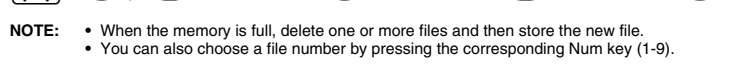

To DELETE:

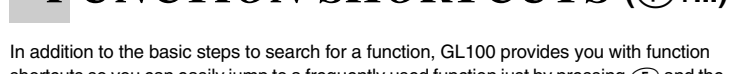

FUNCTION SHORTCUTS (F+...)

In addition to the basic steps to search for a function, GL100 provides you with function shortcuts so you can easily jump to a frequently used function just by pressing and the shortcut key shown in the table below. To confirm, press (or the shortcut key again).

Key	LCD message	Function	Key	LCD message	Function
⊞	FONT	Character font	⊞	A/F	Auto Format
⊞	SIZE	Character size	⊞	MEMORY	Memory
⊞	STYLE	Print style	⊞	CLEAR	Clear text + style
⊞	UNDL/FRM	Underline/Frame	⊞	MARGIN	Tape margin
⊞	TAB	Tab setting	⊞	PRINT OP	Repeat/Numbering
⊞	TAB LEN	Tab length	⊞	PREVIEW	Text preview
⊞	LENGTH	Label length	⊞	FEED	Tape feed

NOTE: PRINT OP contains two functions, REPEAT PRINTING and NUMBERING. For PREVIEW and FEED, press to preview/feed after the LCD message appears.

NOTE: You can also refer to the chart indicated on the back of the machine.

ERROR MESSAGE LIST

ERROR	Solution
BATTERY	An error occurred.
BATTERY	The batteries are weak.
BATTERY	The batteries are empty.
FULL	The maximum number of characters (55 characters) have already been entered or the memory is full.
LONG TXT	The text length exceeds the selected label length.

TROUBLESHOOTING

Problem	Solution
The display stays blank after you have turned on the machine.	<ul style="list-style-type: none"> Check that the batteries are correctly inserted. If the batteries are weak, replace them. Check that the adapter is correctly connected.
The machine does not print, or the printed characters are blurred.	<ul style="list-style-type: none"> Check that the tape cassette has been inserted correctly. If the tape cassette is empty, replace it. Check that the character size is appropriate for the width of the tape that is used.
The printed characters are not formed properly.	<ul style="list-style-type: none"> If the batteries are weak, replace them.
Striped tape appears.	<ul style="list-style-type: none"> The tape cassette is empty. Replace it.
The memory has cleared on its own.	<ul style="list-style-type: none"> The batteries may be weak. Replace them.
A blank horizontal line appears through the printed label.	<ul style="list-style-type: none"> There may be some dust on the print head. Remove the tape cassette and use a dry cotton swab to gently wipe the print head with an up-and-down motion.
The machine has "locked up" (i.e., nothing happens when a key is pressed, even though the machine is on).	<ul style="list-style-type: none"> Turn off the machine, and then while holding down and , press to turn the machine back on. Finally, release and . Note: The text and formats in the display and all text files stored in the memory are erased. Also, the language and unit settings will be cleared.