

brother®

# P-TOUCH 30/35

USER'S GUIDE

## **YOUR P-TOUCH**

Thank you for purchasing the P-TOUCH labeling system!

Your new P-TOUCH will help you design and print labels for any application. Extremely versatile, it can create characters in many sizes and styles. In addition, by using the variety of tape cartridges available, you can print labels with different widths and exciting colors.

You no longer have to worry about rushing tasks that require professional-type printing. In the office, the factory, the lab and the home, the quality and performance of the P-TOUCH make it a very versatile machine.

Finally, as we expect you will want to refer to this manual occasionally, we suggest that you keep it in a handy place.

### **FCC NOTICE**

This equipment has been tested and found to comply with the limits for a Class B digital device, pursuant to Part 15 of the FCC Rules. These limits are designed to provide reasonable protection against harmful interference in a residential installation. This equipment generates, uses, and can radiate radio frequency energy and, if not installed and used in accordance with the instructions, may cause harmful interference to radio communications. However, there is no guarantee that interference will not occur in a particular installation. If this equipment does cause harmful interference to radio or television reception, which can be determined by turning the equipment off and on, the user is encouraged to try to correct the interference by one or more of the following measures:

Reorient or relocate the receiving antenna.

Increase the separation between the equipment and receiver.

Connect the equipment into an outlet on a circuit different from that to which the receiver is connected.

Consult the dealer or an experienced radio/TV technician for help.

Changes or modifications not expressly approved by Brother Industries, Ltd. could void the user's authority to operate the equipment.

### **This product is covered by one or more of the following patents.**

USP4839742	USP4983058	EP315369	GB2223740
USP4922063	USP5009530	EP322918	
USP4927278	USP5069557	EP322919	
USP4966476	USP5120147		
USP4976558			

# CONTENTS

## YOUR P-TOUCH

CONTENTS .....	i
----------------	---

ABOUT THIS MANUAL .....	1
-------------------------	---

## BEFORE YOU START

MACHINE DIAGRAM .....	4
GENERAL PRECAUTIONS .....	6
TAPE CASSETTES .....	7
CLEANING THE PRINT HEAD .....	8
INSERTING BATTERIES .....	9
OPTIONAL AC ADAPTOR .....	10

## LEARNING THE ROPES

INTRODUCTION (Learning the ropes) .....	12
DOOR SIGN EXAMPLE .....	13
RENTAL BIKE IDENTIFICATION LABEL .....	17
STORAGE SHELF LABEL EXAMPLE .....	23

## FOR YOUR INFORMATION

INTRODUCTION (For your information) .....	32
FINDING YOUR WAY .....	33
ON/OFF KEY .....	34
THE CURSOR .....	35
SHIFT, ALT, & CAPS .....	36
THE CODE KEY .....	37
SYMBOLS .....	38
COMPOSITE CHARACTERS .....	39
RETURN .....	40
NEW BLOCK .....	42
SEQUENTIAL NUMBERING .....	43
CANCEL .....	46
CURSOR MOVEMENT .....	47
ENTERING TEXT .....	48
BACKSPACE .....	49

LINE OUT .....	50
CLEAR .....	51
BASIC FORMATTING PRINCIPLES .....	52
FONT .....	54
SIZE .....	55
WIDTH .....	56
STYLE .....	58
UNDERLINE .....	60
FRAMING .....	61
LENGTH .....	62
HORIZONTAL ALIGNMENT .....	63
VERTICAL ALIGNMENT .....	64
VERTICAL PRINTING .....	65
MIRROR PRINTING .....	67
GLOBAL FORMATS .....	68
LOCAL FORMATS .....	70
STORE .....	72
RECALL .....	73
M. DELETE .....	75
PRINTING & TAPE FEED .....	77
BAR CODING .....	80
USING THE TAPE SEPARATOR/LETTERING STICK .....	85
<b>MESSAGE LIST .....</b>	<b>86</b>
<b>TROUBLESHOOTING .....</b>	<b>91</b>
<b>MACHINE SPECIFICATIONS .....</b>	<b>92</b>
<b>FEATURES .....</b>	<b>93</b>
<b>INDEX .....</b>	<b>94</b>

## **ABOUT THIS MANUAL**

Although the P-TOUCH is easy to use, we suggest that you read this manual carefully before starting. The manual consists of three main sections:

- |                             |   |
|-----------------------------|---|
| <b>BEFORE YOU START</b>     | Provides basic information concerning the machine itself, tape cartridges and power supplies.                                       |
| <b>LEARNING THE ROPES</b>   | This tutorial section leads you through easy-to-follow practice sessions designed to familiarize you with the machine's operations. |
| <b>FOR YOUR INFORMATION</b> | A handy reference section with detailed explanations of all of the P-TOUCH's features.  |

You should read the brief "Before you start" section before using your P-TOUCH. If this is your first time using this machine, or if you would like to brush up on some of the techniques used, we suggest that you work through the exercises in "Learning the ropes". If you have more detailed questions about specific features, the "For your information" section will provide the answers.

Have fun! We hope you enjoy using your P-TOUCH.



***Before you  
start***

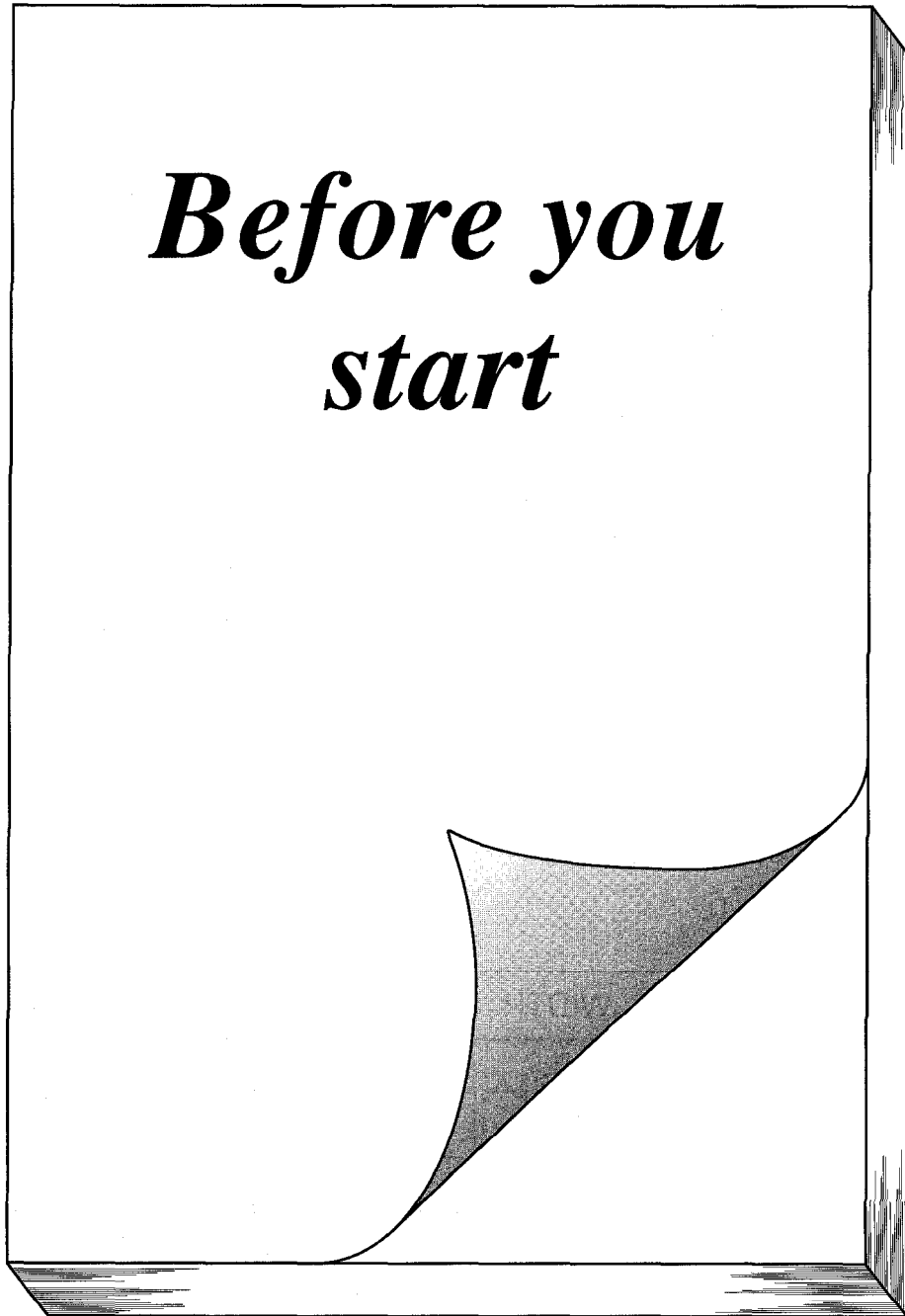

# MACHINE DIAGRAM

## KEYBOARD

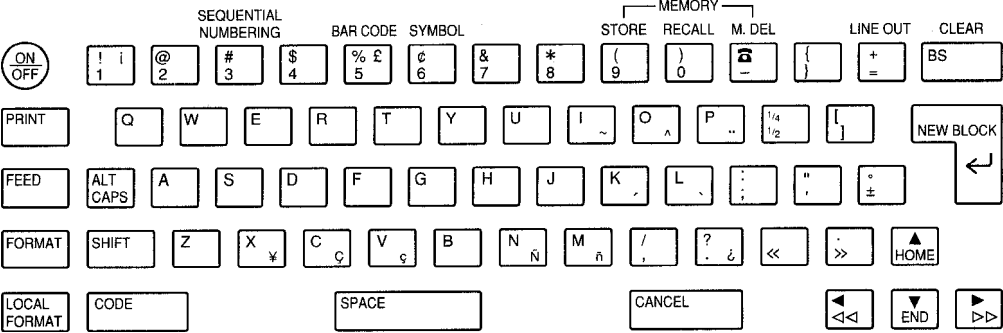
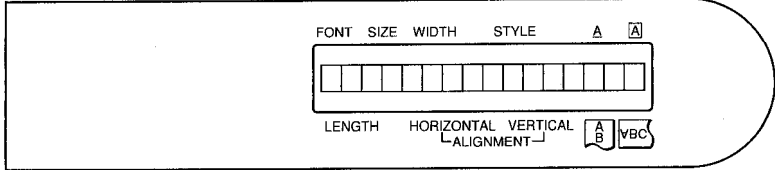

## LCD DISPLAY

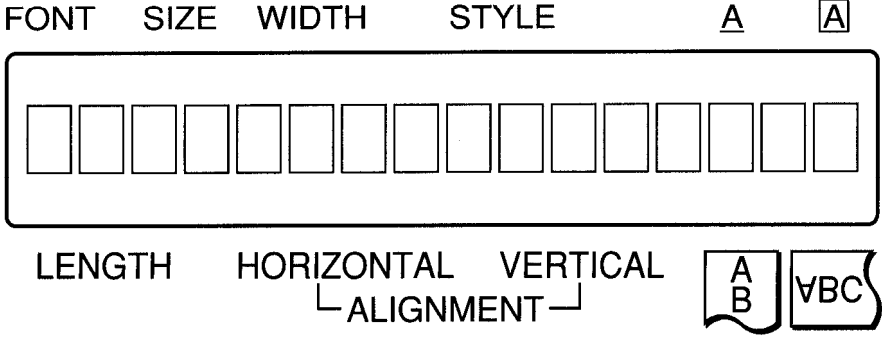



# FEATURES

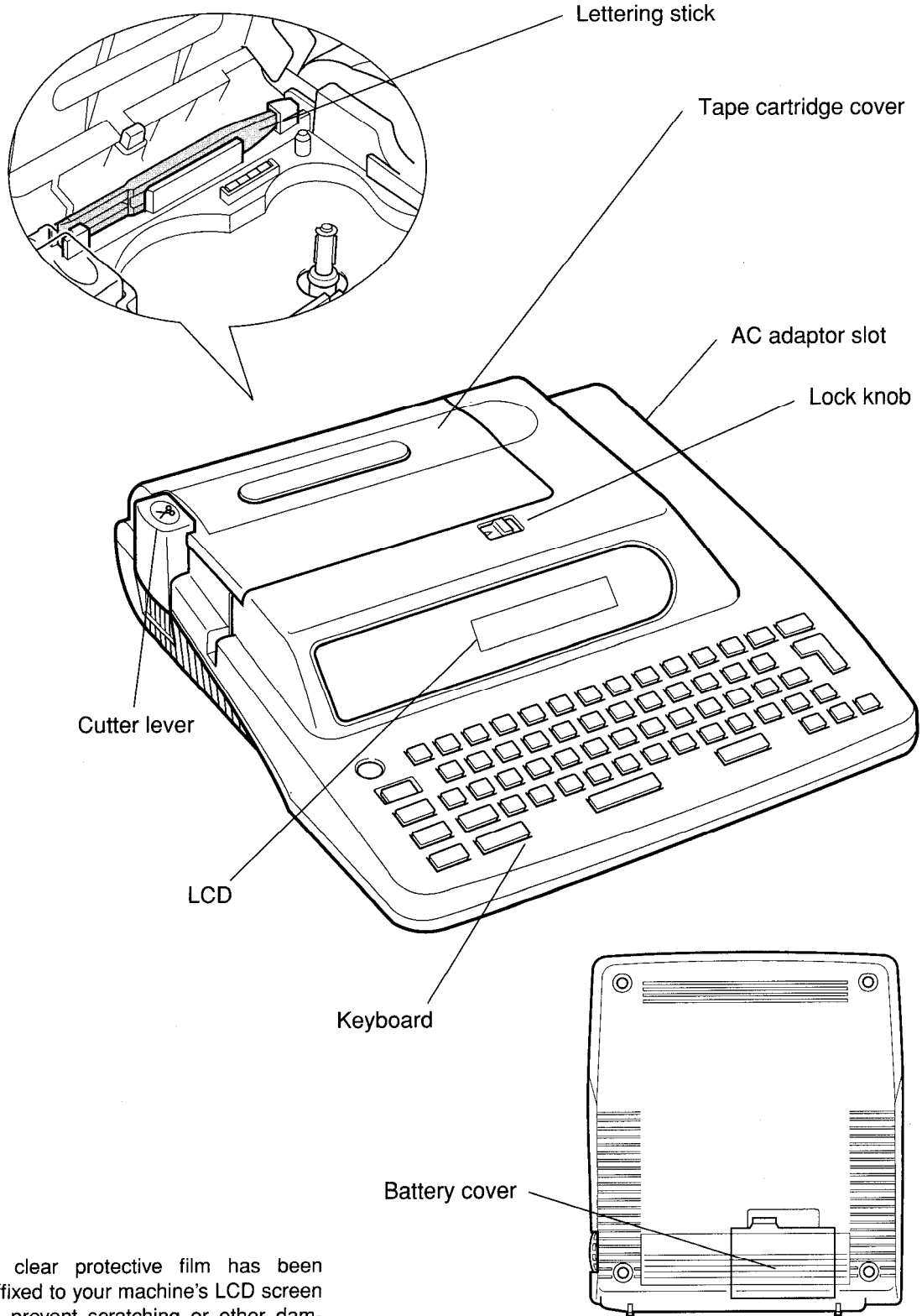

A clear protective film has been affixed to your machine's LCD screen to prevent scratching or other damage during transport. Please remove it for clearer readability.

## GENERAL PRECAUTIONS

- Do not pull on the tape. This may damage the tape cassettes.
- Do not clean the machine with alcohol or other organic solvents. Only use a soft, dry cloth.
- To avoid injuries, do not touch the cutter's edge.
- Do not put any foreign objects onto or into the machine.
- Avoid using the machine in extremely dusty places. Keep it out of both direct sunlight and rain.
- Do not leave any rubber or vinyl on the machine for an extended period of time. Doing so may cause staining.
- Do not expose the machine to high temperatures or high humidity. Never leave it on the dashboard or in the back of your car.
- Only use the AC Adaptor designed exclusively for the P-TOUCH. (AD-8000)
- Remove the batteries and/or disconnect the AC adaptor if you do not intend to use your machine for an extended period of time.
  - ☞ *When power is disconnected, any messages in the working area or the Message Memory Area will be lost.*
- If the ambient temperature is high, try to ensure that the DENSITY is not set to "+1" or "+2"; this may cause the ribbon inside the cassette to tear during printing.

## TAPE CASSETTES

A single tape cassette is supplied with this unit. However, tapes for the P-TOUCH are available in a wide range of background colors, type colors and tape sizes. We encourage you to use this variety of labels for color-coding and other applications where it is useful to create visually distinctive labels.

With this in mind, we have designed the P-TOUCH to allow quick and easy insertion and changing of tape cassettes.

### TO INSERT A TAPE CASSETTE

- (1) Slide the cassette cover lock knob to the right to release the cover. Lift the cover so that you can reach the tape cassette easily. This will also release any installed cassette.
- (2) If there is a tape cassette already in the compartment, remove it by pulling it straight up.
- (3) Remove the stopper from a new tape cassette. If the tape inside the cassette is loose, use your finger to wind it one full turn in the direction of the arrow on the plastic tape cassette.
- (4) Insert the tape cassette firmly into the compartment.
- (5) Shut the compartment cover.
- (6) Press the FEED key once and cut the tape to remove any slack from the tape.

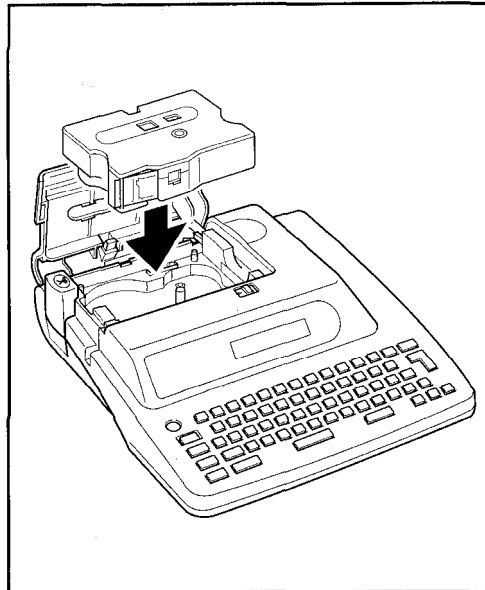
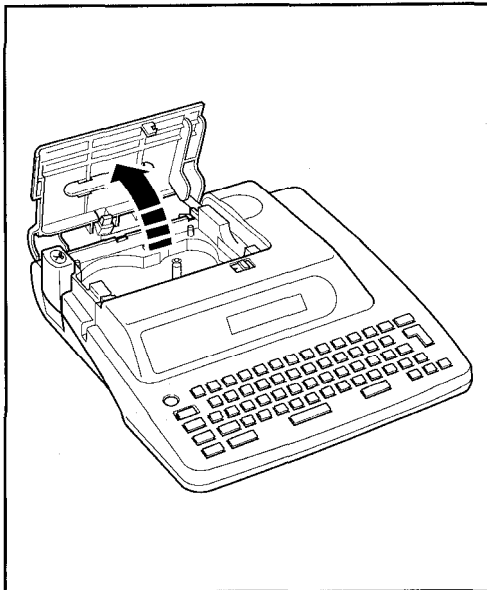

## CLEANING THE PRINT HEAD

Occasionally, specks of dust or dirt may attach themselves to the machine's print head. This is particularly likely when the unit is used outdoors or in very dusty environments. When this occurs, the print element obscured by the dust cannot print, causing an unprinted (blank) line to stretch across the label.

Therefore, like the head of a tape recorder, this machine's head may need cleaning from time to time.

### HOW TO CLEAN THE PRINT HEAD COLUMN

- (1) Turn off the machine.
- (2) Open the cassette compartment cover and remove the tape cassette.
- (3) Wipe the print head gently with a dry cotton swab in the up-down direction. Try a test print again.

If dust still remains:

- (4) Dip the cotton swab in isopropyl (rubbing) alcohol and repeat step (3).

If none of the above works, contact your service representative.

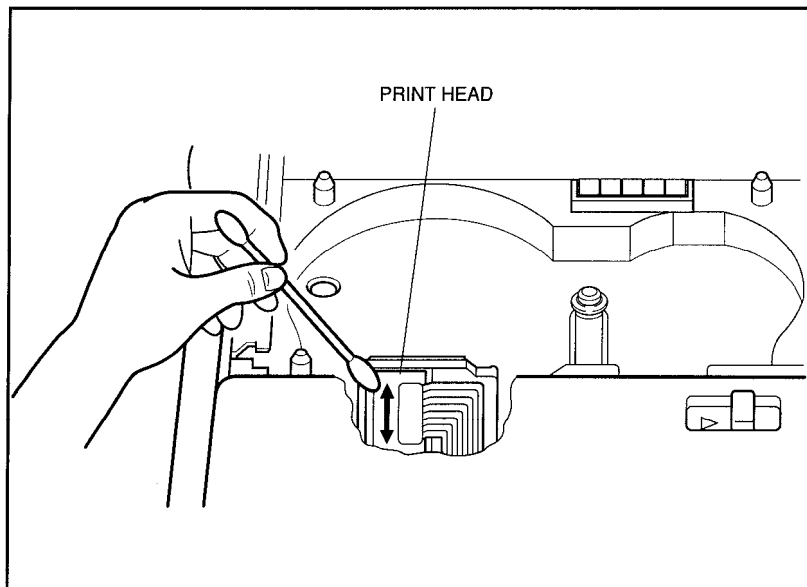

 Do not touch the print head mechanism with your fingers. If the head is touched, clean it immediately with a soft wipe (e.g. a cotton swab) to avoid permanent damage.

## INSERTING BATTERIES

The P-TOUCH takes six size 'C' batteries. Preferably, you should use alkaline batteries. When you change the batteries, always replace all six at the same time.

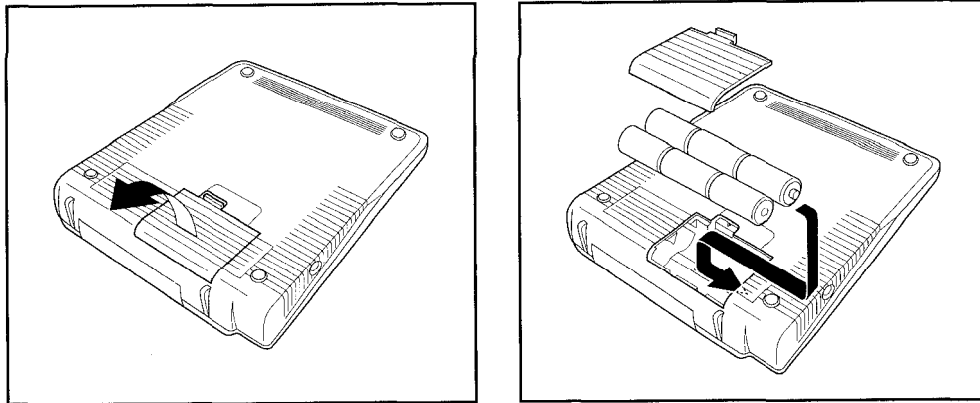

-  *Make sure that you insert the new batteries within five minutes of removing the old batteries; otherwise, the message in the working area and any messages stored in the Phrase Memory will be lost (unless the P-TOUCH is plugged into an AC adaptor).*

### **IMPORTANT NOTE CONCERNING BATTERY OPERATION!**

Your P-TOUCH is capable of printing large, eye-catching characters in a variety of formats. However, doing so regularly -- particularly on wide tape -- can be a severe strain on batteries. Therefore, to prevent premature weakening of your batteries, an optional AC adaptor is recommended for printing large fonts, bar codes and symbols in volume on 18mm and 24mm tape.

## OPTIONAL AC ADAPTOR

The P-TOUCH is a lightweight, portable machine. The optional AC adaptor (AD-8000) allows you to use the machine anywhere that a standard electrical outlet is available.

### TO ATTACH THE AC ADAPTOR

- (1) Insert the adaptor's small connector into the attachment slot on the right side of the machine.
- (2) Plug the large connector into the nearest standard electrical outlet.

 *Only use the AC adaptor designed exclusively for the P-TOUCH.*

*Remove the batteries and/or disconnect the AC adaptor if you do not intend to use your machine for an extended period of time.*

*When power is disconnected, any messages in the working area or the Message Memory Area will be lost.*

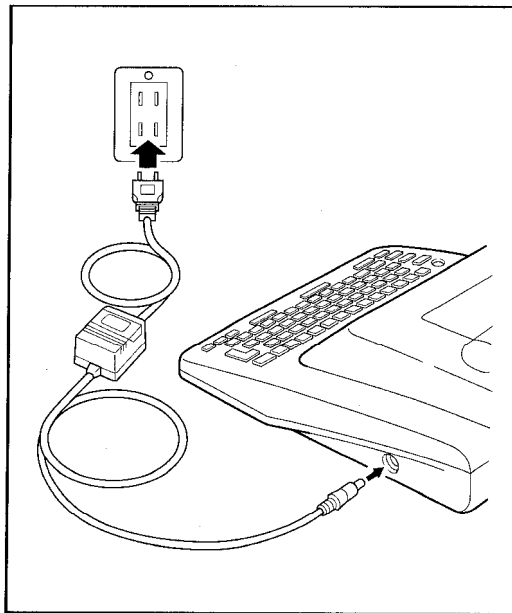

*Learning  
the ropes*

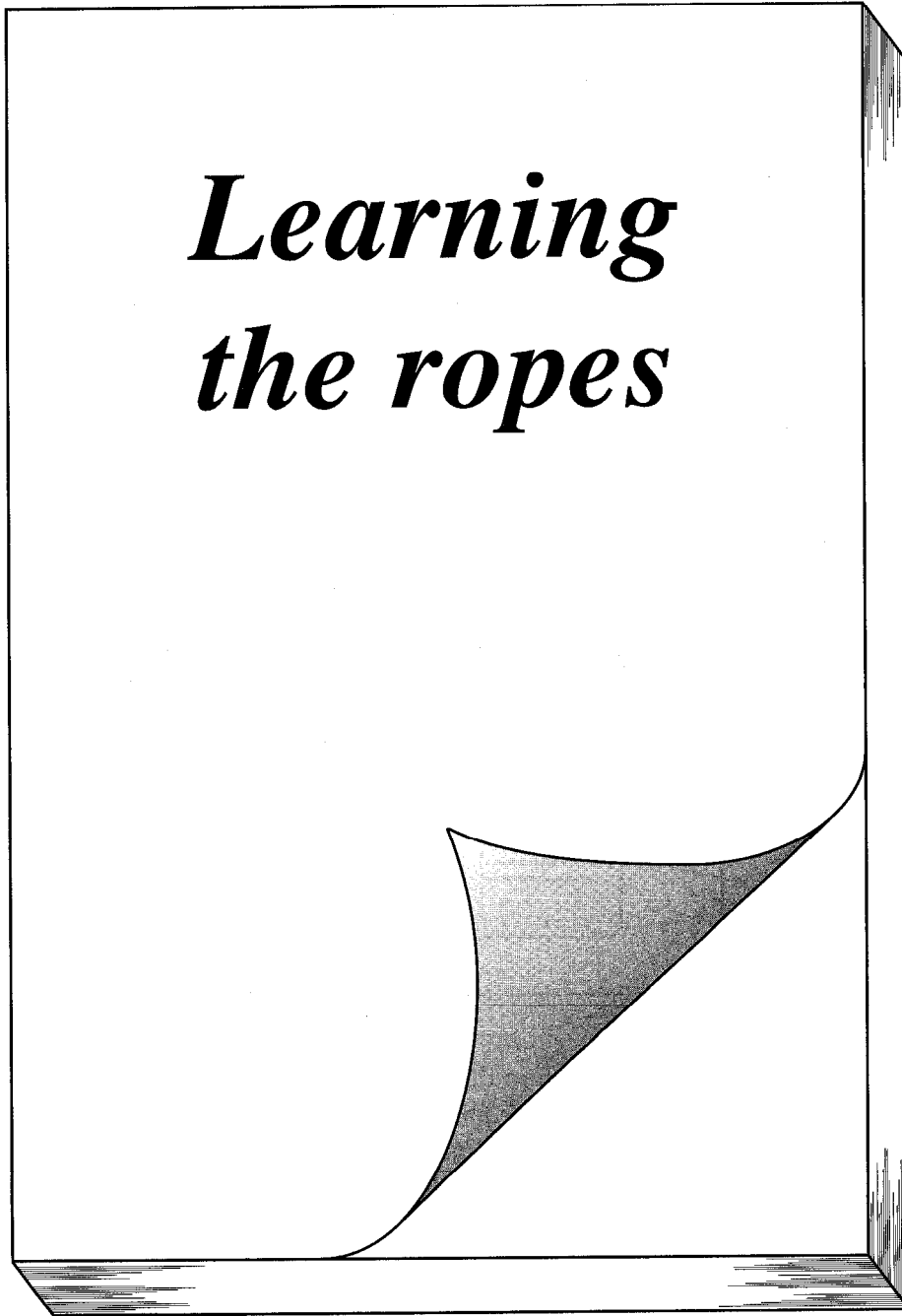

# INTRODUCTION (*Learning the ropes*)

In "Learning the ropes" you will find a series of label-making examples. These examples will help you start making labels immediately, before reading the detailed "For your information" section. The featured label designs become increasingly complex, requiring you to use the more advanced features of the P-TOUCH. The first exercise consists of creating a simple, one-line door sign. The second, an identification label, takes advantage of several additional machine capabilities. Finally, the storage shelf label shows you how to use the unit's expert features.

If you are a first-time user, we suggest that you work through these exercises, following all the instructions on your machine. The exercises do not take much time; they can either be done all at once, or in three separate working sessions.

The "Learning the ropes" practice sessions consist of the following parts:

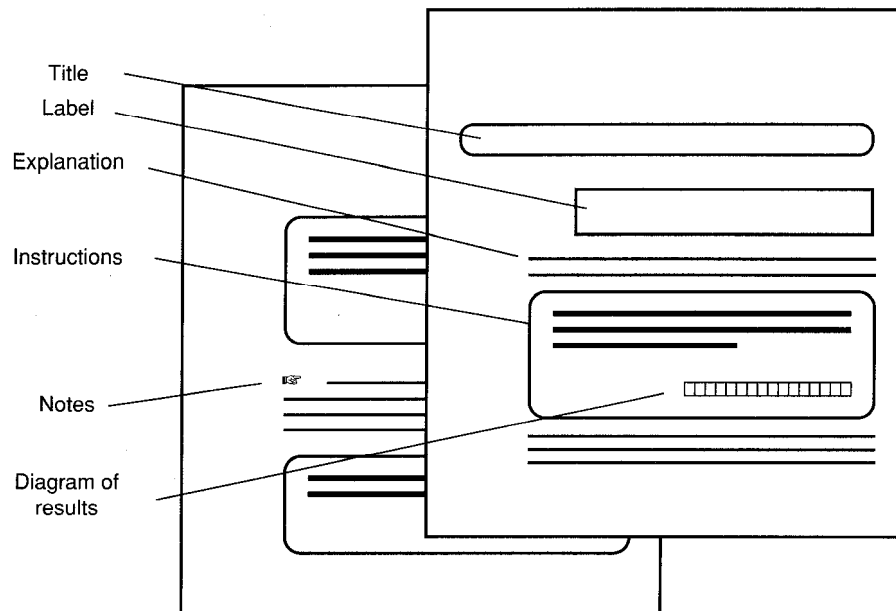

To use this training section in the most effective way, simply follow the flow of the practice sessions. Read the background explanations, then repeat the instructions on your P-TOUCH, checking that your results match the diagrams provided here in the manual. If you would like more detailed information about a particular point, you can look it up in the "For your information" section. And remember, if you ever get lost, or want to reinforce a point you have learned, you can easily start again or repeat any of the practice examples in "Learning the ropes".

And now, let's see how easy it is to make beautiful labels with the P-TOUCH!



# Step 1

## DOOR SIGN EXAMPLE



First, you must turn on the machine's power. The On/Off key is located on the upper left-hand side of the keyboard.

**To turn on the P-TOUCH:**

- Press  .



1 : |\_|\_|\_|\_|\_|\_|\_|\_|\_|\_|\_|\_|\_|\_|\_|\_|

The display will show each line of text that you input. The "1:" on the left indicates that this is the first line of the message. Although the machine's LCD display is 16 characters wide, you can create messages with many more characters. The 16-character display is like a window which moves across your message, allowing you to view different parts.

The mark resembling an underline is called a "cursor". The cursor is like a pointer which shows your current position, and lets you select individual characters or portions of your text.

Now we wish to enter the word "Conference". To do so, we must first input a capital "C".

**To input a capital C:**



- Hold down  and press .

1 : C \_ \_ \_ \_ \_ \_ \_ \_ \_ \_ \_ \_ \_ \_

- Release  and type "onference".

1 : C o n f e r e n c e \_ \_ \_ \_

As on a typewriter, the **SPACE** key lets you put a blank space in a message.

 *The **SPACE** key and  key have different functions. The  key moves the cursor forward through inputted text without adding blank spaces.*

**To complete the message "Conference Room":**

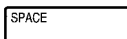
- Press  once to add a blank space.

1 : C o n f e r e n c e \_ \_ \_

Next, enter the word "Room":

- Hold down  and press .

- Release  and type "oom".

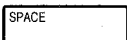

- Press  once to add another blank space.

 *The line of text is longer than the LCD display. The first characters, "Con", will move off the display.*



1 : f e r e n c e R o o m \_

Next, suppose that we wish to add a “No Smoking” symbol to our door sign. The “No Smoking” mark is just one of many available on the P-TOUCH. A detailed explanation of symbol entry can be found in the section entitled “Symbols” in “For your information” (page 38).

**To add a “No Smoking” symbol to the end of the message:**

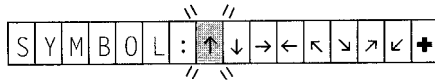
- Press  +  . The first group of symbols will be displayed.



- Press  and  to scroll through the available symbol groups until the group with the “No Smoking” symbol is displayed.

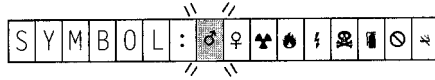

- Press  until the “No Smoking” symbol is selected (a symbol blinks when it is selected).

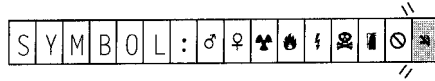

- Press  . The “No Smoking” symbol will be added to your message.

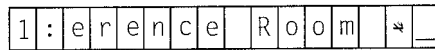

Once you have created a message, the P-TOUCH allows you to edit it easily, to correct mistakes or change the text or style. Detailed explanations of text editing methods can be found on pages 47 to 51 in “For your information”.

Now, let's practice editing by inserting the room number "203".

On the P-TOUCH, characters are added to the message at the cursor position (for details of character entry, see "Entering text" on page 48 of "For your information").

**To insert the room number, "203", into the message, changing it to "Conference Room 203" (thus completing the message):**

- Press  until the cursor is positioned at the point at which you want to insert the character.



l : e r e n c e R o o m |

- Enter "203" and add a blank space.

l : n c e R o o m 2 0 3 |

Since our message is finished, we can now print it. Although several printing settings are available, we will use the default settings pre-programmed into the P-TOUCH.

**To print the label:**

- Press  . Print setting options will appear on the display. Press  to print without changing the settings.
- When the label has been printed and the tape has stopped moving, press the cutter lever to cut off the label.

# Step 2

## RENTAL BIKE IDENTIFICATION LABEL

In this label-making session, let's assume that you want to make some identification labels for rental bikes.

<p>Smith's Rent-A-Bike #1 29 Green Road, LA TEL: 345-6789</p>	<p>Smith's Rent-A-Bike #2 29 Green Road, LA TEL: 345-6789</p>
<p>Smith's Rent-A-Bike #3 29 Green Road, LA TEL: 345-6789</p>	<p>Smith's Rent-A-Bike #4 29 Green Road, LA TEL: 345-6789</p>

 This example cannot be printed on 6mm tape.

In this practice session, we will make a multi-line, automatically numbered identification label.

**To prepare for a new label:**

- Turn on the power.
- If the previous work session's text data is still displayed, press  +
- A confirmation message, "OK TO CLEAR?", is displayed. Press  

:



To make multi-line labels, you need to use the **RETURN** key.

The **RETURN** key (  ) operates like the RETURN on a typewriter, moving the cursor to the next line. When you press the **RETURN** key, a ↵ mark will be added to the text line.

**To enter a three-line message:**



- Type the shop's name followed by an identification number for the bike: "Smith's Rent-A-Bike #1".

1 : e n t - A - B i k e # 1 \_

 To input "#", hold down  and press  .

- Press  . The cursor will move to line 2, allowing you to input a second line of text. Note that the numbers on the display's left side are line numbers.

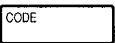

2 : \_ \_ \_ \_ \_ \_ \_ \_ \_ \_ \_ \_ \_ \_

- Press  +  to input a series of capital letters.
- Type the address, "29 GREEN ROAD, LA". All letters will appear as capital letters; there is no need to press  .

2 : R E E N R O A D , L A \_

- Press  .
- To finish the message, type "TEL: 345-6789".

3 : T E L : 3 4 5 - 6 7 8 9 \_



 To input ":", hold down  and press  .

Next, we'll practice using the P-TOUCH's numbering function. This feature is particularly useful for serial numbers and other codes which require sequential numbering. In this example, let's assume that "#1" is the rental bike's identification number - 1. Let's also assume that this number can be used to trace the bicycle in case of theft.

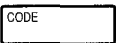

The second bicycle would be numbered #2, the third #3, etc.

When the numbering feature is used, the numbers, letters or bar code included in the field will automatically increase as each label is printed. A detailed explanation of this function can be found in the "Sequential numbering" section in "For your information" (page 43).

**To make "1" a numbering field:**

- Press  + . The cursor will move to the first character of the label.

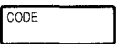
1 : S m i t h ' s R e n t - A

- Press  until the cursor is positioned under the last "1" in the line.
- Press  + . The character will flash.





1 : R e n t - A - B i k e # 1

This is the only character which we want to increase automatically.

- Press .

1 : t - A - B i k e # N I N \_

Any time you wish to view the current format settings, you can press the **FORMAT** key.

Global format settings are shown on two separate screens known as the upper and lower screens. Press the **CODE** key and the  key to switch from the upper screen to the lower, and the **CODE** key and the  key to switch from the lower screen to the upper (alternatively, if the cursor is at either the first or last setting on the current screen, you can simply use the  or  key to switch screens).

The items printed on the case just above the LCD display have their settings displayed on the upper screen, while the items printed below the LCD display have their settings shown on the lower screen. The solid blocks (  ) between the settings indicate whether the currently displayed screen is the upper screen

or the lower screen: if the blocks are in the upper half of the LCD display, the currently displayed screen is the upper screen; if the blocks are in the lower half of the screen, the lower screen is the one currently displayed.

**To view the current format settings:**

- Press **FORMAT** .

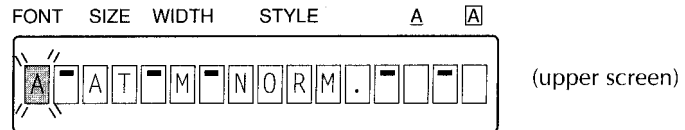

- Press **CODE** + **END** .

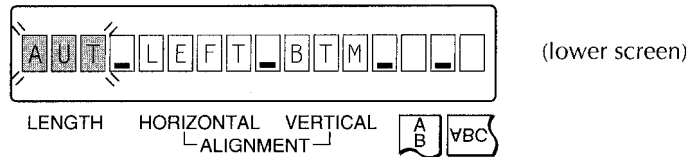

- To return to the upper screen, press **CODE** + **HOME** .

For this label, however, let's assume that we want a different style of text: Font B, framed and horizontally centered. We must therefore create a new format.

**To change to Font B:**

The "A" is flashing. The flashing acts like a cursor; it shows which format setting is currently "active". Items can only be changed when they are active, i.e. when they are flashing.

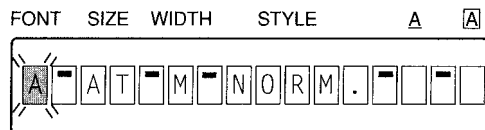

- Press **HOME** or **END** until "B" is displayed.

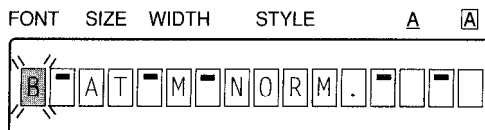



To turn the framing format setting on, proceed as follows:

**To create a frame or box ( □ ):**

- Press  until the framing setting is flashing (it is currently set to off).

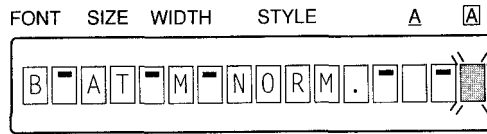

- Press  or  until "□" is displayed.

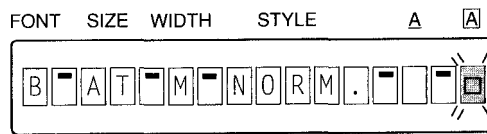



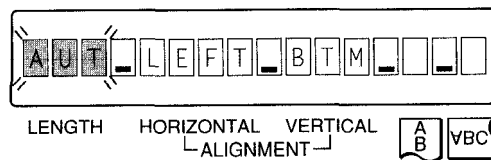

In general, this is the way in which format settings are edited. The ◀ and ▶ keys let you move from item to item. The ▲ and ▼ keys allow you to change the current settings.

**To finish editing the format settings:**

- Press  + .



- Use  and  to move from setting to setting, and  and  to change a setting. Change "HORIZONTAL ALIGNMENT" from Left to Center.

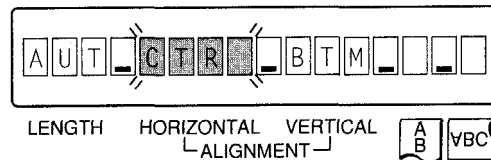

- Press  to enter the selected format settings.

Now let's print the rental bike identification labels which we have just created. In Print setting mode you can specify how many times you want the number to increase. In this example you will make four labels numbered #1 to #4. Hence, you will set "INCREASES" to 4.

**To set the number of steps for the numbering sequence and print out the labels:**

- Press  . The print options menu will be displayed.



- Press  until the "INCREASES" setting, for sequential numbering, is flashing.

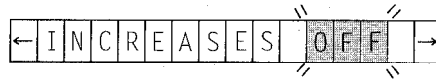

- Press  until the number increases to 4.



- Press  to print a series of sequential numbering labels.

After printing one label, the machine stops. This pause allows you to cut off the tape label. As soon as you have cut it off, the machine automatically prints the next label.

**To print out several labels:**

- The display remains as shown below.

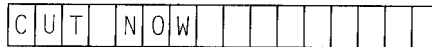

- Cut off a label with the cutter lever and allow printing to continue.

Alternatively, you can print out a whole series of labels on one continuous length of tape. In this case, there is no pause for you to cut off individual labels. Refer to "Printing and tape feed" on page 77 of "For your information" for details.

# Step 3

## STORAGE SHELF LABEL EXAMPLE

In this final practice session we will study the often-used local formatting and multi-block handling features, as well as more specialized features, such as bar coding.

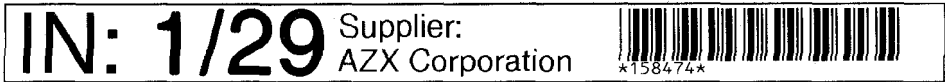

*For this particular example, 6mm wide tape cannot be used.*

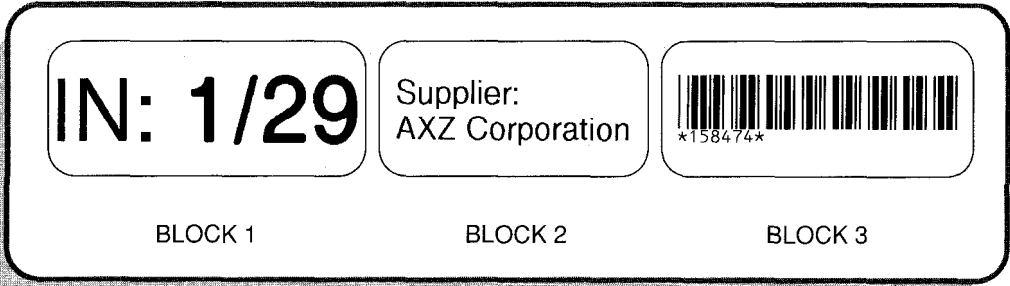

In this session we will make a storage shelf label. Let's assume that you work in a parts warehouse and must make a shelf label which gives information about the parts stocked. This type of complex label – with several blocks of text, local formatting and bar code information – will allow us to practice several of the P-TOUCH's more advanced features. Our final label will appear as shown above.

The label can be considered as having three distinct parts, as shown below. Each part will be entered as a separate "block" (a block is like a paragraph of text in a document). Note that style changes (for example, non-framed to framed, or normal type to bold) require local formatting.

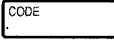

First, we must enter the label's basic text.

**To input the first block of text:**

- Press  +  .



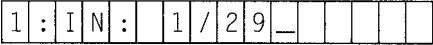

- Type "IN: 1/29".

 *If you have any questions about basic input or editing, please review the previous examples or refer to pages 47 to 51 in "For your information".*





We now want to enter the second, two-line block, so we need to create a new block. To do this, hold down the **CODE** key and press the **NEW BLOCK** key. A detailed explanation of multi-block labels can be found in the "New block" section in "For your information" (page 42).

**To input the remaining text:**

- Press  +  .

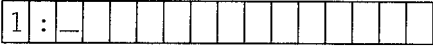
 *A block return mark appears at the end of block 1's last (and only) line. The new line is also labeled 1, meaning that it is the first line of the new block.*



- Type "Supplier:" and press  .

 *The mark for the line return has no box around it, while the block return mark is framed.*

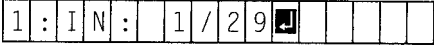
 (A block return mark)

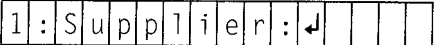
 (A line return mark)

- Type "AXZ Corporation" as the second line.

- We now want to enter the text in block 3. Press  + 

1	:	-																		
---	---	---	--	--	--	--	--	--	--	--	--	--	--	--	--	--	--	--	--	--

Now we must enter the bar code information, the last portion of our label. Although many options exist for P-TOUCH bar codes, let's assume that you wish to use CODE 39 protocol, with an unspecified number of digits. A detailed explanation of bar coding can be found in "Bar coding" on page 80 of "For your information". This explanation covers only the P-TOUCH's bar coding capabilities, however; it is not intended as a comprehensive introduction to the topic of bar coding.

**To enter Bar code mode:**

- Press  +  . The type of bar code which is currently set will be displayed briefly; then bar code input mode is entered.

B	A	R	C	O	D	E	C	O	D	E	3	9
---	---	---	---	---	---	---	---	---	---	---	---	---

↓ (Briefly)

▶	*	*	◀																
---	---	---	---	--	--	--	--	--	--	--	--	--	--	--	--	--	--	--	--

If we had wished to use a different protocol, or to change any of the default settings, we would have pressed the **FORMAT** key. However, we will use the default settings, so that we can input our data right away.

**To enter the bar code data:**

- Type our code, "158474".

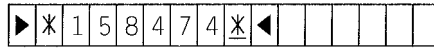

- Press



To move the cursor quickly from block to block, you can use the << and >> keys. A detailed explanation of their operation can be found in the "Cursor movement" section on page 47 of "For your information".

Our basic message is finished, so now we can consider its format. There are two types of format: global and local. Global formats determine style settings for complete labels, whereas local settings allow you to change the size, style, font, etc. of certain groups of characters within a label message. Local formatting is particularly useful for highlighting important portions of text so that they stand out prominently. A detailed explanation of these two types of format can be found on pages 68 to 71 of "For your information".

**To change global formats: FONT B TO A, BOXED TO NON-BOXED:**

- Press

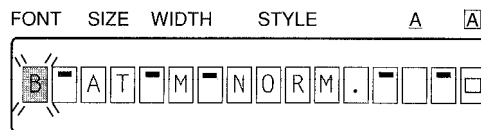

- Press



until the setting you want to change is flashing.

Then press



until the new setting that you want is displayed.

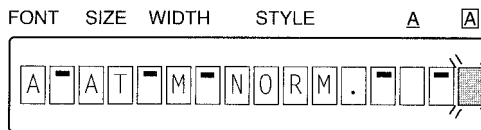

- Press

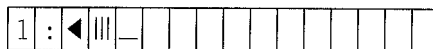
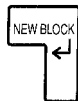

Font A will now be applied globally to all the text in our label. However, we would like to emphasize the date these parts were received – their “IN” date. To do so, we will create a local format, changing the date’s characters to bold face.

**To emphasize the IN date:**

- Press + . The cursor moves to the first character of the label message.

1 : I N : 1 / 2 9

- Press until the cursor is positioned under the 1, the first character that needs local formatting.

1 : I N : 1 / 2 9

- Press .

SELECT FIELD!

1 : I N : **1** / 2 9

(Briefly)

The 1 will flash, signifying that it will be included in the local formatting field.

- Press until the cursor is under the 9, the last character that needs local formatting. Press .

FONT SIZE WIDTH STYLE A A

A ■ A T ■ M ■ N O R M . ■ ■

- Press until the character style setting (currently set to NORMAL) is flashing.
- Use and until BOLD is displayed.

FONT SIZE WIDTH STYLE A A

A ■ A T ■ M ■ **B O L D** ■ ■

- Press . The characters “1/29” will now have their own special “local” format – bold face.

1 : I N : **F** 1 / 2 9

All the text has now been entered. The next thing to do is to print the labels out. Before printing, however, let's review some of the P-TOUCH's memory functions.

**To store the text file for future use:**

- Press  + .

M E M O R Y   S T O R E

↓ (Briefly)

[ 0 ]

- Press . The text is stored as file [0].

We can recall the file [0] which we just stored in memory.

**To recall our file:**

- Press  + . The text disappears from the working area and the confirmation message "OK TO CLEAR?" appears.

- Press .

1 : \_

- Press  + .

M E M O R Y   R E C A L L

↓ (Briefly)

[ 0 ] I N : 1 / 2 9 S u p

- Since the currently displayed file is the file that we want, press .

The storage shelf label file returns to the working area, where we can edit or print it.

1 : I N : 1 / 2 9



Sometimes, when a file is no longer useful, you will want to delete it from the P-TOUCH's memory.

**To delete a previous text file from the memory:**

- Press  + .

MEMORY DELETE? | |

↓ (Briefly)

[ | 0 | ] IN: 1 / 29  S u p

Let's assume that we no longer need file [0] and wish to delete it.  
Therefore:

- Press .

OK TO DELETE? | |

 The above message appears.

- Press  again.

 If we do not wish to delete this file, we can press  to escape.

Now let's print out the storage shelf label.

**To print the label:**

- Press  . The print options menu will be displayed.

- Press .

- When the label has been printed and the tape has stopped moving, press the cutter lever to cut off the label.

Congratulations! This completes the third and final practice session in "Learning the ropes". We hope that these exercises, which cover most of the P-TOUCH's features, have been both educational and enjoyable. If you wish, you can now go back and repeat any of these exercises, practice on your own, or begin making actual labels. If you ever have questions about particular operational points, please refer to the "For your information" section of this manual.



*For your  
information*

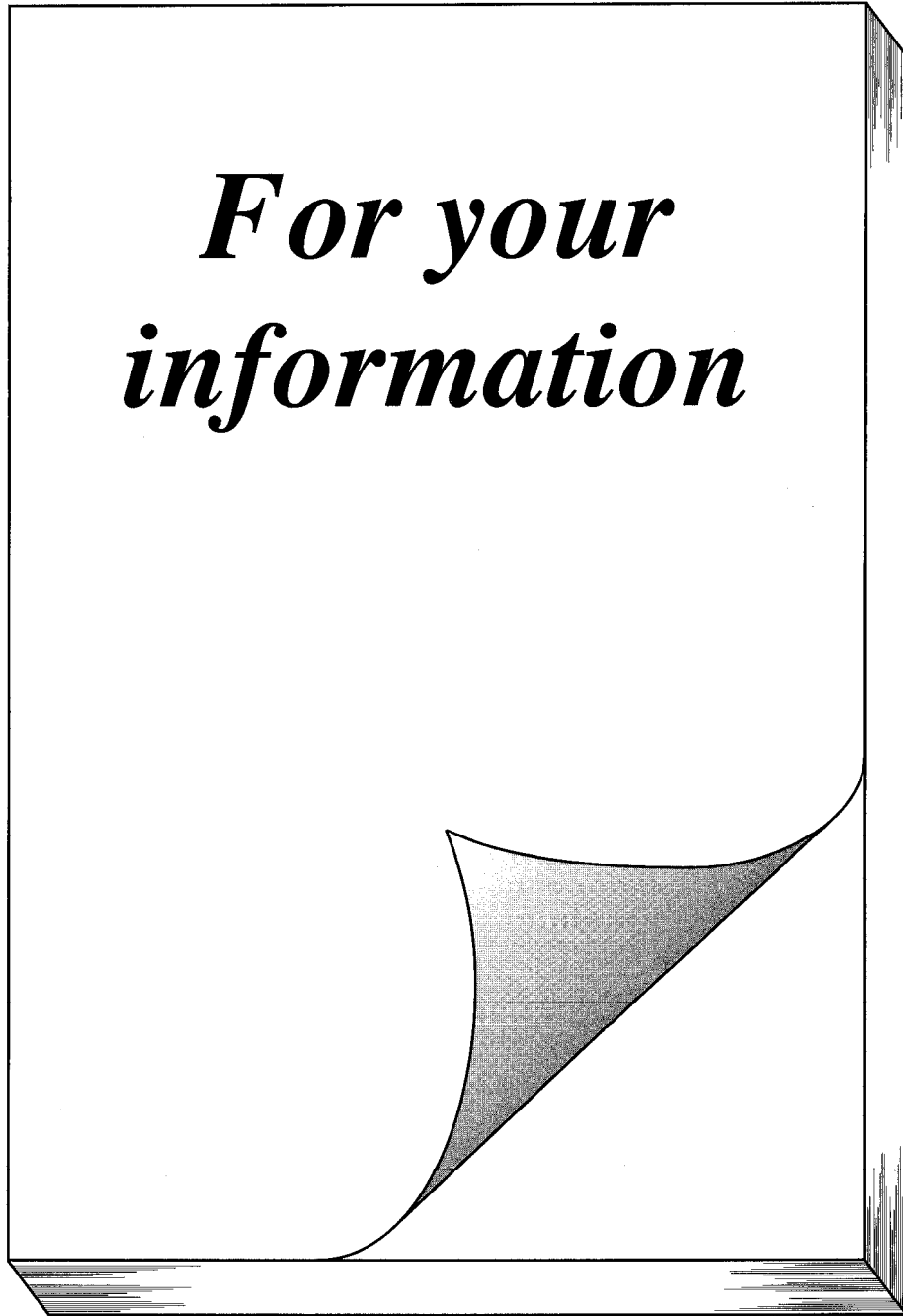

## ***INTRODUCTION (For your information)***

In “For your information” you will find detailed explanations of all the P-TOUCH’s features. Each concept is given its own page, making this reference section easy to use.

Operational examples of most features can also be found in the “Learning the ropes” practice sessions. If you are a first time P-TOUCH user, we suggest that you work through those learning exercises before starting to make labels on your own.

This “For your information” section provides supplementary information. When you have a question about a particular point, locate that topic in the “Finding your way” contents list and turn to the page indicated.

## **FINDING YOUR WAY**

This “For your information” reference guide consists of explanations of various topics plus descriptions of all the P-TOUCH’s different features and functions.

	<b>PAGE</b>		<b>PAGE</b>
On/Off Key	34	Global Formats	68
The Cursor	35	Local Formats	70
Shift, Alt, & Caps	36	Store	72
The Code Key	37	Recall	73
Symbols	38	M. Delete	75
Composite Characters	39	Printing & Tape Feed	77
Return	40	Bar Coding	80
New Block	42	Using the Tape Separator/ Lettering Stick	85
Sequential Numbering	43		
Cancel	46		
Cursor Movement	47		
Entering Text	48		
Backspace	49		
Line Out	50		
Clear	51		
Basic Formatting Principles	52		
Format Settings:			
Font	54		
Size	55		
Width	56		
Style	58		
Underline	60		
Framing	61		
Length	62		
Horizontal Alignment	63		
Vertical Alignment	64		
Vertical Printing	65		
Mirror Printing	67		

## ON/OFF KEY

### BACKGROUND

The P-TOUCH's On/Off key is located on the top row of keys on the left-hand side of the keyboard. When the power is turned on, the previous work session's information is displayed.

The machine's internal memory retains the last message created and displays it when you turn on the machine. This automatic back-up feature allows you to stop work on a message, turn off the machine, and return to it later without having to re-enter the message. In addition, an auto power-off function has been included on the P-TOUCH. If there is no input for 5 minutes, the P-TOUCH will power off automatically and still retain the text.

 *The P-TOUCH protects your work from power loss. Even if a machine with no batteries in it is unplugged, all data in the machine's memory will be retained for approximately five minutes. If no power is provided for more than five minutes, however, all text and formats in memory will be lost.*

*Do not unplug the AC adaptor while the power is on, as this may cause all your data to be lost. Always turn off the P-TOUCH using the On/Off key first and then unplug the AC adaptor.*

*The On/Off key can also be used to "reset" the P-TOUCH.*

This reset function is useful in two situations:

- (1) To clear all text files and formats from the machine's memory.
- (2) To return the machine to a usable state if it has locked up (that is, it does not respond to key presses).

### TO RESET THE MACHINE

Turn the power OFF.

Turn the power back ON, while holding down the **CODE** and **"R"** keys.

 *Since all text files and formats will be deleted from the P-TOUCH's memory, this should only be done as a last resort.*

# THE CURSOR

## BACKGROUND

The P-TOUCH has two different types of cursor.

The first, which resembles an underline, marks your current position in the text. Its operation is nearly identical to that of cursors on typewriters or word processors. You can review and edit different parts of your message by moving the cursor backwards, forwards, up and down. Eight keys (◀, ▶, ▲, ▼, ◀◀ (to the previous block), ▶▶ (to the following block), **HOME** and **END**) let you move the cursor. Their operations are explained in the "Cursor movement" section on page 47.

While the text cursor is used to mark or select points in text messages, another sort of cursor allows you to choose characters and various settings. When an item flashes (or is highlighted), that item is presently "active". For example, if **BOLD** is flashing on the format display, bold characters are the current text style. Also, when you select text fields for numbering or local formatting, the characters that are currently selected will flash.

Both of these cursors – the text cursor for pointing and the flashing cursor for choosing – help you create, view and edit label messages.

## EXAMPLE

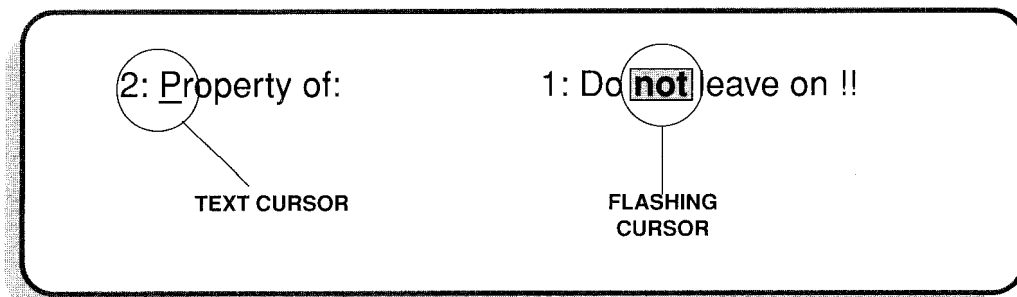

# SHIFT, ALT, & CAPS

## BACKGROUND

Most characters can be entered simply by pressing their keys. However, to enter upper case letters, accented characters and the most common symbols, three special keys are necessary.

**SHIFT KEY:** This key allows you to type capital letters and symbols located on the upper part of a key. To type a capital "A", hold down the **SHIFT** key and press the "A" key.

**CAPS KEY:** The **SHIFT** key is very useful for inputting a single capital letter; for example, at the beginning of a name. However, when you wish to enter a series of capital letters, the **CAPS** key should be used.

### TO ENTER CAPS MODE

Hold down the **CODE** key and press the **CAPS** key.

A message, "CAPS ON" appears on the display briefly.

 *When Caps mode is on, using the **SHIFT** key and typing will produce lower-case letters.*

In Caps mode, upper-case letters are typed simply by pressing the character keys (that is, you do not hold down the **SHIFT** key). However, when number keys are pressed, numbers (not the symbols above them) appear. To type a symbol printed on the upper part of a key, hold down the **SHIFT** key and press the key.

To exit Caps mode, hold down the **CODE** key and press the **CAPS** key again. A message, "CAPS OFF", appears briefly on the display.

**ALT KEY:** The **ALT** key allows you to input characters and symbols printed on the right side of a key.

### TO ENTER A CHARACTER ON A KEY'S RIGHT SIDE

Press the **ALT** key.

Hold down the **ALT** key and press the key with a character on its right side.



## THE CODE KEY

### BACKGROUND

While the **SHIFT**, **CAPS** and **ALT** keys allow you to select various characters and symbols, the **CODE** key allows you to choose various functions and modes. Functions and modes printed in green on the keyboard require you to press the **CODE** key to select them.

### EXAMPLE

To use the memory recall function:

- Press  +  .

To enter symbol mode:

- Press  +  .

# SYMBOLS

## BACKGROUND

The P-TOUCH has many special marks and symbols that can be included in your text message. When entered, they act like normal characters and can be both edited and deleted.

In addition to the symbols that can be found on the P-TOUCH's key tops, there are also special symbols which are available in Symbol mode.

## OPERATION

### TO ENTER A NON-KEY TOP SYMBOL

- (1) Move the cursor to the point at which you want to enter the symbol mark.
- (2) Press the **CODE** key and the **SYMBOL** key to enter Symbol mode.
- (3) Press the ▲ and ▼ keys until the symbol group containing the symbol you wish to enter appears on the display.
- (4) Press the ► and ◀ keys until the symbol you require flashes.
- (5) Press the **RETURN** key to enter the symbol into your message.

## LIST

S Y M B O L : ↑ ↓ → ← ↶ ↷ ↸ ↹ +

S Y M B O L : ➡ ⬅ ↕ ⬇ ⊕ ⊙ ™ 📧 📧

S Y M B O L : ★ ● ○ □ Ⓜ ♪ ♯ ♫ ♿

S Y M B O L : ♂ ♀ ☘ 🌻 ⚡ ⚔ 📱 🕒 ♀

S Y M B O L : 🍷 🌸 🗑 ♣ ❗ 📧 📧 📧

S Y M B O L : Ⓜ Ω ∼ = □ ⚡ Δ ∞ †

S Y M B O L : √ 2 3 4 5 6 7 8 9

S Y M B O L : 1/3 f ℓ α β γ δ μ ÷

# COMPOSITE CHARACTERS

## BACKGROUND

In foreign languages which use the Roman alphabet, composite characters, consisting of a letter and a diacritical mark are often used. These characters can be entered on the P-TOUCH. The diacritical marks available are as follows:

¨, ´, ` and ~.

Several composite characters can be found on the key tops. Characters such as Ç, ç, Ñ and ñ can be entered in the same way as other characters. Other composite characters can be entered using a letter and a diacritical mark. Before inputting a composite character using the method described below, check to see whether it is available as a key-top character or not.

Diacritical Mark	Letters which can be used with
¨	A E I O U a e i o u y
´	A E I O U a e i o u
`	A E I O U a e i o u
^	A E I O U a e i o u
~	A N O a n o

## OPERATION

### TO INPUT A COMPOSITE CHARACTER

- (1) Enter the diacritical mark needed for the composite character.
- (2) Type the letter you wish to use with it. The entered mark and character will flash alternately on the LCD display and will be printed together when you print your label.

 *If the letter cannot be combined with the diacritical mark (see the chart above), the letter will take the place of the mark. (i.e. the diacritical mark will be deleted).*

*If you press the **PRINT** key after inputting only the diacritical mark, nothing will happen. To continue inputting your message, you must either successfully enter a composite character or delete the mark with the **CANCEL** or **BS** key.*

# RETURN

## BACKGROUND

The **RETURN** key is located on the right-hand side of the P-TOUCH's keyboard. It is the largest and one of the most frequently used keys. The **RETURN** key has three basic functions:

### FOR ENDING A LINE

Like the RETURN key on a typewriter or word processor, the P-TOUCH's **RETURN** key lets you end one line of text and begin another. During message input, when you have finished entering one line and wish to start the next, press the **RETURN** key. A ↵ mark will appear on the LCD display.

1 : N e w Y o r k , N Y \_

Press the **RETURN** key.

2 : \_

 *The maximum number of text lines in a single block is five. If the cursor is located on line 5 and you press the **RETURN** key, an error message will appear.*

Tape	Maximum number of lines that can be printed
24 mm (1")	5
18 mm (3/4")	5
12 mm (1/2")	3
9 mm (3/8")	3
6 mm (1/4")	2

### FOR ENTERING AND CHOOSING ITEMS

The **RETURN** key can also be used to enter and choose items. For example, in Symbol mode a large group of symbols is displayed. One of them flashes, signifying that it is the "active" symbol. If the **RETURN** key is pressed, that symbol is entered into your text message. Also, after creating a text format, pressing the **RETURN** key chooses the currently displayed settings, which are then applied to the current label.

### FOR SAYING "YES"

Sometimes prompts appear on the LCD display, especially when something you wish to do will delete or affect existing files. In these cases, pressing the **RETURN** key is like giving an affirmative answer. To say "No", press the **CANCEL** key.

(when deleting everything)

O	K		T	O		C	L	E	A	R	?			
---	---	--	---	---	--	---	---	---	---	---	---	--	--	--

— If "Yes", press the **RETURN** key.

— If "No", press the **CANCEL** key.

## NEW BLOCK

### BACKGROUND

Whenever the number of lines in a label changes, a new block must be created. Creating a new block is different from local formatting, however, which changes the type style within a given line or group of lines.

Compare these two labels:

AXZ CORP. (052)824-2755
-------------------------

This is simply a single-block, single-line label with local formatting. After all the text has been typed in, the portion "(052) 824-2755" is assigned a smaller character size.

B-819	Supplier	IN: 5/28
	AXZ Corporation	OUT: 6/13
	Main Street Fartown, OH	

This is a multi-block label. The first portion of this label is a single line, the second, four lines, and the third, two. Therefore, when you enter the text message, you must use the **NEW BLOCK** key.

After typing the first block of text, press the **CODE** key and the **NEW BLOCK** key. A block return mark (  ) will appear on the LCD display at the end of the first block.

 *The maximum number of blocks in a single label is ten. If the cursor is located in block 10 and you press the **CODE** and **NEW BLOCK** keys, an error message will appear.*

*When the cursor is positioned in the middle of a text block, pressing the **CODE** and **NEW BLOCK** keys causes the current block to be split in two. A block return mark will be added at the cursor position and the lines which follow will be re-numbered.*

### OPERATION

#### TO ENTER THE TEXT FOR THE LABEL

TOMMY	CLASS 2
	ROOM 104

- (1) Type "TOMMY".
- (2) Since the next portion of text is a new, two-line block, press the **CODE** key and the **NEW BLOCK** key.
- (3) Type "CLASS 2".
- (4) Press the **RETURN** key.
- (5) Type "ROOM 104".

# SEQUENTIAL NUMBERING

## BACKGROUND

The P-TOUCH's numbering feature allows you to designate a group of numbers and/or letters, or a bar code as a "numbering" field. When a label is printed, the numbers, letters or bar code included in the field automatically increase by one. For example, 124 becomes 125. This type of automatic incrementation is very useful for printing serial number labels for controlling inventory and other labels requiring ascending codes.

## OPERATION

The procedure for using numbers and letters for numbering and the procedure for using a bar code for numbering differ slightly from one another.

### TO DESIGNATE NUMBERS AND/OR LETTERS AS A NUMBERING FIELD

- (1) Position the cursor under the first character (number or letter) that you wish to include.
- (2) Hold down the **CODE** key and press the **SEQUENTIAL NUMBERING** key. "SELECT FIELD" will appear briefly; then the selected character will flash, indicating that it is "active".
- (3) Use **▶** and **◀** keys to move the cursor to the final character that you wish to include. All characters between it and the first character will also flash.
- (4) Press the **RETURN** key. Numbering marks (┌N N┐) will appear on the display, surrounding the numbering field (the characters that were flashing previously).
- (5) Press the **PRINT** key. The "Print settings" selection menu will appear.
- (6) Press the **▶** key until the "INCREASES" setting flashes.
- (7) Press the **▲** and **▼** keys until your desired setting is displayed. If you want the number to count up from 10 to 15, set "INCREASES" to "6" (10, 11, 12, 13, 14, 15 is 6 steps).
- (8) Press the **RETURN** key.



*In any text message, only one numbering field can be created.*

*The maximum number of characters in a numbering field is ten.*

*A numbering field must be located entirely within one line of text.*

*If one of the numbering marks is deleted, both disappear and the characters that made up the numbering field are treated thereafter as regular text.*

## TO DESIGNATE A BAR CODE AS A NUMBERING FIELD

- (1) Position the cursor under the "◀" or the "|||" of the "◀|||" in the bar code.
- (2) Hold down the **CODE** key and press the **SEQUENTIAL NUMBERING** key.
- (3) Now you can apply the numbering function to the bar code. Numbering marks (「N N」) will appear on the display, surrounding the numbering field.
- (4) Press the **PRINT** key. The "Print settings" selection menu will appear.
- (5) Press the ▶ key until the "INCREASES" setting flashes.
- (6) Press the ▲ and ▼ keys until your desired setting is displayed. If you want the number to count up from 10 to 15, set "INCREASES" to "6" (10, 11, 12, 13, 14, 15 is 6 steps).
- (7) Press the **RETURN** key.

☞ *A bar code numbering field cannot contain any additional numbers or letters.*

*Only numbers may be used in a bar code numbering field. A non-bar code numbering field can use the following number and letter ranges:*

0	→	1	→	....	9	→	0	→	....
A	→	B	→	....	Z	→	A	→	....
a	→	b	→	....	z	→	a	→	....

*Spaces can be used to adjust the number of digits printed:*

「NON」	0	→	1	→	....	9	→	0	→	....
「N ON」	0	→	1	→	....	99	→	0	→	....
「NAON」	A0	→	A1	→	....	A9	→	B0	→	....

*Spaces between numbering characters simply adjust the space between them on the printed labels:*

「N 1 2 3 N」	1 2 3	→	1 2 4
-------------	-------	---	-------

*Non-alphanumeric characters within the numbering field are printed but are not changed or incremented in any way.*

*In a bar code, only numbers can be included for automatic numbering. The numbering can run from 0 to 999.*

▶ * 123ABCD999 *	◀
↓	
▶ * 123ABCD000 *	◀



*In a CODE 39 format bar code, the character immediately before the asterisk is the character which changes. If the check digit feature is on, the two characters before the asterisk both increase in value as automatic numbering proceeds.*

*In a CODABAR format bar code, the character immediately before the END code changes.*

*According to the ISBN numbering standard, only the first 12 digits of a number are incremented.*

# CANCEL

## BACKGROUND

The **CANCEL** key is located on the bottom of the keyboard on the right-hand side. It has two basic functions.

### FOR LEAVING AN OPERATION MODE WITHOUT TAKING ANY ACTION

In general, the **CANCEL** key returns you to the previous screen or activity. Therefore, if you enter a particular operation mode but decide that you want to return to text entry or editing, you can press the **CANCEL** key.

1:Sales Manager\_

Press the **FORMAT** key. Format editing mode is entered.

A - A T - M - N O R M . - -

To escape from Format mode without changing any settings, press the **CANCEL** key.

2:Sales Manager\_

You return to Text entry mode, the previous screen.

### FOR SAYING "NO"

Sometimes prompts appear on the LCD display, especially when something you wish to do will delete or affect existing files. In these cases, pressing the **CANCEL** key is like giving a negative answer. To say "Yes", press the **RETURN** key.

(when deleting all existing files) DELETED ALL MEM.?

— If "No", press the **CANCEL** key.

— If "Yes", press the **RETURN** key.

# CURSOR MOVEMENT

## BACKGROUND

After you have created a message, moving the cursor allows you to view or edit the text. The cursor can move left and right within a line. When the up and down arrow keys, ▲ and ▼, are pressed, the cursor moves to the previous text row or to the following row.



In general, pressing this key moves the cursor one space to the left. If the cursor is positioned under the first character of a line when this key is pressed, the cursor moves to the end of the previous line.

Holding down the **CODE** key and pressing this key makes the cursor move to the first character of the current text block. If they are pressed together again, the cursor moves to the first character of the previous block.



In general, pressing this key moves the cursor one space to the right. If the cursor is positioned at the end of a line and this key is pressed, the cursor moves to the beginning of the next line.

Holding down the **CODE** key and pressing this key makes the cursor move to the first character of the next text block.



Pressing this key moves the cursor to the first character of the previous line.

Holding down the **CODE** key and pressing this key moves the cursor directly to the first character of the entire message.



Pressing this key moves the cursor to the first character of the next line.

Holding down the **CODE** key and pressing this key moves the cursor directly to the last character of the entire message.

# ENTERING TEXT

## BACKGROUND

The P-TOUCH is operated in Insert mode. That is, you can insert characters into the middle of your message. Characters are inserted at the current cursor position and all characters after the insertion point move one space to the right.

## EXAMPLE

The diagram shows a text input field with a cursor under the 'o' in 'open'. The text is displayed in a grid of boxes: 1: P u l l o p e n. A bullet point indicates the action: 'Type "to" and add a space.' The second grid shows the result: 1: P u l l t o o p e n. The cursor is now under the 'o' in 'open', and the text 'to' has been inserted before it, shifting the original 'o' and 'pen' to the right.

# BACKSPACE

## BACKGROUND

The **BS** key allows you to remove unwanted characters from your message. It differs from the ◀ key. The ◀ key simply moves the cursor without changing the message, while the **BS** key removes the preceding character.

## OPERATION

### TO DELETE A CHARACTER

- (1) Using the cursor movement keys, position the cursor one space to the right of the character which you want to delete.
- (2) Press the **BS** key.

## EXAMPLE

### General operation:

1 : P u l l t o o p e n

- Press  three times.

1 : P u l l o p e n

If the cursor is positioned under the first character in a line when  is pressed, the preceding line's return mark is deleted and the two lines are joined.

2 : X Y Z

- Press .

1 : A B C D X Y Z

 Bar code marks, numbering field marks and local format marks can also be deleted using the **BS** key.

# LINE OUT

## BACKGROUND

The **LINE OUT** key allows you to remove an unwanted line of text from your message. Anything other than a block return mark (i.e. return marks, symbols, bar codes or numbering marks) is also deleted.

## OPERATION

### TO DELETE A LINE OF TEXT

- (1) Using the cursor movement keys, position the cursor within the line which you want to delete.
- (2) Hold down the **CODE** key and press the **LINE OUT** key.

#### General operation:

1 : C L O S E D \_

- Press **CODE** + **LINE OUT**.

1 : \_

If the cursor is positioned in a line with a block return mark (␣) when **LINE OUT** is pressed, the mark remains.

2 : 2 4 7 | M a i n | R o a d | ␣

- Press **CODE** + **LINE OUT**.

1 : \_

1 : A X Z | C o m p a n y | ␣

# CLEAR

## BACKGROUND

The **CLEAR** key allows you to remove all text, return marks, block return marks etc. from the working area. In other words, the current text is deleted completely. You can then begin entering an entirely new text message.

## OPERATION

### TO CLEAR A TEXT FILE

- (1) Hold down the **CODE** key and press the **CLEAR** key.
- (2) Press the **RETURN** key.

 *The cursor can be positioned anywhere.*

## EXAMPLE

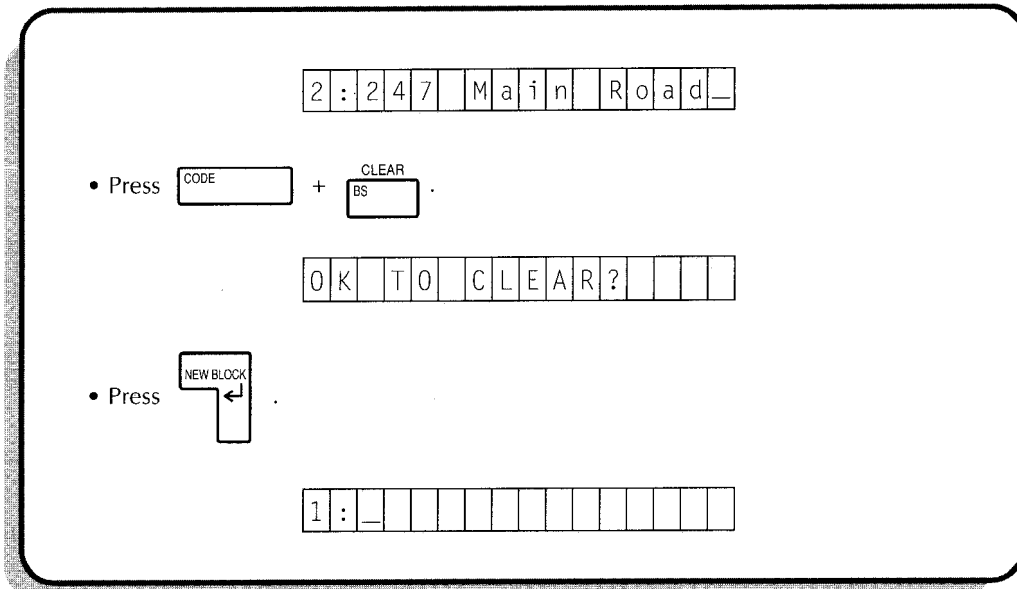

2: 247 Main Road\_

- Press **CODE** + **CLEAR** (BS).

OK TO CLEAR?

- Press **NEW BLOCK** (↩).

1: \_

# BASIC FORMATTING PRINCIPLES

## BACKGROUND

The text you enter, plus the return and block return marks, will eventually be printed out as your label. The text's appearance is determined by the formats you select. Formats determine the size and typeface of the text, as well as its alignment and orientation. Two types of formats exist: global and local.

 On pages 54 to 67 various format settings are explained. At the top of each page is an LCD display diagram showing where the particular setting can be found. In the top right-hand corner of the page "YES" or "NO" indicates whether the setting can be assigned in global formatting and local formatting.

Global formatting allows you to set the items shown both above and below the LCD. Global format settings are shown on two separate screens known as the upper and lower screens.

Press the **FORMAT** key to view the upper screen and then press the **CODE** and ▼ key to switch from the upper screen to the lower, and the **CODE** key and ▲ key to switch from the lower screen to the upper (alternatively, if the cursor is at either the first or last setting on the current screen, you can simply use the ◀ or ▶ key to switch screens).

The setting values which appear on the LCD on the upper and lower screens correspond respectively to the items displayed above and below the LCD display. Solid blocks between the settings show whether the current screen is the upper or lower screen. If the current screen is the upper screen, the solid blocks are in the upper half of the display, and if the current screen is the lower screen, the blocks are in the lower half of the display.

Local formatting allows you to set only those settings printed above the LCD. To view the local format settings, first position the cursor within the local format field, then press the **LOCAL FORMAT** key. Solid blocks between the settings are the same height as the characters on the screen.



## GLOBAL FORMATS

You must choose a global format for your label; this can be done before, during or after text entry. The global format is a general format that is applied to all characters except those which have a local format assigned to them. In many cases your entire message will consist of characters of the same size and style. This collection of all-encompassing style settings is known as a global format.

To view the current format settings, press the **FORMAT** key, which is marked with the word "FORMAT".

 *Detailed information concerning global format creation and editing can be found in the "Global formats" section on page 68.*

## LOCAL FORMATS

Every label is assigned a global format – style settings for the entire message. However, you may sometimes wish to give a word or group of words their own special format in order to emphasize them. A local format contains settings similar to those in a global format, but is applied only to a selected group of characters within the message.

 *Detailed information concerning local format creation and editing can be found in the "Local formats" section on page 70.*

# FONT

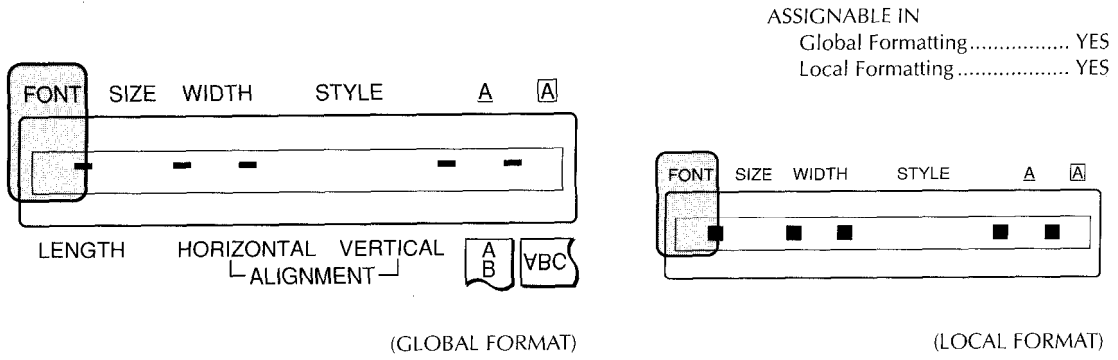

## BACKGROUND

Two different typefaces, or fonts, are available on the P-TOUCH. They are:

- Font A
- Font B

## OPERATION

### TO SELECT A FONT

After entering Format or Local format mode:

- (1) Press the ► key until the FONT field flashes.
- (2) Press the ▲ or ▼ key until the name of the font you wish to use ("A" or "B") is displayed.
- (3) Press the RETURN key.

## EXAMPLE

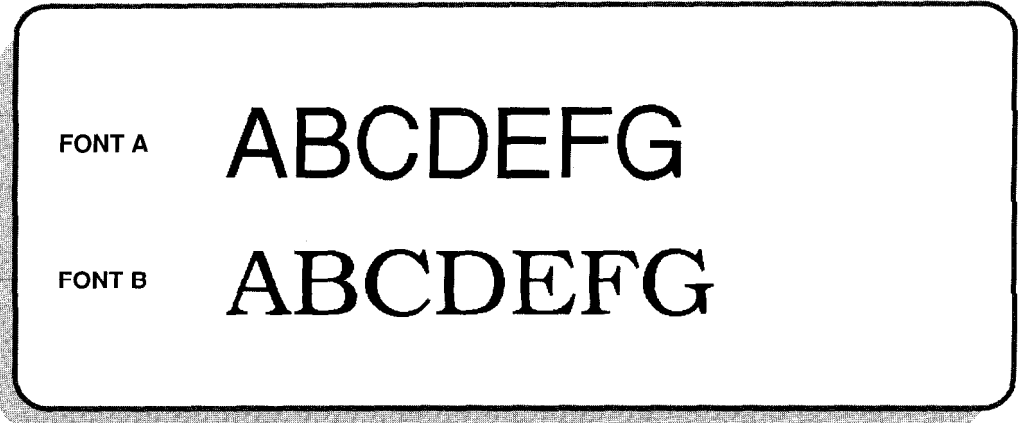

# SIZE

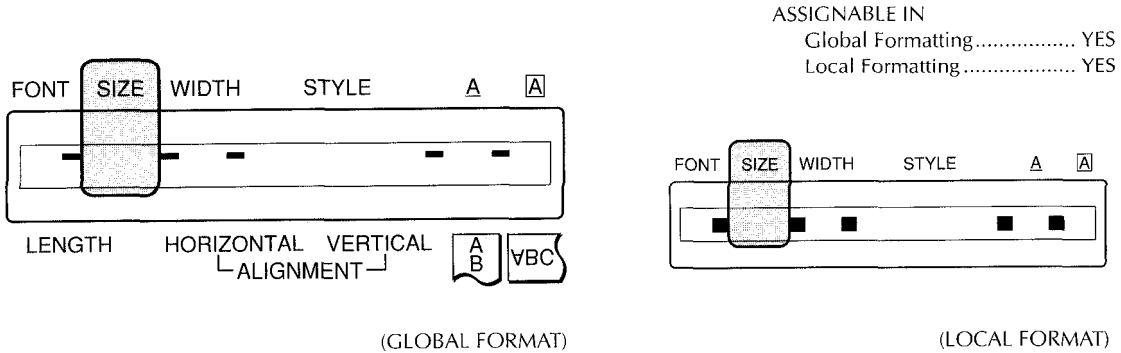

## BACKGROUND

There are two ways of setting character size: automatic and manual.

*In many cases you will want to use the largest characters possible for a given tape and message. If "AUTO" ("AT") size is selected, the P-TOUCH compares your inputted message with the tape size and automatically uses the largest characters possible. If the text includes descending lower case characters or accented characters (such as "Ä" or "Ñ"), a font size slightly smaller than the maximum possible will be used, to allow space on the tape for the characters with descenders (such as "g" or "p") or the accents. If the text contains no descending or accented characters, the maximum possible font size is used.*

In some cases, however, you will want to assign a character size regardless of tape width or message length. Six point sizes are available, and each can be printed in three widths: NARROW, MEDIUM or WIDE. The available sizes are:

- 6, 10, 13, 19, 26 & 38 points [characters of all sizes can be NARROW (N), MEDIUM (M) or WIDE (W)]
- + AUTO (AT)

## OPERATION

### TO SELECT A SIZE

After entering Format or Local format mode:

- (1) Press the **▶** key until the SIZE field flashes.
  - (2) Press the **▲** or **▼** key until the size you wish to use is displayed.
- To select "AT", simply press the **SPACE** key.
- (3) Press the **RETURN** key.

# WIDTH

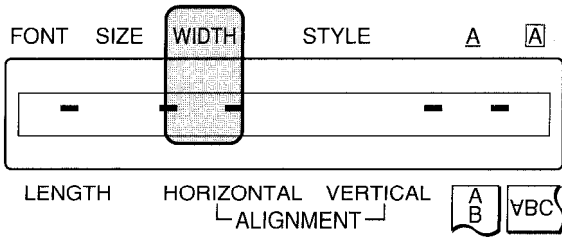

(GLOBAL FORMAT)

ASSIGNABLE IN  
 Global Formatting..... YES  
 Local Formatting..... YES

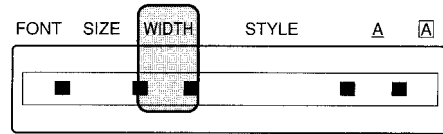

(LOCAL FORMAT)

## BACKGROUND

When you have selected a font size, you can select one of the following three widths:

- MEDIUM (M)
- NARROW (N)
- WIDE (W)

## OPERATION

### TO SELECT A WIDTH

After entering Format or Local format mode:

- (1) Press the **▶** key until the WIDTH field flashes.
- (2) Press the **▲** or **▼** key until the width you wish to use is displayed.
- ☞ *To select "M", simply press the **SPACE** key.*
- (3) Press the **RETURN** key.

**EXAMPLE**

Select the type you require by choosing a combination of character size and width from those shown below.

WIDTH SIZE	WIDE (W)	MEDIUM (M)	NARROW(N)
38pt	ABC	ABC	ABC
26pt	ABC	ABC	ABC
19pt	ABC	ABC	ABC
13pt	ABC	ABC	ABC
10pt	ABC	ABC	ABC
6pt	ABC	ABC	ABC

(Actual size)

# STYLE

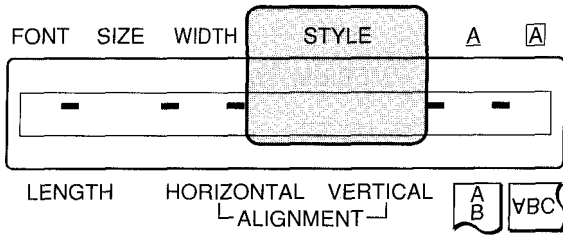

(GLOBAL FORMAT)

ASSIGNABLE IN  
 Global Formatting..... YES  
 Local Formatting..... YES

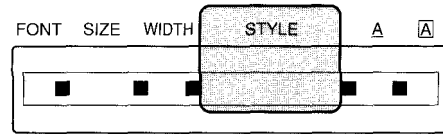

(LOCAL FORMAT)

## BACKGROUND

A total of ten character styles are available: six single styles and four combinations. They are:

- |                  |                           |
|------------------|---------------------------|
| NORMAL (NORM.)   | ITALIC & OUTLINE (I+OUT)  |
| OUTLINE (OUTL.)  | ITALIC & BOLD (I+BLD)     |
| BOLD (BOLD)      | ITALIC & SHADOW 1 (I+SH1) |
| SHADOW 1 (SHAD1) | ITALIC & SHADOW 2 (I+SH2) |
| SHADOW 2 (SHAD2) |                           |
| ITALIC (ITAL.)   |                           |

☞ *When you use small characters, some style settings (e.g. ITALIC + SHADOW2) may produce printed output that is hard to read.*

## OPERATION

### TO SELECT A STYLE

After entering Format or Local format mode:

- (1) Press the ► key until the STYLE field flashes.
- (2) Press the ▲ or ▼ key until the style you wish to use is displayed.

☞ *To select "NORM.", simply press the **SPACE** key.*

- (3) Press the **RETURN** key.

EXAMPLE

	NORM.	OUTL.	BOLD
A FONT	ABCDE	ABCDE	ABCDE
B FONT	ABCDE	ABCDE	ABCDE

	SHAD1	SHAD2	ITAL.
A FONT	ABCDE	ABCDE	<i>ABCDE</i>
B FONT	ABCDE	ABCDE	<i>ABCDE</i>

  

	I+OUT	I+BLD
A FONT	<i>ABCDE</i>	<b><i>ABCDE</i></b>
B FONT	<i>ABCDE</i>	<b><i>ABCDE</i></b>

	I+SH1	I+SH2
A FONT	<i>ABCDE</i>	<i>ABCDE</i>
B FONT	<i>ABCDE</i>	<i>ABCDE</i>

# UNDERLINE

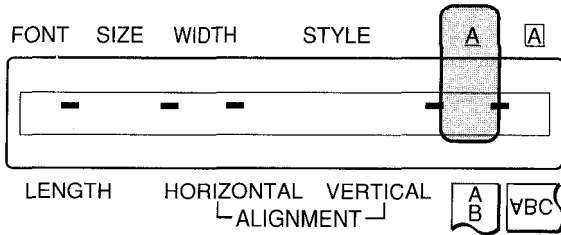

(GLOBAL FORMAT)

ASSIGNABLE IN  
Global Formatting..... YES  
Local Formatting..... YES

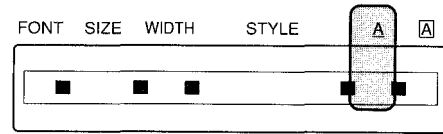

(LOCAL FORMAT)

## BACKGROUND

Characters in your message can be printed with or without underlining. Underlining can be selected both globally (for all characters in a message) and locally (for a selected group of characters). When underlining is on (▲), characters will be printed underlined.

## OPERATION

### TO TURN UNDERLINE MODE ON/OFF

After entering Format or Local format mode:

- (1) Press the ► key until the UNDERLINE ( A ) field flashes.
- (2) Press the ▲ or ▼ key until the setting you want is displayed (the ▲ symbol indicates that the underline function is on).

 Press the **SPACE** key to turn off Underline mode.

- (3) Press the **RETURN** key.

 When you select Underline mode for vertical printing, the underline appears to the left of the text.



# FRAMING

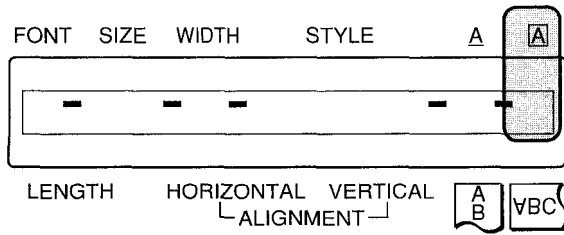

(GLOBAL FORMAT)

ASSIGNABLE IN  
 Global Formatting..... YES  
 Local Formatting..... YES

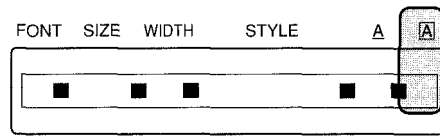

(LOCAL FORMAT)

## BACKGROUND

Characters in your message can be boxed () or framed () : a rectangle is drawn around the selected characters. The rectangle can have either round or square corners. Boxing and framing can be selected both globally (for all characters in a message) and locally (for a selected group of characters) as follows:



## OPERATION

### TO TURN FRAMING MODE ON/OFF

After entering Format or Local format mode:

- (1) Press the **▶** key until the FRAMING () field flashes.
- (2) Press the **▲** or **▼** key until the setting you want is displayed ( indicates that boxing is selected,  indicates framing).

 Press the **SPACE** key to turn off Framing mode.

- (3) Press the **RETURN** key.

# LENGTH

ASSIGNABLE IN  
Global Formatting..... YES  
Local Formatting..... NO

FONT SIZE WIDTH STYLE A A

LENGTH HORIZONTAL VERTICAL ALIGNMENT A B VBC

(GLOBAL FORMAT)

## BACKGROUND

There are two methods for setting the label length. With the "AUT" length setting, the P-TOUCH automatically adjusts the label length to fit your message. Sometimes, however, you may want to set a label length that is not governed by the message's size. The label length can be set from 2.0" to 8.5" in increments of 0.1". If you hold down the ▲ or ▼ key, the length setting will change in increments of 0.5". The available sizes are:

AUT 2.0 2.1 .... 8.5 AUT ... (in increments of 0.1")

## OPERATION

### TO SELECT A TAPE LENGTH

After entering Format mode:

- (1) Press the ► key until the LENGTH field flashes.
- (2) Press the ▲ or ▼ key until the length you wish to use is displayed.
  - ☞ To avoid scrolling through all the various length choices, you can select "AUT" by pressing the **SPACE** key.
- (3) Press the **RETURN** key.
  - ☞ The length setting can only be made globally. It is not available as a local format.

# HORIZONTAL ALIGNMENT

ASSIGNABLE IN  
 Global Formatting ..... YES  
 Local Formatting ..... NO

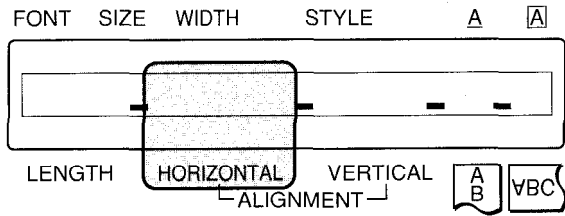

(GLOBAL FORMAT)

## BACKGROUND

Characters in your message's blocks can be horizontally aligned in four different ways:

- LEFT (LEFT)
- CENTER (CTR)
- RIGHT (RGHT)
- JUSTIFY (JUST)

## OPERATION

### TO SELECT A HORIZONTAL ALIGNMENT

After entering Format mode:

- (1) Press the ► key until the HORIZONTAL ALIGNMENT field flashes.
- (2) Press the ▲ or ▼ key until the horizontal alignment setting you wish to use is displayed.

☞ To select "LEFT", simply press the **SPACE** key.

- (3) Press the **RETURN** key.

☞ The horizontal alignment setting can only be made globally. It is not available as a local format.

*When a multi-block message on a tape of a selected length is justified using the "JUST" setting, the space between blocks is adjusted so that the message is evenly distributed along the entire length of the tape.*

## EXAMPLE

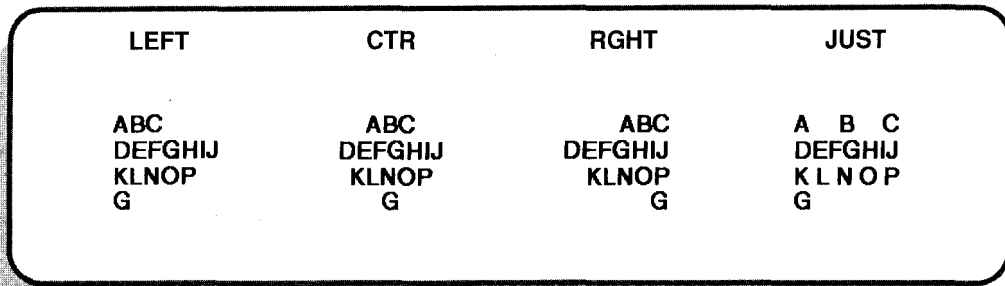

# VERTICAL ALIGNMENT

ASSIGNABLE IN  
 Global Formatting..... YES  
 Local Formatting..... NO

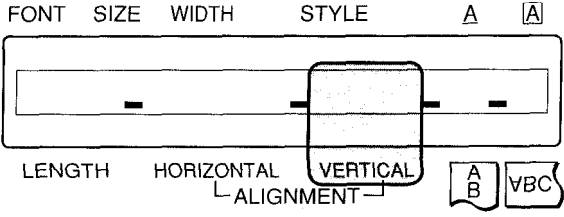

(GLOBAL FORMAT)

## BACKGROUND

Lines of characters in your message's blocks can be vertically aligned in three different ways:

- BOTTOM (BTM)
- CENTER (CTR)
- TOP (TOP)

## OPERATION

### TO SELECT A VERTICAL ALIGNMENT

- After entering Format mode
- (1) Press the **▶** key until the VERTICAL ALIGNMENT field flashes.
  - (2) Press the **▲** or **▼** key until the vertical alignment setting you wish to use is displayed.
    - ☞ To select "BTM", simply press the **SPACE** key.
  - (3) Press the **RETURN** key.
    - ☞ The vertical alignment setting can only be made globally. It is not available as a local format.

## EXAMPLE

TOP	ABCABC <sup>ABCDE<sup>ABC</sup></sup>
CTR	ABCABC <sub>ABCDE<sub>ABC</sub></sub>
BTM	ABCABC <sub>ABCDE<sub>ABC</sub></sub>

# VERTICAL PRINTING

ASSIGNABLE IN  
 Global Formatting..... YES  
 Local Formatting ..... NO

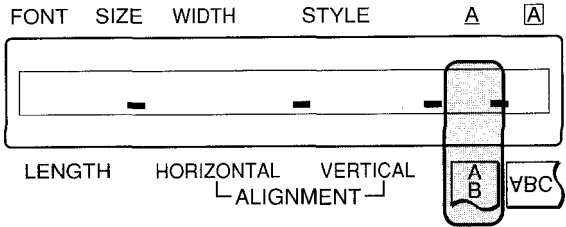

(GLOBAL FORMAT)

## BACKGROUND

Characters in your message can be printed so that they appear vertically along the length of the label. When vertical printing ( ) is on ( ▼ ), messages will be printed vertically.

## OPERATION

### TO TURN VERTICAL PRINTING ON AND OFF

After entering Format mode:

- (1) Press the ► key until the VERTICAL PRINTING field flashes.
- (2) Press the ▲ or ▼ key until the setting you wish to use is displayed (the ▲ symbol indicates that the vertical printing function is on).

Press the **SPACE** key to turn off vertical printing.

- (3) Press the **RETURN** key.

The limitations on the number of lines that can be printed in vertical printing mode are as follows:

Tape	Maximum number of lines that can be printed
24 mm (1")	5
18 mm (3/4")	5
12 mm (1/2")	3
9 mm (3/8")	3
6 mm (1/4")	2

☞ () [] {} « » will be printed as follows:

(A)  
(B)  
(C)

**EXAMPLE**

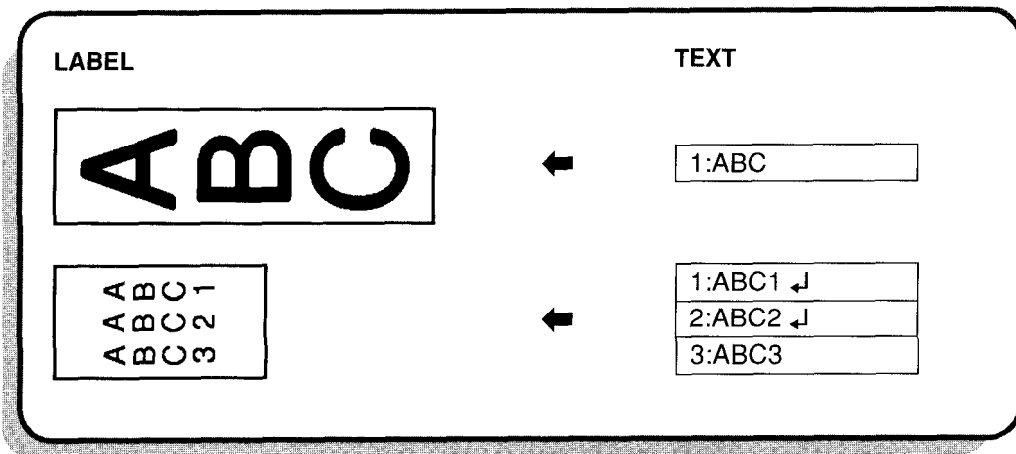

# MIRROR PRINTING

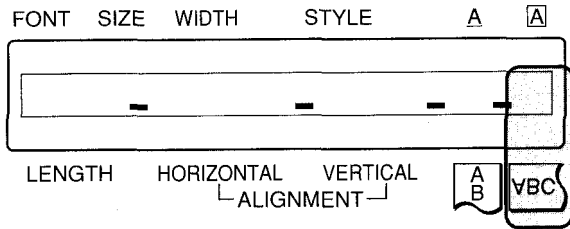

(GLOBAL FORMAT)

ASSIGNABLE IN  
 Global Formatting..... YES  
 Local Formatting..... NO

## BACKGROUND

Your message can be printed in mirror orientation. When a mirror image label *printed on transparent tape is fixed to the inside of a window facing outwards*, it can be read from the opposite side. Mirror image labels could be used, for example, on a showroom window. When mirror printing (**VBC**) is on (▼), messages will be printed in mirror image orientation.

## OPERATION

### TO TURN MIRROR PRINTING ON/OFF

After entering Format mode:

- (1) Press the ► key until the MIRROR PRINTING field flashes.
- (2) Press the ▲ or ▼ key until the setting you wish to use is displayed (the ▲ symbol indicates that the mirror printing function is on).
- (3) Press the RETURN key.

## EXAMPLE

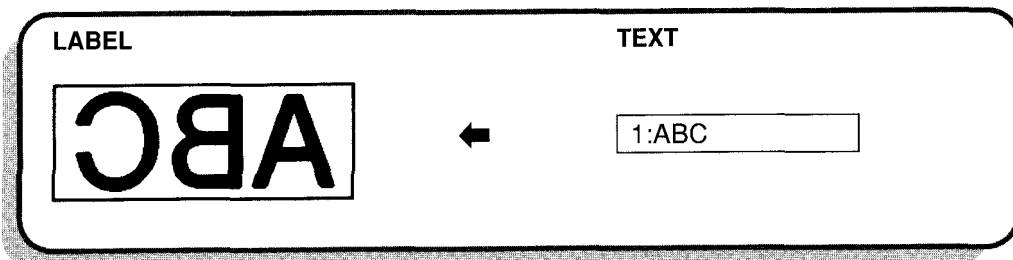

# GLOBAL FORMATS

## BACKGROUND

Every text message must be given a global format which determines the size, style and alignment of its characters. All the LCD display settings – font, size, width, style, underline, framing, length, horizontal alignment, vertical alignment, vertical printing and mirror printing – can be set as part of a global format. Furthermore, formats can be assigned before, during or after text entry. Hence, the same text file can be printed in different styles, simply by changing its format.

## OPERATION

### TO CREATE A FORMAT

(1) Press the **FORMAT** key. The upper format screen will appear (remember that there are two format screens: upper and lower).

To edit settings:

(2) Press the **▶** and **◀** keys until the first setting you wish to change is flashing.

(3) Press the **▲** or **▼** key until the setting value you wish to select is displayed.

(4) Repeat steps (2) and (3) until all settings are set as you want them.

(5) Press the **RETURN** key.

☞ *If you have created a particular format that you would like to keep, and now want to create another format based on the first one but with some modifications, store the current text and format in memory before you make the changes.*

*Refer to the "Store" section on page 72 for details.*

*To select a particular setting's default value, press the **SPACE** key.*

*To select the default values for all the global format settings, hold down the **CODE** key and press the **SPACE** key.*



EXAMPLE

FONT SIZE WIDTH STYLE A A

A A T M N O R M .

A U T L E F T B T M

LENGTH HORIZONTAL VERTICAL ALIGNMENT A B VBC

AXZ Corporation  
Main Street  
Fairtown, OH



FONT SIZE WIDTH STYLE A A

B 1 0 M I + B L D

4 . 0 C T R B T M

LENGTH HORIZONTAL VERTICAL ALIGNMENT A B VBC

*AXZ Corporation  
Main Street  
Fairtown, OH*

# LOCAL FORMATS

## BACKGROUND

Unlike the global format, local formats are purely optional. A global format is made up of general settings which can apply to all characters in the label. A local format consists of settings which apply only to selected groups of characters, and which override the global format settings. Local formats enable you to emphasize a group of characters, word or group of words within your message. Only the items on the upper global format screen – font, size, width, style, underlining, and framing – can be set as part of a local format. Local formats can be assigned during or after text entry. You can create, edit and cancel local formats as follows:

- ✎ *Numbering ranges and bar codes cannot include an incomplete portion of a locally formatted field.*

## OPERATION

### TO CREATE A LOCAL FORMAT

- (1) Position the cursor under the first character to which you want to assign the local format.
- (2) Press the **LOCAL FORMAT** key. The character will start to flash.
- (3) Move the cursor until all the characters to which you want to assign the local format are flashing.
- (4) Press the **RETURN** key. The local format screen will appear.
- (5) Press the **▶** and **◀** keys until the first setting you wish to change is flashing.
- (6) Press the **▲** or **▼** key until the setting you want is displayed.
- (7) Repeat steps (5) and (6) until all settings are as you want them.
- (8) Press the **RETURN** key. The format is applied to the selected characters and the LCD display returns to Text entry mode.

### TO EDIT A LOCAL FORMAT

- (1) Position the cursor within the local format field.
- (2) Press the **LOCAL FORMAT** key. The local format screen will appear.
- (3) Press the **▶** and **◀** keys until the first setting you wish to change is flashing.
- (4) Press the **▲** or **▼** key until the setting you want is displayed.
- (5) Repeat steps (3) and (4) until all settings are as you want them.
- (6) Press the **RETURN** key. The new local format is applied to the selected characters and the LCD display returns to Text entry mode.

### TO CANCEL A LOCAL FORMAT

- (1) Position the cursor to the right of either of the two local format marks in the text.
- (2) Press the **BS** key.
- (3) A message, "OK TO CLEAR?", appears on the display. Press the **RETURN** key to cancel the local format (or **CANCEL** to leave the local format unchanged).
- (4) The local format is cancelled and the local format marks disappear from your text file.

 To select a particular setting's default value, press the **SPACE** key.  
To select the default values for all the local format settings, hold down the **CODE** key and press the **SPACE** key.

### EXAMPLE

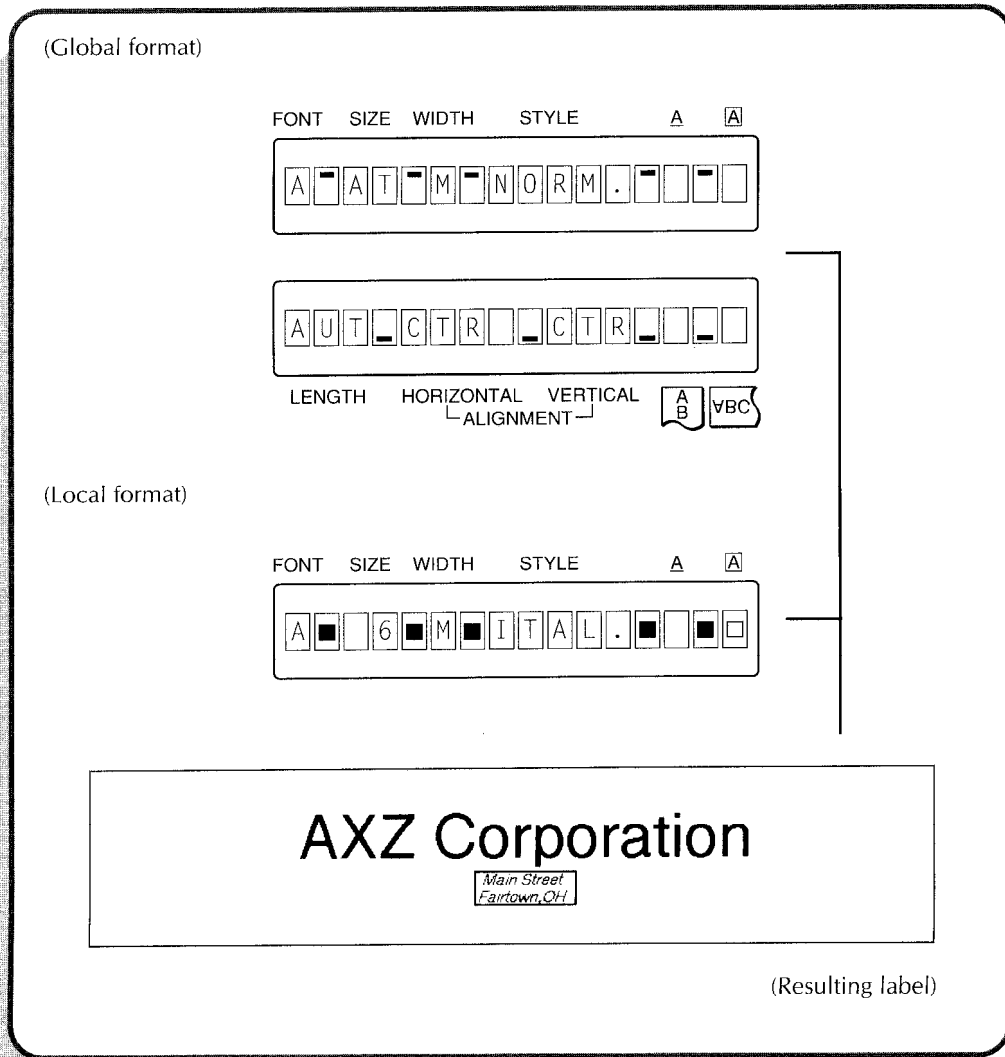

# STORE

## BACKGROUND

The phrase memory Store function can be used to save frequently used text messages and their formats. Once saved, your messages will then remain available for recall, even if you clear the working area by pressing the **CODE** and **CLEAR** keys (provided that you don't delete the memory file using the Delete function).

When stored, each message file is assigned an individual file number to facilitate recall. If the P-TOUCH's phrase memory gets full, future attempts to store label messages will cause the error message "MEMORY FULL!" to appear. If this happens, you can simply overwrite an unwanted file with the current message. Alternatively, you could first delete an unwanted file and then store the current message.

## OPERATION

### TO STORE A TEXT FILE FOR FUTURE USE

- (1) Hold down the **CODE** key and press the **STORE** key.
- (2) Select a file number using the ▲ or ▼ key (the lowest unused number will appear automatically - change the number if you want to overwrite an existing file).
  - ☞ *To increase or decrease the file number by ten instead of one, hold down the **SHIFT** key and press the ▲ or ▼ key.*
  - To review the contents of the message, scroll through it using the ► and ◀ keys.*
- (3) Press the **RETURN** key. The file is saved and can be recalled for use at any time.
  - ☞ *When you try to save a file using the same file number as that of an existing file, the following message appears:*  
*"OK TO OVERWRITE?"*  
*If "Yes", press the **RETURN** key.*  
*If "No", press the **CANCEL** key.*

# RECALL

## BACKGROUND

Recall lets you bring a copy of a stored text file into the working area, so that you can print it or edit it. Recalling a file does not remove it from the phrase memory: rather, a copy of the file is copied into the working area. Hence, you can recall a file any number of times without losing it. The only way to get rid of a saved file is to delete it using the Delete function.

If there is already text in the working area when you recall a file, you must choose whether to replace the existing working area text with the stored file, or combine the two.

## OPERATION

### TO RECALL A FILE FROM THE PHRASE MEMORY

(1) Hold down the **CODE** key and press the **RECALL** key. The file number and first few characters of the most recently stored or recalled file are displayed.

(2) Press the ▲ or ▼ key until the file you want to recall is displayed.

 *To scroll through the file numbers ten at a time, hold down the **SHIFT** key and press the ▲ or ▼ key.*

*To review the contents of the file, scroll through it using the ► and ◀ keys.*

(3) Press the **RETURN** key.

 *If there is no text in the working area, the file that you selected is now recalled. If there was some text in the working area, you will now be asked whether you wish to join the existing working area text and the recalled file's text.*

*To replace the working area text with the recalled file, proceed as follows:*

(4) Press the ▲ or ▼ key until "OFF" is displayed in the "JOINING" selection area.

(5) Press the **RETURN** key. The stored text file is recalled, overwriting the existing message in the working area.

 *If you want to join the two pieces of text (the recalled file and the text currently in the working area), select "JOINING ON" in step (4) above. The recalled file's text will be inserted before the cursor.*

*New Block marks will be added before and after the recalled text.*

**EXAMPLE**

1:John Smith

- Press  + .

MEMORY RECALL (briefly)



[3] Meeting Room The most recently stored file

- Press  or  until the file # of the file you want to recall is displayed.

[1] 27 Main Road

- Press  to select "OFF" in the "JOINING" selection area.

JOINING OFF

- Press .

1:27 Main Road

## M. DELETE

### BACKGROUND

Sometimes stored label messages are no longer needed. Accordingly, you can erase text files from the P-TOUCH's phrase memory using the Delete function. There are three deletion operations which you can perform: delete a single file, delete several files and delete all stored files at once.

### OPERATION

#### TO DELETE A SINGLE FILE FROM THE PHRASE MEMORY

- (1) Hold down the **CODE** key and press the **M.DEL** key.
- (2) Press the **▲** or **▼** key until the file you want to delete is displayed.
- (3) Press the **RETURN** key. The message "OK TO DELETE?" will be displayed.
- (4) To delete the file, press the **RETURN** key again.  
If you change your mind and decide not to delete the file, press the **CANCEL** key.

#### TO DELETE SEVERAL FILES FROM THE PHRASE MEMORY

- (1) Hold down the **CODE** key and press the **M.DEL** key.
- (2) Press the **▲** or **▼** key until one of the files you want to delete is displayed.
- (3) Press the **SPACE** key to select the file for deletion. The file number and the first few characters flash.  
Continue selecting files for deletion by repeating steps (2) and (3).
- (4) When you have selected all the files that you want to delete, press the **RETURN** key. The message "OK TO DELETE?" will be displayed.
- (5) Press the **RETURN** key to delete the selected files.

 *If you change your mind and decide not to delete the files, press the **CANCEL** key instead. The most recently selected file is displayed and the screen flashes.*

*You can now either deselect some files before deleting the rest, deselect all files and start selecting from scratch again, or abandon deletion altogether.*

*If you want to delete some but not all of the selected files, select the files you wish to retain as follows: press the **▲** or **▼** key until a selected file that you want to keep is displayed and press the **SPACE** key so that the file name stops flashing. Repeat this process for each file that you want to keep, then press the **RETURN** key to delete.*

*To deselect all selected files, hold down the **CODE** key and press the **CLEAR** key. The display stops flashing and no files are selected. Now you can start selecting files from scratch again.*

*Alternatively, press the **CANCEL** key to abandon deletion completely and return the display to Text entry mode.*

**TO DELETE ALL THE FILES FROM THE PHRASE MEMORY**

- (1) Hold down the **CODE** key and press the **M.DEL** key.
- (2) Hold down the **CODE** key and press the **SPACE** key.
- (3) Press the **RETURN** key.
- (4) The message, "DELETE ALL MEM.?" will be displayed.
- (5) Press the **RETURN** key to delete all the files in memory.

 *To delete selected files only or abandon deletion altogether, refer to the note attached to step 5 on the previous page.*



## PRINTING & TAPE FEED

### BACKGROUND

The **PRINT** key allows you to print the text you have created onto a tape. The text appears in the format which you have selected. In Print mode, five different parameters may be set.

PARAMETER	POSSIBLE SETTINGS
Tape feed _____	FULL(1"), MEDIUM(1/2"), NARROW(1/3"), NONE(1/6")
Copies _____	1 to 99
Numbering increases _____	OFF, 1 to 99
Cut pause _____	ON, OFF
Density _____	NORMAL, +1, +2, -2, -1

**TAPE FEED** The P-TOUCH automatically leaves equal margins on the left and right sides of a label. You can choose whether to have "FULL" margins (1"), "MEDIUM" margins (1/2"), "NARROW" margins (1/3"), or "NONE" (1/6").

When a single label or a set of labels is printed, the P-Touch always feeds out 1" of tape before the first letter of the first label. Hence, if "FULL" tape feed is not selected, there will be excess tape (either 1/2", 2/3" or 5/6") to the left of the first label's left margin. You can cut off this excess so that the text on the label is correctly aligned by turning on the "CUT PAUSE" function. See below for an explanation of this feature.

When messages include bar codes, full tape feed is recommended. Reducing the tape feed may decrease bar code readability.

**COPIES** The "COPIES" setting determines how many copies of the current label will be printed. When the text includes a numbering field, this setting determines how many copies will be printed for each numbering field value.

**NUMBERING INCREASES** This setting determines the number of times in the printing session that the numbering field, if there is one, will be incremented (increased by 1). See the section entitled "Sequential numbering" on page 43.

**CUT PAUSE** When a label is printed, 1" of tape is fed out before the first character of the label is printed.

Hence, if "TAPE FEED" is set to "NONE", "NARROW" or "MEDIUM", excess tape is produced (that is, there is more space to the left of the text than there is to the right). If "TAPE FEED" is set to "FULL", no excess tape is generated, as both margins are 1".

When several labels are printed using either the "NONE", "NARROW" or "MEDIUM" margin setting, excess tape is only produced before the first label of the series.

If you are printing out a single label using either the "NONE", "NARROW" or "MEDIUM" margin setting, or printing out several labels at any margin setting, it is recommended that you set "CUT PAUSE" to "ON".

When "CUT PAUSE" is "ON" and you print out more than one label using either the "COPIES" setting or the numbering "INCREASES" setting, before the first label is printed you will be prompted to cut off the excess tape with the message "CUT NOW". Cut off the excess tape with the cutter lever. Thereafter, each time a label has been printed, "CUT NOW" will appear again. Press the cutter lever to cut off each new label. After you have cut the tape, each new label is automatically printed so that the portions of blank tape before and after the label's message are both equal to the "TAPE FEED" margin setting.

If you set "CUT PAUSE" to "OFF", the labels will be printed on a continuous strip of tape. When printing has finished, you will have to cut the tape into individual labels with a pair of scissors.

**DENSITY** The print density is a measure of the number of dots per square inch that make up the printed characters on the tape. In practice, this affects how light or dark the printed output will appear. The density is usually set to "NORMAL" but can be adjusted to make the label text lighter or darker. "2" is the darkest setting, and "-2" the lightest.

## OPERATION

### TO PRINT A LABEL

- (1) Press the **PRINT** key. The print settings selection menu will appear.
- (2) If the default settings are the settings that you want (see "Example"), press the **RETURN** key.

To edit the print settings:

- (3) Press the **▶** and **◀** keys until the first setting you wish to change flashes.
  - (4) Press the **▲** or **▼** key until the setting value you wish to use is displayed.
-  *If you do not want to use the numbering feature, select "OFF" simply by pressing the **SPACE** key; this saves you having to scroll through all the "INCREASES" choices.*
- (5) Repeat steps (3) and (4) until all setting values are set as you want them.
  - (6) Press the **RETURN** key. Your labels are printed according to the print parameters that you have set.

 *If "CUT PAUSE" is set to "OFF", do not press the cutter lever while the P-TOUCH is printing.*

*If you decide to cancel printing half way through, press the **CANCEL** key, then press the **FEED** key to feed out the remainder of the partially printed label. Finally, press the cutter lever to cut off the tape.*

**EXAMPLE**

(Text message)

1: ABCFN1N\_

**Default Print Settings**

Tape Feed:	FULL
Copies:	1
Numbering Increases:	OFF
Cut Pause:	ON
Density:	NORMAL

ABC1  
1" 1"

**Custom Print Settings**

Tape Feed:	NONE
Copies:	2
Numbering Increases:	3
Cut Pause:	OFF
Density:	NORMAL

ABC1 ABC1 ABC2 ABC2 ABC3 ABC3  
1" 1/3" 1/3" 1/3" 1/3" 1/3" 1/6"

↓ When "CUT PAUSE" is set to "ON".

ABC1 ABC1 ABC2 ABC2 ABC3 ABC3  
excess 1/6" 1/6" 1/6" 1/6" 1/6" 1/6" 1/6" 1/6"

# BAR CODING

## BACKGROUND

The bar coding function is one of the P-TOUCH's most advanced features. Your P-TOUCH is able to print a bar code as part of a label.

 This section will explain the P-TOUCH's bar coding feature and tell you how to insert bar codes into your text messages. It is not, however, intended as a comprehensive introduction to the topic of bar coding. If you need this, please consult one of the many reference books available.

*Since this machine is not designed for special bar code label making, some bar code readers may not be able to read the labels that it produces.*

Please use black characters on white tape for bar code labels.

When setting a parameter, you can simply press the **SPACE** key to select the parameter's default value. This saves your having to scroll through all the possible choices.

We recommend that you print bar codes at either "M" (MEDIUM) or "L" (LARGE) width, using "FULL" tape feed.

If "TAPE FEED" is set to anything other than "FULL", or if "S" (SMALL) width is selected, the resulting bar codes may not be readable.

When you enter a message consisting only of letters and numbers, the maximum message height is 96 dots plus the size of any frame. However, a message containing a bar code has a maximum height of 72 dots.

In Bar code mode, six different parameters may be set.

PARAMETER	POSSIBLE SETTINGS
Protocols (PROTO:) —————	CODE 39, I-2/5, EAN13, EAN8, UPC-A, UPC-E, CODABAR, EAN 128, CODE 128, ISBN 5, ISBN 2
Bar code width (WIDTH:) ———	MEDIUM, SMALL, LARGE
Characters printed below Bar code (UNDER # S:) ———	ON, OFF
# of characters in code (# OF CHARS:) —————	AUTO, 4 to 22
Ratio (RATIO:) —————	3:1, 2.5:1, 2:1
Check digit (CHECK DIG.) —	OFF, ON

## OPERATION

### TO ENTER A BAR CODE INTO YOUR MESSAGE

- (1) Hold down the **CODE** key and press the **BAR CODE** key. The most recently entered bar code's protocol will be displayed briefly.
- (2) The bar code data input screen now appears. Check the bar code's settings as follows, and, if necessary, edit them:

 *If you set the check digit, change the protocol or set the number of characters in the bar code, check that these settings are appropriate before you enter the bar code data. Change them if necessary. If you forget to check the settings before entering the bar code data, it is sometimes possible to check them afterwards.*

- (3) Press the **FORMAT** key.
- (4) Press the **▶** and **◀** keys until the first setting you wish to change is flashing.
- (5) Press the **▲** or **▼** key until the setting value you wish to select is displayed.
- (6) Repeat steps (4) and (5) until all settings are set as you want them.
- (7) Press the **RETURN** key.
- (8) Type in your bar code.
- (9) When you have finished, press the **RETURN** key.

## EXAMPLE

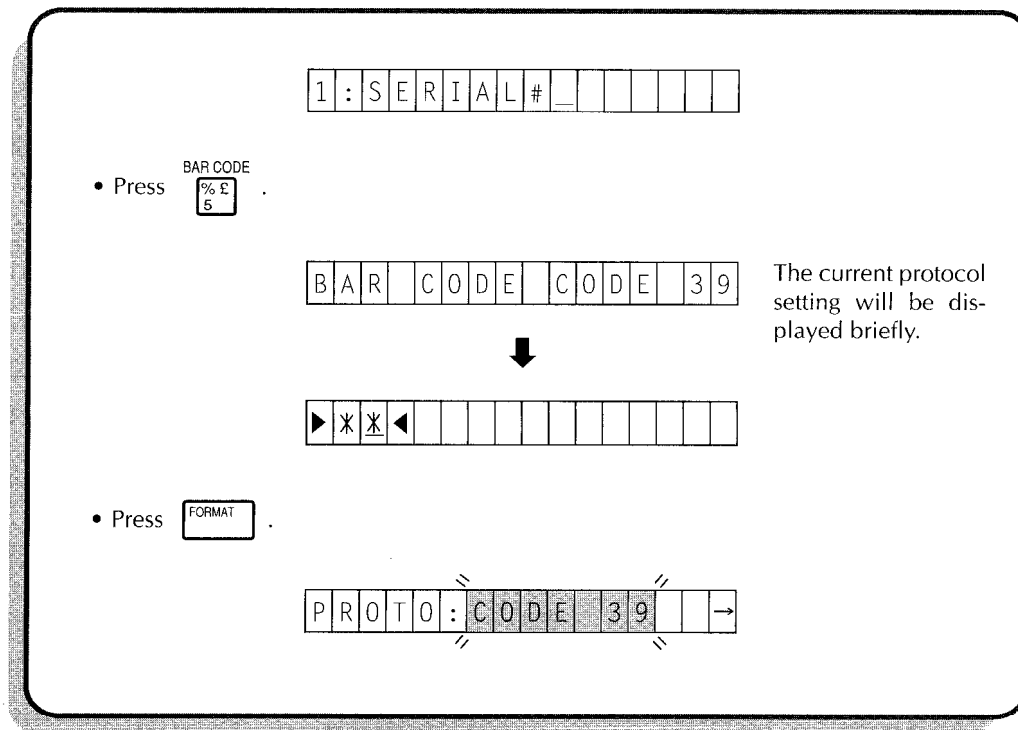

- Press  until the "WIDTH" setting flashes.

← W I D T H : M E D I U M →

- Press  or  until LARGE flashes.

← W I D T H : L A R G E →

- Press .

▶ \* \* ◀

- Enter bar code data ("123456").

▶ \* 1 2 3 4 5 6 \* ◀

- Press .

1 : S E R I A L # ◀ ||| \_

# ENTERING DATA USING SPECIAL (NON-KEYBOARD) CHARACTERS

## BACKGROUND

When either CODE128 or EAN128 bar code protocol is selected, you can enter bar code data using any of the 128 ASCII characters. These are made up of the characters shown on the key tops plus the following:

VALUE 28	<	VALUE 74	LF	VALUE 88	CAN
VALUE 30	>	VALUE 75	VT	VALUE 89	EM
VALUE 60	\	VALUE 76	FF	VALUE 90	SUB
VALUE 63	_	VALUE 77	CR	VALUE 91	ESC
VALUE 64	NUL	VALUE 78	SO	VALUE 92	FS
VALUE 65	SOH	VALUE 79	SI	VALUE 92	I
VALUE 66	STX	VALUE 80	DLE	VALUE 93	GS
VALUE 67	ETX	VALUE 81	DC1	VALUE 94	RS
VALUE 68	EOT	VALUE 82	DC2	VALUE 95	US
VALUE 69	ENQ	VALUE 83	DC3	VALUE 95	DEL
VALUE 70	ACK	VALUE 84	DC4	VALUE 96	FNC 3
VALUE 71	BEL	VALUE 85	NAK	VALUE 97	FNC 2
VALUE 72	BS	VALUE 86	SYN	VALUE 100	FNC 4
VALUE 73	HT	VALUE 87	ETB	VALUE 102	FNC 1

## OPERATION

### ENTERING DATA FOR CODE128 OR EAN128 BAR CODES USING NON-KEYBOARD CHARACTERS

- (1) Hold down the **CODE** key and press the **BAR CODE** key. The bar code data input screen appears.
- (2) When you enter the bar code data, position the cursor at the point at which you want to enter the non-keyboard character, then hold down the **CODE** key and press the **SYMBOL** key.
- (3) Press the **▲** or **▼** key until the character you wish to use is flashing.
- (4) Press the **RETURN** key. The display returns to the bar code information input screen and the character data is added to the bar code. On the screen a square box (□) appears in the bar code in the place where you entered the special character (unless it is '<', '>', '\', '\_' or '|', in which case the character itself appears).

 The diagrams below show what appears below the bar code when you insert a special character other than '<', '>', '\', '\_' or '|', and what appears when you insert a '>'.



**EXAMPLE**

1 : E Q U I P M E N T # \_ \_ \_ \_

- Press  +  .

▶ ◀ | | | | | | | | | | | | | |

- Enter bar code data.

▶ 1 2 3 4 5 6 ◀ | | | | | | | | | |

- Press  +  .

V A L U E 2 8 < | | | | | | | | | |

- Press  once.

V A L U E 3 0 > | | | | | | | | | |

- Press  .

▶ 1 2 3 4 5 6 > ◀ | | | | | | | | | |

 *These special symbols are only available if you have selected CODE128 or EAN128 bar code protocol.*

You can also automatically number bar codes; this is useful for generating serial number labels. Refer to "Sequential numbering" on page 43.



# USING THE TAPE SEPARATOR/LETTERING STICK

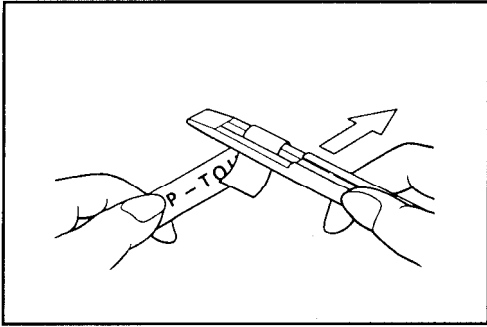
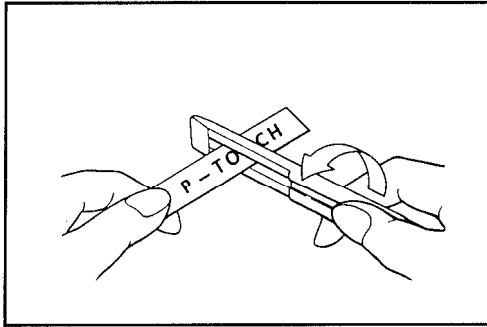

## HOW TO REMOVE LABEL BACKING

The supplied stick enables the label backing of the tape to be removed easily.

- (1) Hold the tape in your left hand, with the printed surface facing up, and the stick in your right hand.
- (2) Pass the tape halfway through the long narrow hole of the stick.
- (3) Turn the stick counterclockwise half a turn and pull the stick to the right.

## INSTANT LETTERING TAPE (RUB-ON CHARACTERS)

Instant lettering tapes act as rub-on character transfers. After creating a message, simply position the characters over a sheet of paper. By rubbing the instant lettering tape's non-printed side with the supplied stick, you can transfer the tape's contents directly onto the paper.

**Caution:** Hold the tape very firmly and do not move it as you rub it.

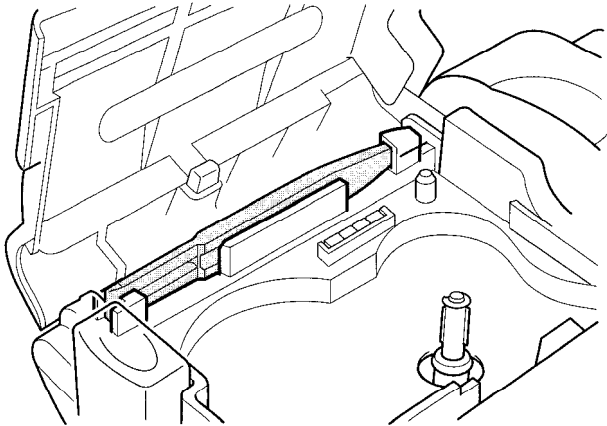

## MESSAGE LIST

MESSAGE	MEANING	TO DO
1-FIELD LIMIT!	<ul style="list-style-type: none"> <li>Only one numbering field may be created per label. If one already exists and you try to create another, this message will appear.</li> </ul>	<ul style="list-style-type: none"> <li>Either delete the existing numbering field or stop trying to create a new one.</li> </ul>
4-DIGIT MIN.	<ul style="list-style-type: none"> <li>Bar code data must consist of at least four digits. If you enter fewer than four digits and press the <b>RETURN</b> key, this message will appear.</li> </ul>	<ul style="list-style-type: none"> <li>Enter four or more digits</li> </ul>
5-LINE LIMIT!	<ul style="list-style-type: none"> <li>Each block of text in a label can contain no more than five lines. If a block already contains five lines and you press the <b>RETURN</b> key, this message will appear.</li> <li>If you try to delete a block return mark in such a way that a block of six lines or more would result, this message will appear.</li> </ul>	<ul style="list-style-type: none"> <li>Do not press the <b>RETURN</b> key. Limit the number of lines in the current block to five.</li> <li>Do not attempt to delete the mark. Adjust the total number of lines in each block so that no block will have more than five lines.</li> </ul>
10-BLOCK LIMIT!	<ul style="list-style-type: none"> <li>Each label can contain no more than ten blocks. If a label contains ten blocks and you press the <b>NEW BLOCK</b> key, this message will appear.</li> </ul>	<ul style="list-style-type: none"> <li>Do not press the <b>NEW BLOCK</b> key. Limit the number of blocks in the file to ten.</li> </ul>
10-CHR. LIMIT!	<ul style="list-style-type: none"> <li>Each numbering field can contain no more than ten letters or digits. If a numbering field already contains ten letters or digits and you try to insert another character, hidden character, blank space or symbol, this message will appear.</li> <li>Also, if you highlight more than ten characters while using the cursor to select a numbering field, and then press the <b>RETURN</b> key, this message will appear.</li> </ul>	<ul style="list-style-type: none"> <li>Do not enter the character. Limit the number of characters in the numbering field to ten.</li> <li>Do not attempt to select more than ten characters.</li> </ul>
ABCD AT BEG & END	<ul style="list-style-type: none"> <li>When you select the CODABAR bar code format, you must enter a letter (A, B, C or D) at the start of the numbering field and another letter (also A, B, C or D) at the end of the numbering field. If you press the <b>RETURN</b> key without entering both these two letters, this message will appear.</li> </ul>	<ul style="list-style-type: none"> <li>Enter A, B, C or D at the start of the bar code and A, B, C or D at the end.</li> </ul>
BAD 「 F F 」 CONTENTS!	<ul style="list-style-type: none"> <li>A local format field must include some text. If the cursor is positioned under a bar code or numbering mark and you press the <b>LOCAL FORMAT</b> key and then the <b>RETURN</b> key without selecting any text, this message will appear.</li> </ul>	<ul style="list-style-type: none"> <li>Select some text or press any key to return to Select field mode.</li> </ul>
BATTERIES EMPTY!	<ul style="list-style-type: none"> <li>This message appears when the batteries are dead.</li> </ul>	<ul style="list-style-type: none"> <li>Replace the batteries or use the optional AC adaptor instead.</li> </ul>

MESSAGE	MEANING	TO DO
BATTERIES WEAK!	<ul style="list-style-type: none"> <li>If you are running the P-TOUCH off batteries, this message will appear when the batteries are running out.</li> </ul>	<ul style="list-style-type: none"> <li>Replace the batteries or use the optional AC adaptor instead.</li> </ul>
BUFFER EMPTY!	<ul style="list-style-type: none"> <li>If you try to print, but have not input any text into the working area, this message will appear.</li> <li>If you try to store a text file, but have not input any text into the working area, this message will appear.</li> <li>If you press the <b>CODE</b> and <b>SEQUENTIAL NUMBERING</b> keys or the <b>LOCAL FORMAT</b> key when there is no data in the working area, this message will appear.</li> </ul>	<ul style="list-style-type: none"> <li>Enter text and then print.</li> <li>Enter text and then store the file.</li> <li>Enter some text and then automatically number or locally format it.</li> </ul>
BUFFER FULL!	<ul style="list-style-type: none"> <li>There is a limit on how much text can be entered into the working area. When you try to enter a character, hidden character, RETURN, NEW BLOCK or space that would cause this limit to be exceeded, this message will appear.</li> <li>If pressing the <b>RETURN</b> key in Numbering mode, Symbol mode, Local format mode, or Bar code mode would cause this limit to be exceeded, this message will appear.</li> <li>If pressing the <b>RETURN</b> key to recall a file and join it to the text in the working area would cause this limit to be exceeded, this message will appear.</li> </ul>	<ul style="list-style-type: none"> <li>You cannot add any more text to this label. Delete some of the existing text so that more text may be entered.</li> <li>Press any key to return to Text entry mode. Delete some of the existing text before re-trying any of these operations.</li> <li>Press any key to return to Text entry mode and delete some of the existing text before recalling the file, or recall the file to overwrite the working area text (turn the joining function "OFF").</li> </ul>
CAN'T DO HERE!	<ul style="list-style-type: none"> <li>When the cursor is positioned in a numbering field or bar code field, you cannot recall a stored text file and join it to the working area text at that point in the text. If you attempt to, this message will appear.</li> <li>If you try to enter a bar code into a numbering field that already contains numbers and/or letters, this message will appear.</li> <li>If, after entering a bar code into the numbering field, you attempt to input numbers, letters or another bar code, this message will appear.</li> </ul>	<ul style="list-style-type: none"> <li>Move the cursor out of the field or delete the field before recalling the stored file.</li> <li>Stop trying to enter a bar code into the numbering field. A numbering field can only contain either numbers and/or letters or a bar code.</li> <li>Stop entering numbers or characters into the numbering field. A numbering field can only contain either numbers and/or letters or a bar code.</li> </ul>
CAN'T ENTER AT	<ul style="list-style-type: none"> <li>When the cursor is positioned under a bar code mark, no character, hidden character, symbol or space may be entered. If you try to enter any of these, this message will appear.</li> </ul>	<ul style="list-style-type: none"> <li>Move the cursor or stop trying to enter the character.</li> </ul>
CODE TOO LONG!	<ul style="list-style-type: none"> <li>If you try to enter a bar code whose length exceeds the maximum length limit, this message will appear when you press the <b>RETURN</b> key.</li> </ul>	<ol style="list-style-type: none"> <li>Change the bar code width and ratio settings.</li> <li>Enter less data into the bar code.</li> <li>Change to a bar code protocol other than CODE 39, CODE 128 or EAN128, as errors often occur in these formats.</li> </ol>

MESSAGE	MEANING	TO DO
DELETE ALL MEM.?	<ul style="list-style-type: none"> <li>If you try to delete all files stored on the machine, this message will appear.</li> </ul>	<ul style="list-style-type: none"> <li>If you want to delete all the stored files press the <b>RETURN</b> key. If not, press the <b>CANCEL</b> key.</li> </ul>
INPUT WHOLE CODE	<ul style="list-style-type: none"> <li>In Bar code mode you sometimes set the number of digits that are to be typed in for the bar code. If you do not enter that number of digits when you input the bar code data, this message will appear.</li> </ul>	<ul style="list-style-type: none"> <li>Enter the correct number of digits, or change the bar code's "#OF CHRS" setting.</li> </ul>
MEMORY FULL!	<ul style="list-style-type: none"> <li>The P-TOUCH can store a maximum of about 2000 characters in its memory. If you try to store a file which would cause this limit to be exceeded, this message will appear.</li> </ul>	<ul style="list-style-type: none"> <li>Do not store the text file, or delete an old file that is no longer needed, to make room for the new one.</li> </ul>
NO ↓ AT    !	<ul style="list-style-type: none"> <li>Bar code fields must lie completely on a single line. If the cursor is positioned in the bar code field and you press the <b>RETURN</b> key, this message will appear.</li> </ul>	<ul style="list-style-type: none"> <li>Move the cursor or stop trying to enter a RETURN mark.</li> </ul>
NO ↓ IN 「N N」!	<ul style="list-style-type: none"> <li>Numbering fields must lie completely on a single line. If the cursor is positioned in the numbering field and you press the <b>RETURN</b> key, this message will appear.</li> </ul>	<ul style="list-style-type: none"> <li>Move the cursor or stop trying to enter a RETURN mark.</li> </ul>
NO ▣ AT    !	<ul style="list-style-type: none"> <li>Bar code fields must lie completely within a single block. If the cursor is positioned in the bar code field and you press the <b>NEW BLOCK</b> key, this message will appear.</li> </ul>	<ul style="list-style-type: none"> <li>Move the cursor or stop trying to enter a BLOCK RETURN mark.</li> </ul>
NO ▣ IN 「N N」!	<ul style="list-style-type: none"> <li>Numbering fields must lie completely within a single block. If the cursor is positioned in the numbering field and you press the <b>NEW BLOCK</b> key, this message will appear.</li> </ul>	<ul style="list-style-type: none"> <li>Move the cursor or stop trying to enter a BLOCK RETURN mark.</li> </ul>
NO ↓ / ▣ IN 「N N」!	<ul style="list-style-type: none"> <li>Numbering fields must lie completely within a single line of a single block. When you use the cursor to select characters for the numbering field and you try to include a RETURN or BLOCK RETURN mark, this message will appear.</li> <li>When the cursor is positioned under a RETURN or BLOCK RETURN mark and you hold down the <b>CODE</b> key and press the <b>SEQUENTIAL NUMBERING</b> key, this message will appear.</li> </ul>	<ul style="list-style-type: none"> <li>Do not try to include any RETURN or BLOCK RETURN marks in the numbering field. Move the cursor and try again.</li> <li>The numbering field must lie entirely on a single line. Do not try to include any RETURN or BLOCK RETURN marks in the numbering field.</li> </ul>
NO ◀     IN 「N N」!	<ul style="list-style-type: none"> <li>If you try to include a bar code in the numbering field together with other types of data, such as alphanumeric characters, hidden characters, blanks, spaces or symbols, this message will appear.</li> <li>If you are using the ▶ and ◀ keys to select characters for the numbering field and you try to include a bar code mark, this message will appear.</li> </ul>	<ul style="list-style-type: none"> <li>Do not include a bar code.</li> <li>If you want the bar code to number automatically, first position the cursor under the ◀    mark, then hold down the <b>CODE</b> key and press the <b>SEQUENTIAL NUMBERING</b> key.</li> </ul>

MESSAGE	MEANING	TO DO
NO 「F F」 IN 「N N」!	<ul style="list-style-type: none"> <li>• A local format field cannot overlap a numbering field. This message will appear when:</li> <li>• The cursor is positioned at a local format mark and you hold down the <b>CODE</b> key and press the <b>SEQUENTIAL NUMBERING</b> key, or</li> <li>• The cursor is positioned in a numbering field and you press the <b>LOCAL FORMAT</b> key, or</li> <li>• You are using the <b>▶</b> and <b>◀</b> keys to select characters for a local format field and you try to include only part of a numbering field (the entire numbering field with both of its marks must be included), or you overlap the numbering field with a locally formatted field and press the <b>RETURN</b> key.</li> </ul>	<ul style="list-style-type: none"> <li>• Do not attempt to overlap numbering fields and local format fields.</li> <li>• Move the cursor or stop trying to enter these marks.</li> <li>• Include the entire numbering field within the local format or stop trying to include any part of the numbering field in the local format field.</li> <li>• Do not use local formatting or do not try to automatically number a field of text lying only partly within the local format.</li> </ul>
NO 「F F」 OVERLAP!	<ul style="list-style-type: none"> <li>• Although several local format fields may be created within a single label, they may not overlap. In other words, the same character cannot be included in more than one local format field. When you use the cursor to select characters for a local format field and you try to include an existing local format mark, this message will appear.</li> </ul>	<ul style="list-style-type: none"> <li>• Do not attempt to include text that lies within an existing local format in a new local format field.</li> </ul>
NO CASSETTE!	<ul style="list-style-type: none"> <li>• If you attempt to print a label or feed tape when there is no cassette in the machine, this message will appear.</li> </ul>	<ul style="list-style-type: none"> <li>• Insert a tape cassette and re-try.</li> </ul>
NO TEXT FILES!	<ul style="list-style-type: none"> <li>• If you try to recall or delete a text file from memory when none is stored in memory, this message will appear.</li> </ul>	<ul style="list-style-type: none"> <li>• Stop trying to recall or delete a file.</li> </ul>
OK TO CLEAR?	<ul style="list-style-type: none"> <li>• When you hold down the <b>CODE</b> key and press the <b>CLEAR</b> key, this confirmation message will appear.</li> </ul>	<ul style="list-style-type: none"> <li>• If you want to clear all text from the working area, press the <b>RETURN</b> key. If not, press the <b>CANCEL</b> key.</li> </ul>
OK TO CLEAR ◀   ?	<ul style="list-style-type: none"> <li>• When you try to delete a bar code mark, this confirmation message will appear.</li> </ul>	<ul style="list-style-type: none"> <li>• If you want to delete the bar code information, press the <b>RETURN</b> key. If not, press the <b>CANCEL</b> key.</li> </ul>
OK TO CLEAR 「F F」?	<ul style="list-style-type: none"> <li>• When you try to delete a local format mark, this confirmation message will appear.</li> </ul>	<ul style="list-style-type: none"> <li>• If you want to delete the local format, press the <b>RETURN</b> key (text within the field will not be affected). If not, press the <b>CANCEL</b> key.</li> </ul>
OK TO CLEAR 「N N」?	<ul style="list-style-type: none"> <li>• When you try to delete a numbering field mark, this confirmation message will appear.</li> </ul>	<ul style="list-style-type: none"> <li>• If you want to delete the numbering field, press the <b>RETURN</b> key (text within the field will not be affected). If not, press the <b>CANCEL</b> key.</li> </ul>
OK TO DELETE?	<ul style="list-style-type: none"> <li>• When you try to delete one or more text files from the machine's memory, this confirmation message will appear.</li> </ul>	<ul style="list-style-type: none"> <li>• If you want to delete the file or files, press the <b>RETURN</b> key. If not, press the <b>CANCEL</b> key.</li> </ul>

MESSAGE	MEANING	TO DO
OK TO OVERWRITE?	<ul style="list-style-type: none"> <li>If you are trying to store a file in memory and select the number of an existing file, this message will appear when you press the <b>RETURN</b> key.</li> </ul>	<ul style="list-style-type: none"> <li>If you want to replace the file (overwriting it in the memory), press the <b>RETURN</b> key. If not, press the <b>CANCEL</b> key.</li> </ul>
RAM DOWN!	<ul style="list-style-type: none"> <li>If there is a problem with the machine's random access memory, this message will appear.</li> </ul>	<ul style="list-style-type: none"> <li>Contact your service representative.</li> </ul>
RELOCATE CURSOR!	<ul style="list-style-type: none"> <li>If the cursor is positioned one place past the end of the text message and you press the <b>LOCAL FORMAT</b> key, or hold down the <b>CODE</b> key and press the <b>SEQUENTIAL NUMBERING</b> key, this message will appear.</li> </ul>	<ul style="list-style-type: none"> <li>As there is no data at or after the cursor position, move the cursor to the first character which you wish to include in the numbering or local format field.</li> </ul>
ROM DOWN!	<ul style="list-style-type: none"> <li>If there is a problem with the machine's read only memory, this message will appear.</li> </ul>	<ul style="list-style-type: none"> <li>Contact your service representative.</li> </ul>
SYSTEM ERROR!	<ul style="list-style-type: none"> <li>If there is a problem with the machine's software, this message will appear.</li> </ul>	<ul style="list-style-type: none"> <li>Contact your service representative.</li> </ul>
TEXT TOO LONG!	<ul style="list-style-type: none"> <li>In a global format you may sometimes set a length for the entire label. If the text you have entered will be too long for the selected label length, this message will appear when you try to print.</li> <li>The same problem may occur when you are using vertical printing.</li> <li>The same problem may also occur when AUTO ("AT") size is selected. If even the smallest characters would be too long for the selected label length, then this message will appear.</li> </ul>	<ul style="list-style-type: none"> <li>Reduce the character size or increase the label length setting.</li> <li>Reduce the amount of text in the message or increase the label length setting.</li> <li>Reduce the amount of text in the message or increase the label length setting.</li> </ul>
TEXT TOO WIDE!	<ul style="list-style-type: none"> <li>If you are printing text (either vertically or horizontally) and the character size which you have selected is too large to allow all of your message to be printed on the tape, this message will appear when you press the <b>RETURN</b> key.</li> </ul>	<ul style="list-style-type: none"> <li>Reduce the character size or select AUTO ("AT"). Selecting a smaller font size may still not allow you to print out all the lines in your message. In this case, reduce the character size further still, reduce the number of lines, or insert wider tape.</li> </ul>
TOO MANY LINES!	<ul style="list-style-type: none"> <li>If you attempt to print more lines (either vertically or horizontally) than the maximum number allowed for the installed tape size, this message will appear when you press the <b>RETURN</b> key.</li> </ul>	<ul style="list-style-type: none"> <li>Reduce the number of lines in your message or use wider tape.</li> </ul>
TOO MUCH TEXT!	<ul style="list-style-type: none"> <li>There is a limit to the amount of text that can be printed in a single label. If your message exceeds this limit and you try to print it, this message will appear.</li> </ul>	<ul style="list-style-type: none"> <li>Reduce the amount of text in your message, or reduce the character size, and try printing again.</li> </ul>

## TROUBLESHOOTING

PROBLEM	WHAT TO DO
1.The display remains blank after you have turned on the machine.	<ul style="list-style-type: none"> <li>• Check that the dry cell batteries are properly inserted and that they are not dead.</li> <li>• If you are using the optional AC adaptor, check that it is attached properly.</li> </ul>
2.The machine does not print, or the printed characters are blurred.	<ul style="list-style-type: none"> <li>• Check that the tape cassette has been inserted properly.</li> <li>• If the tape cassette is empty, replace it with a new one.</li> <li>• Make sure that the tape cassette cover has been closed.</li> </ul>
3.The printed characters are not formed properly.	<ul style="list-style-type: none"> <li>• The dry cell batteries may be low. Replace them, or try using the optional AC adaptor instead.</li> <li>• The print density setting may be incorrect. Try altering the setting.</li> </ul>
4.Silver tape appears.	<ul style="list-style-type: none"> <li>• You have reached the end of the tape. Replace it with a new tape.</li> </ul>

For technical and operational assistance call Customer Service at 1-901-373-6256 from 8:00a.m. to 4:30p.m. CST (Central Standard Time).

# MACHINE SPECIFICATIONS

## HARDWARE

Input Device:	KEYBOARD - 64 keys
LCD:	7 x 5 dots / 1 lines x 16 columns
Print Tape:	Pressure-sensitive, adhesive-based. 15m (50') long. 5 widths available: 6mm (1/4") 9mm (3/8") 12mm (1/2") 18mm (3/4") 24mm (1")
Power Supply:	Dry cell batteries or optional AC adaptor.
Print Head:	128 dot / 180 dpi  <i>Printable area 96 dots + framing</i>
Dimensions:	254mm (W) x 282mm (D) x 76mm (H) (10.0" (W) x 11.1" (D) x 3.0" (H))
Weight:	3.3lbs (1.5kg)
Optional Equipment:	AC adaptor (AD-8000)

## SOFTWARE

Character Size:	6 selectable sizes (6 points to 38 points) + Auto All are available in Narrow, Medium, and Wide
Character Fonts:	2 built-in typefaces
Buffer Size:	Single line 1m (3.3') or 255 characters Multi line Multi block 21cm (8.3") for each block
Memory Size:	1952 characters
Number of Characters:	220 characters
Print Styles:	Normal, Outline, Shadow1, Shadow2, Bold, Italic, Italic & Bold, Italic & Shadow1, Italic & Shadow2, Italic & Outline



## **FEATURES**

**The following features and functions are all included in your P-TOUCH:**

- Multi-line Printing (up to 5 lines)
- Multi-block Printing (up to 10 blocks)
- Text Framing
- Text Underlining
- Vertical Printing
- Mirror Printing
- Adjustable Tape Feed
- Label Length Setting
- Repeat Printing
- Numbering Function
- Numbering of Bar Codes

# INDEX

<b>A</b>		CAPS key	36
AC adaptor	10	CAPS mode	36
Accented characters		Cassette	7
entering	39	CENTER alignment	64
Alignment	52	Centering text	63
ALT key	36	Character size	
ASCII characters	83	setting automatically	55
AUT label length	62	setting manually	55
Auto power-off	34	Character size selection	68, 70
Automatic back-up	34	Character style selection	58, 68, 70
<b>B</b>		Character width	55
Bar code marks		Character width selection	56, 68, 70
deleting	49	Check digit	80, 81
Bar codes	80	Choosing options	40
ASCII characters	83	CLEAR key	51
check digit	45, 80, 81	CODABAR bar code	45
CODABAR format	45	CODE 39 bar code	45
CODE 39	25, 45	CODE 39 protocol	25
CODE128	83	CODE key	19, 37, 47
EAN128	83	CODE128	83
END code	45	Combination character styles	58
entering non-keyboard characters	83	Composite characters	
numbering	43, 44, 84	entering	39
protocol	80, 81, 83	COPIES setting	77
Batteries	9	Creating a global format	68
Blank display	91	Creating a local format	70
Block	23	Cursor	13, 35
creating	42	Cursor movement	47
Block return mark	42	CUT PAUSE setting	77, 78
Bold text style	58	<b>D</b>	
BOTTOM alignment	64	Darker text	78
Boxing	61	Delete function	73, 75
turning off	61	Deleting	
BS key	49	cancel	75
<b>C</b>		Deleting a single file	75
CANCEL key	46	Deleting all files	76
Canceling a local format	71	Deleting several files	75
Canceling file deletion	75	Deleting text	49
Capital letters		Deleting text from memory	29
entering	36	DENSITY	78

Diacritical marks			
entering		39	
<b>E</b>			
EAN128		83	
Editing a local format		70	
END code		45	
END key		35	
Ending a line		40	
Entering choices		40	
Entering text		42, 48	
Error messages		86–90	
<b>F</b>			
Font A		54	
Font B		20, 54	
Font selection		54, 68, 70	
Format creation		20	
FORMAT key		19, 53	
Formats		52	
Framing		20, 61, 68, 70	
turning off		61	
<b>G</b>			
Global format		26, 52, 53, 68	
creating		68	
Global format settings		19	
<b>H</b>			
HOME key		35	
Horizontal alignment		63, 68	
Horizontal centering		20	
<b>I</b>			
Inserting batteries		9	
Instant lettering tape		85	
Inventory			
making labels for		43	
Italic text style		58	
<b>J</b>			
Joining saved text to			
working area text		73	
Justifying text		63	
<b>K</b>			
Keytop symbols			
entering		36	
<b>L</b>			
Label			
entering text		42	
mirror image		67	
setting margins		77	
setting the number of copies		77	
Label backing			
removing		85	
Label length		68	
setting		62	
Labels			
recalling		73	
saving		72	
storing		72	
Left-justifying text		63	
Lighter text		78	
Line			
deleting		50	
LINE OUT key		50	
Local format		26, 52, 53, 70	
canceling		71	
creating		70	
editing		70	
LOCAL FORMAT key		52	
Local format marks			
deleting		49	
Lower screen settings		19	
<b>M</b>			
Making a local format		70	
Malformed characters		91	
Margins			
setting		77	
Marks			
deleting		49	
Memory		34	
Memory functions		28	
Message Memory Area		10	
Messages			
recalling		73	
saving		72	
storing		72	
Messages,		86–90	
Mirror image label		67	
Mirror printing		67, 68	
Moving the cursor		47	

<b>N</b>	
New block	
creating	42
NEW BLOCK key	24, 42
Non-keyboard characters	83
Non-keytop symbols	
entering	38
Normal text style	58
Numbering	43, 84
setting number of auto-numbered labels	77
Numbering field	43
Numbering field marks	43, 44
deleting	49
Numbering function	19
NUMBERING INCREASES setting	77
Numbering using a bar code	44
Numbering using numbers and letters	43
<b>O</b>	
On/Off key	13, 34
Orientation	52
Outline text style	58
<b>P</b>	
Power key	13, 34
Print density	78
Print head	
cleaning	8
PRINT key	77
Print mode	77
Print settings	43, 44
Printing	
appearance of silver tape	91
failure to print	91
malformed characters	91
number of copies	77
setting margins	77
setting number of auto-numbered labels	77
using CUT PAUSE setting	77, 78
Printing a label	29, 77
Protocol	81, 83
<b>R</b>	
Recalling messages	73
Recalling text from memory	28
Removing label backing	85
Replacing working area text with saved text	73
Reset	34
RETURN key	18, 40
Right-justifying text	63
Rub-on tape	85
<b>S</b>	
Saving messages	72
Selecting bold text style	58
Selecting boxing	61
Selecting character size	68, 70
Selecting character style	58, 68, 70
Selecting character width	56, 68, 70
Selecting combination character styles	58
Selecting font	54, 68, 70
Selecting framing	61, 68, 70
Selecting horizontal alignment	68
Selecting italic text style	58
Selecting label length	68
Selecting mirror printing	67, 68
Selecting normal text style	58
Selecting options	40
Selecting outline text style	58
Selecting shadow text style	58
Selecting text style	58
Selecting text width	56
Selecting typeface	54, 68, 70
Selecting underlining	60, 68, 70
Selecting vertical alignment	64, 68
Selecting vertical printing	65, 68
Sequential numbering	43
SEQUENTIAL NUMBERING key	43
Serial numbers	
making labels for	43
Setting AUT label length	62
Setting character size	
automatically	55
manually	55
Setting horizontal alignment	63
Setting label length	62
Setting tape length	62
Setting text alignment	52

Setting text orientation	52	Typeface	52
Setting text size	52	Typeface selection	54, 68, 70
Setting text typeface	52	<b>U</b>	
Shadow text style	58	Underlining	60, 68, 70
SHIFT key	36	turning off	60
Silver tape	91	Upper screen settings	19
SPACE key	14	<b>V</b>	
Storing messages	34, 72	Vertical alignment	64, 68
SYMBOL key	38	Vertical printing	65, 68
Symbol mode	38	<b>W</b>	
Symbols		Working area	73
entering	36, 38	Working area text	
<b>T</b>		joining saved text to	73
Tape		replacing with saved text	73
instant lettering	85		
Tape cassette	7		
TAPE FEED setting	77, 78		
Tape length			
setting	62		
Tape size	55		
Text			
deleting	49		
deleting all	51		
recalling	73		
saving	72		
storing	72		
Text alignment	52		
Text block			
creating	42		
Text entry mode	46, 48		
Text orientation	52		
Text size	52		
setting automatically	55		
setting manually	55		
Text style			
selecting	58		
Text typeface	52		
Text width	55		
selecting	56		
TOP alignment	64		
Troubleshooting	91		
Turning off boxing	61		
Turning off framing	61		
Turning off mirror printing	67		
Turning off underlining	60		



# GUÍA DEL USUARIO

## **SU P-TOUCH**

Su nuevo P-TOUCH le permitirá diseñar e imprimir etiquetas para cualquier aplicación. Además, empleando la amplia variedad de cassettes disponibles, podrá imprimir etiquetas con anchuras diferentes y hermosos colores.

Para poder consultar este manual cuando sea necesario, le aconsejamos que lo guarde en un lugar que le quede a mano.

### **AVISO DE FCC**

Este equipo ha sido probado y se ha encontrado que satisface los límites para dispositivos digitales de Clase B, según la Parte 15 de las Normas de FCC. Estos límites están preparados para proporcionar una protección razonable contra la interferencia dañina en instalaciones residenciales. Este equipo genera, emplea, y puede radiador energía de radiofrecuencia y, si no se instala de acuerdo con las instrucciones, puede causar interferencias perjudiciales en las radiocomunicaciones. Sin embargo, no se garantiza que no ocurrirán interferencias en una instalación en particular. Si este equipo causa interferencias perjudiciales en la recepción de radio o televisión, lo cual puede determinarse conectando y desconectando el equipo, se aconseja al usuario que corrija la interferencia mediante una o más de las medidas siguientes:  
Reoriente o reubique la antena de recepción.

Aumente la separación entre el equipo y el receptor.

Conecte el equipo a una toma de corriente que esté en un circuito distinto al que se ha conectado el receptor.

Consulte al distribuidor o a un técnico experimentado en radio/TV.

Los cambios o modificaciones no expresamente aprobados por Brother Industries, Ltd. puede invalidar la autoridad del usuario para operar el equipo.

### **Este equipo está cubierto por una o más de las patentes siguientes.**

USP4839742	USP4983058	EP315369	GB2223740
USP4922063	USP5009530	EP322918	
USP4927278	USP5069557	EP322919	
USP4966476	USP5120147		
USP4976558			



# ÍNDICE

SU P-TOUCH	
ÍNDICE.....	1
INTRODUCCIÓN A ESTE MANUAL.....	2
PRECAUCIONES GENERALES.....	2
CASSETTES DE CINTAS.....	3
LIMPIEZA DEL CABEZAL DE IMPRESIÓN.....	4
INSERCIÓN DE LAS PILAS.....	5
TECLAS SHIFT, ALT Y CAPS.....	6
TECLA CODE.....	7
FUNCIONES DE EDICIÓN DE TEXTO.....	7
FUNCIONES DE LA MEMORIA.....	9
SÍMBOLOS.....	10
NUMERACIÓN SECUENCIAL.....	11
JUEGO DE CARACTERES.....	13
ANCHURA.....	14
ESTILO.....	15
ALINEACIÓN HORIZONTAL.....	16
ALINEACIÓN VERTICAL.....	17
IMPRESIÓN Y AVANCE DE LA CINTA.....	18
CÓDIGOS DE BARRAS.....	20
ESPECIFICACIONES DEL P-TOUCH.....	23

## INTRODUCCIÓN A ESTE MANUAL

A pesar de que el P-TOUCH es de fácil utilización, le aconsejamos que lea este manual con atención antes de empezar a utilizarlo.

Buena suerte! Le deseamos que la utilización del P-TOUCH le resulte agradable.

## PRECAUCIONES GENERALES

- No tire de la cinta. Podría dañar los cassettes de cinta.
- No limpie el P-TOUCH con alcohol ni otros disolventes orgánicos. Utilice únicamente un paño suave y seco.
- No toque el borde del cortador para evitar daños personales.
- No deposite nada sobre el P-TOUCH ni en su interior.
- No utilice este aparato en lugares con mucho polvo. Evita la incidencia directa de la luz solar y la exposición a la lluvia.
- No deje objetos de goma o de vinilo sobre el P-TOUCH durante largos períodos de tiempo. Estos materiales podrían ocasionar su oxidación.
- No exponga la máquina a altas temperaturas ni alta humedad. No la deje nunca en el tablero de instrumentos ni maletero de un automóvil.
- Utilice sólo el adaptador de CA diseñado exclusivamente para el P-TOUCH. (AD-8000)
- Si no va a utilizar este aparato durante un período de tiempo prolongado, extraiga las pilas y/o desconecte el adaptador de CA.
  - ☞ *Cuando se desconecta la alimentación, todos los mensajes que pudieran estar en el área de trabajo o en el área de la memoria de mensajes se perderán.*
- Si la temperatura ambiental es alta, intente asegurarse de que el parámetro de densidad (DENSITY) no está ajustado a "+1" ni "+2", porque podría causar la ruptura de la cinta de dentro del cassette durante la impresión.

## CASSETTES DE CINTAS

Junto con esta unidad se suministra una cassette de cinta. Sin embargo, podrá encontrar cintas para el P-TOUCH en una gran variedad de colores de fondo, colores de las letras y anchos de la cinta.

### INSERCIÓN DE UNA CASSETTE DE CINTA

- (1) Deslice el cierre de la cubierta del cassette hacia la derecha para abrir la cubierta. Levante la cubierta para poder tomar con facilidad el cassette de cinta. De este modo también se liberará cualquier cassette instalado.
- (2) Si ya hay un cassette de cinta en el compartimiento, extráigalo tirand del mismo hacia arriba.
- (3) Extraiga el tope del nuevo cassette de cinta. Si la cinta del interior del cassette está floja, emplee el dedo para dar una vuelta en la dirección de la flecha del cassette de cinta de plástico.
- (4) Inserte el nuevo cassette de cinta firmemente en el compartimiento.
- (5) Cierre la cubierta del compartimiento.
- (6) Pulse una vez la tecla **FEED** y corte la cinta para tensar la cinta.

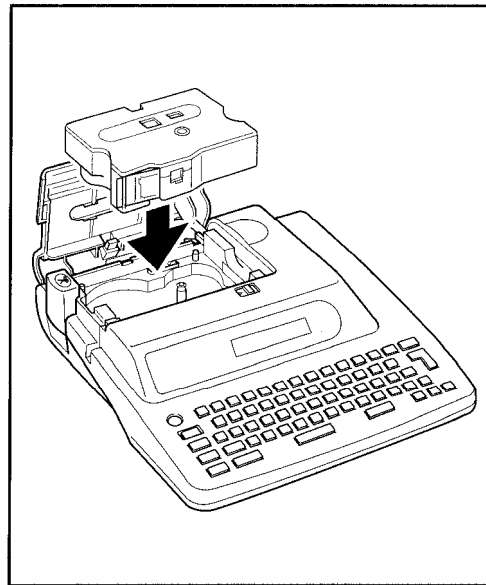
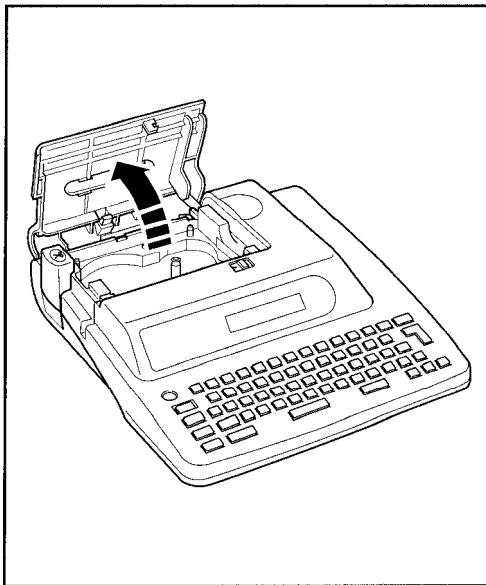

## LIMPIEZA DEL CABEZAL DE IMPRESIÓN

El polvo o suciedad en el cabezal de impresión de la máquina puede evitar que la máquina imprima correctamente. Normalmente, pueden aparecer líneas blancas en la etiqueta impresa.

Para evitarlo, limpie de vez en cuando el cabezal de impresión de la máquina.

### CÓMO LIMPIAR LA COLUMNA DEL CABEZAL DE IMPRESIÓN

- (1) Desconecte la alimentación de la máquina.
- (2) Abra la cubierta del compartimiento de la cassette y saque el cassette de cinta.
- (3) Frote el cabezal de impresión con cuidado con un palillo de algodón seco en la dirección desde arriba hacia abajo. Realice otra vez una impresión de prueba.

Si queda suciedad:

- (4) Humedezca el palillo de algodón en alcohol isopropílico y repita el paso (3).

Si nada de lo mencionado soluciona el problema, póngase en contacto con el representante de servicio.

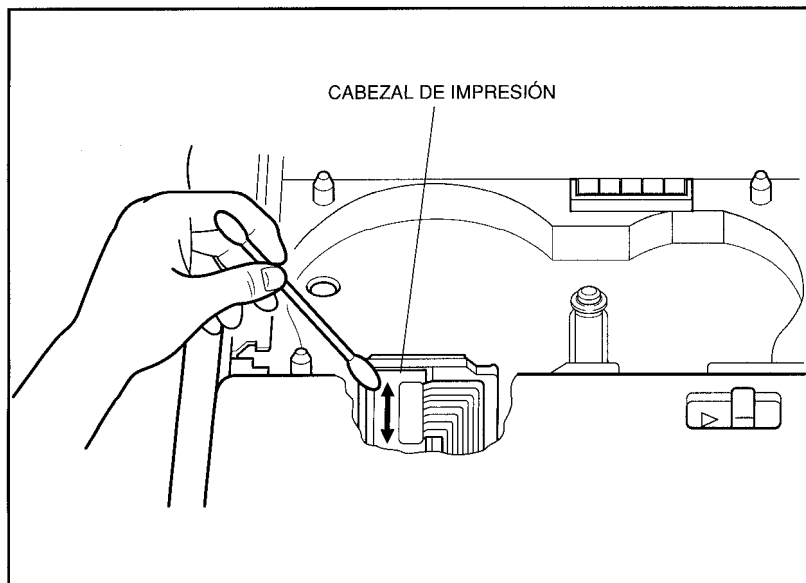

 No toque el mecanismo del cabezal de impresión con los dedos. Si se toca el cabezal, límpielo inmediatamente con una frotación suave (como por ejemplo con el palillo de algodón) para evitar daños permanentes.

## INSERCIÓN DE LAS PILAS

El P-TOUCH funciona con seis pilas del tamaño "C". Es preferible que emplee pilas alcalinas. Cuando cambie las pilas, hágalo siempre cambiando las seis al mismo tiempo.

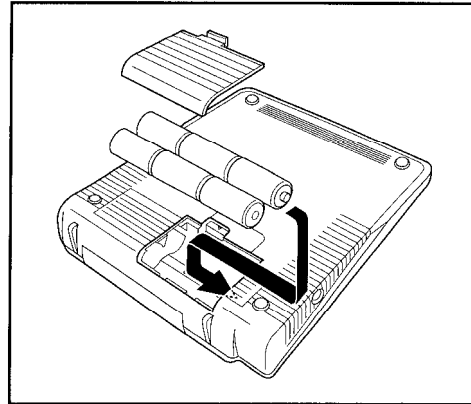
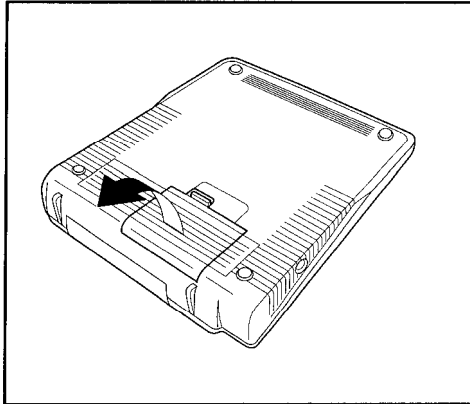

- ☞ *Asegúrese de que inserta las pilas nuevas antes de que transcurran cinco minutos desde que haya extraído las pilas viejas, porque de lo contrario el mensaje del área de trabajo y todos los mensajes almacenados en la memoria de frases se perderían (a menos que el P-TOUCH esté enchufado a un adaptador de CA).*

### **NOTA IMPORTANTE SOBRE EL FUNCIONAMIENTO CON PILAS**

Su P-TOUCH puede imprimir caracteres grandes y atractivos en una amplia variedad de formatos. Sin embargo, si se imprimen de forma regular, particularmente en cinta ancha, pueden causar un gran esfuerzo de las pilas. Por lo tanto, para evitar el desgaste prematuro de las pilas, se recomienda el empleo de un adaptador de CA opcional para imprimir tipos grandes de caracteres, códigos de barras y símbolos en grandes cantidades en cinta de 18 mm y de 24 mm.

# TECLAS SHIFT, ALT Y CAPS

## DESCRIPCIÓN GENERAL

Pueden introducirse la mayor partes de caracteres simplemente pulsando las teclas correspondiente. Sin embargo, para introducir letras en mayúsculas, caracteres acentuados y los símbolos más comunes, son necesarias tres teclas especiales.

**TECLA SHIFT:** Esta tecla le permit escribir letras en mayúsculas y los símbolos que se encuentran en la parte superior de las teclas. Para escribir una "A" mayúscula, mantenga pulsada la tecla **SHIFT** y pulse la tecla "A".

**TECLA CAPS:** La tecla SHIFT es muy útil para introducir una única letra en mayúsculas; por ejemplo al principio de un nombre. Sin embargo, si desea introducir una serie de letras en mayúsculas, es aconsejable que utilice la tecla CAPS que fija las mayúsculas.

### PARA ACCEDER AL MODO CAPS

Mantenga pulsada la tecla **CODE** y pulse la tecla **CAPS**.

El mensaje "CAPS ON" aparece brevemente en la pantalla LCD.

☞ *Cuando el modo CAPS esté activado, al utilizar la tecla **SHIFT** para escribir las letras se escribirán en minúsculas.*

En el modo CAPS, podrá escribir letras en mayúsculas simplemente pulsando las teclas de los caracteres (es decir, no es necesario que pulse la tecla **SHIFT**). Sin embargo, cuando pulse las teclas numéricas se escribirán los números y no los símbolos que se encuentran en la parte superior de las teclas. Para escribir un símbolo impreso en la parte superior de una tecla, mantenga pulsada la tecla **SHIFT** y pulse la tecla correspondiente.

Para desactivar el modo CAPS, mantenga pulsada la tecla **CODE** y pulse de nuevo la tecla **CAPS**. El mensaje "CAPS OFF" aparece brevemente en la pantalla LCD.

**TECLA ALT:** La tecla **ALT** le permite introducir los caracteres y símbolos que se encuentran en la parte derecha de las teclas.

### PARA INTRODUCIR UN CARÁCTER DEL LADO DERECHO DE UNA TECLA

Pulse la tecla **ALT**.

Mantenga pulsada la tecla **ALT** y pulse la tecla con el carácter a su lado derecho.

## TECLA CODE

### DESCRIPCIÓN GENERAL

Las teclas **SHIFT**, **CAPS**, y **ALT** le permiten seleccionar varios caracteres y símbolos, y la tecla **CODE** le permite seleccionar varios modos y funciones. Debe seleccionar las funciones y los modos que aparecen impresos de color verde en el teclado manteniendo pulsada la tecla **CODE**.

### EJEMPLO

Para emplear la función de llamada de la memoria:

- Pulse  +   .

Para introducir el modo de símbolos:

- Pulse  +   .

## FUNCIONES DE EDICIÓN DE TEXTO

### MOVIMIENTO DEL CURSOR



el cursor se desplaza un espacio hacia la izquierda (o, si el cursor se encuentra en el primer carácter de una línea, el cursor se desplazará al final de la línea previa.)



el cursor se desplaza un espacio hacia la derecha (o, si el cursor se encuentra en el último carácter de una línea, el cursor se desplazará al principio de la línea siguiente.)



el cursor se desplazará al primer carácter de la línea previa.



el cursor se desplazará al primer carácter de la línea siguiente.

## BORRADO DE TEXTO



borra el carácter situado a la izquierda del cursor. Si el cursor está debajo del primer carácter de una línea, se borra la marca de retorno de la línea anterior y se unen las dos líneas.

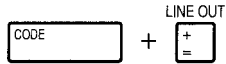

borra por completo la línea actual, incluyendo la marca de retorno. Si la línea es la última línea de un bloque, permanece la marca de retorno de bloque.

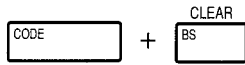

borra por completo el mensaje actual, incluyendo todo el texto, las marcas de retorno y las marcas de retorno de bloque.

## DESPLAZAMIENTO DEL CURSOR DE BLOQUE A BLOQUE



el cursor se desplaza al primer carácter del bloque de texto actual. Pulse al mismo tiempo las dos teclas por segunda vez para que el cursor se desplace al primer carácter del bloque anterior.



el cursor se desplaza al primer carácter del bloque de texto siguiente.



el cursor se desplaza directamente al primer carácter de todo el mensaje.



el cursor se desplaza directamente al último carácter de todo el mensaje.



## FUNCIONES DE LA MEMORIA

Podrá almacenar los mensajes de etiquetas en la memoria de frases del P-TOUCH y luego podrá recuperarlos. La memoria tiene cabida para unos 2000 caracteres. Un mensaje puede tener hasta 220 caracteres de longitud.



le permite almacenar el mensaje actual en la memoria.



le permite recuperar un mensaje de la memoria.



le permite borrar uno o más mensajes de la memoria del modo siguiente:

Pulse la tecla **RETURN** () para borrar un solo archivo.

Pulse la tecla **SPACE** para iluminar archivos individuales y luego la tecla **RETURN** para borrarlos.

Mantenga pulsada la tecla **CODE** y pulse la tecla **CLEAR** para borrar todos los archivos de la memoria.

En cada caso, se le pedirá que responda al mensaje de confirmación pulsando la tecla **RETURN**. Para abandonar el borrado, pulse la tecla **CANCEL**.

 Para seleccionar un número de archivo para el mensaje que está almacenando, o para visualizar el archivo que desea recuperar o borrar, pulse las teclas **▲** o **▼**.

Para incrementar o reducir el número del archivo que está almacenando, recuperando, o borrando en diez en lugar de en uno, mantenga pulsada la tecla **SHIFT** y pulse las teclas **▲** i **▼** key.

Para revisar el contenido de un mensaje, desplácese en el mismo usando las teclas **▶** y **◀**.

# SÍMBOLOS

## DESCRIPCIÓN GENERAL

Además de los caracteres y símbolos de la parte superior de las teclas del P-TOUCH, hay otros símbolos que también estarán disponibles. Podrá añadir estos símbolos a sus mensajes, o borrarlos, al igual que con cualquier otro carácter.

## FUNCIONAMIENTO

### PARA INTRODUCIR UN SÍMBOLO QUE NO SE ENCUENTRE EN UNA TECLA

- (1) Desplace el cursor al punto en el que desea introducir el símbolo.
- (2) Mantenga pulsada la tecla **CODE** y pulse la tecla **SYMBOL**.
- (3) Pulse las teclas ▲ y ▼ hasta que grupo de símbolos que contenga el símbolo que desea introducir aparezca en la pantalla.
- (4) Pulse las teclas ► y ◀ hasta que el símbolo deseado parpadee.
- (5) Pulse la tecla **RETURN** para introducir el símbolo en el mensaje.

## LISTA

S Y M B O L : ↑ ↓ → ← ↶ ↷ ↸ ↹ +

S Y M B O L : ➡ ⬅ ⬆ ⬇ © ® ™ ☎ ☑

S Y M B O L : ★ ● ○ □ @ ♪ † ‡ ♿

S Y M B O L : ♂ ♀ ☢ ☣ ⚡ ☈ ☑ ☒ ☓

S Y M B O L : ☹ ☺ ☻ ☼ ✖ ☽ ☾ ☿

S Y M B O L : ≡ Ω ~ ≡ ☐ ≡ Δ ∞ †

S Y M B O L : . / 2 3 4 5 6 7 8 9

# NUMERACIÓN SECUENCIAL

## DESCRIPCIÓN GENERAL

Usted podrá designar un grupo de números y/o letras, o un código de barras, como campo de "numeración". Al imprimir una serie de etiquetas, los números, las letras o código de barras incluidos en el campo aumentan en uno de manera automática. Esto es muy útil para imprimir etiquetas con números consecutivos en serie para el control de existencias o aplicaciones similares.

## FUNCIONAMIENTO

El procedimiento para emplear número y letras para numeración y el procedimiento para un numeración de un código de barras es algo distinto.

### PARA DESIGNAR NÚMEROS Y/O LETRAS COMO UN CAMPO NUMÉRICO

- (1) Coloque el cursor bajo el primer carácter (número o letra) que desee incluir en el campo.
- (2) Mantenga pulsada la tecla **CODE** y pulse la tecla **SEQUENTIAL NUMBERING**. "SELECT FIELD" aparecerá brevemente; entonces, el carácter seleccionado parpadeará, indicando que está "activo".
- (3) Utilice las teclas **►** y **◄** para mover el cursor al último carácter que desee incluir. Todos los caracteres entre éste y el primero también parpadearán.
- (4) Pulse la tecla **RETURN**. Los signos de numeración (¶N N¶) aparecerán en la pantalla en torno al campo de numeración (los caracteres que parpadearaban anteriormente).
- (5) Pulse la tecla **PRINT**. Aparecerá el menú de selección de "ajustes de impresión".
- (6) Pulse la tecla **►** hasta que el ajuste de incremento "INCREASES" parpadee.
- (7) Pulse las teclas **▲** y **▼** hasta que se visualice el ajuste deseado. Si desea que se cuente del número 10 al 15, ajuste los incrementos "INCREASES" a "6" (10, 11, 12, 13, 14, 15 es 6 pasos).
- (8) Pulse la tecla **RETURN**.

- ☞ *En un mensaje de texto sólo puede crear un campo de numeración.  
El número máximo de caracteres de un campo de numeración es de diez.  
Un campo de numeración debe encontrarse totalmente en una única línea.  
Si borra uno de los signos de campos de numeración, desaparecerán los dos y el campo de numeración se tratará como texto normal.*

### PARA DESIGNAR UN CÓDIGO DE BARRAS COMO CAMPO NUMÉRICO

- (1) Sitúe el cursor debajo de "◄" o de "|||" de "◄ |||" en el código de barras.
- (2) Mantenga pulsada la tecla **CODE** y pulse la tecla **SEQUENTIAL NUMBERING**.
- (3) Ahora podrá aplicar la función de numeración al código de barras. Las marcas de numeración (¶N N¶) aparecerán en el visualizador, en torno al campo de numeración.

- (4) Pulse la tecla **PRINT**. Aparecerá el menú de "ajustes de impresión".
- (5) Pulse la tecla **▶** hasta que el ajuste de incremento "INCREASES" parpadee.
- (6) Pulse las teclas **▲** y **▼** hasta que el ajuste deseado se visualice. Si desea que el número cuente progresivamente desde 10 a 15, ajuste "INCREASES" a "6" (10, 11, 12, 13, 14, 15 es 6 pasos).
- (7) Pulse la tecla **RETURN**.

 *Un campo de numeración de código de barras no puede contener ningún número o letra adicionales. Sólo pueden usarse números en un campo de numeración de código de barras. Un campo de numeración que no es de código de barras puede usar las gamas siguientes de números y letras.*

0	➔	1	➔	....	9	➔	0	➔	....
A	➔	B	➔	....	Z	➔	A	➔	....
a	➔	b	➔	....	z	➔	a	➔	....

*Los espacios pueden usarse para ajustar el número de dígitos impresos:*

「NON」	0	➔	1	➔	....	9	➔	0	➔	....
「N ON」	0	➔	1	➔	....	99	➔	0	➔	....
「NAON」	A0	➔	A1	➔	....	A9	➔	B0	➔	....

*Los espacios entre los caracteres de numeración simplemente ajustan el espacio entre ellos en las etiquetas impresas.*

「N 1 2 3 N」	1 2 3	➔	1 2 4
-------------	-------	---	-------

*Los caracteres que no son alfanuméricos de dentro del campo de numeración se imprimen pero no se cambian ni incrementan de ninguna forma.*

*En un código de barras, sólo los números pueden incluirse para la numeración automática. La numeración puede ir desde 0 a 999.*

▶ *123ABCD999*
↓
▶ *123ABCD000*

*En un código de barras de formato CODE 39, el carácter de inmediatamente antes del asterisco es el carácter que cambia. Si la función de dígito de comprobación está activada, los dos caracteres de delante del asterisco incrementarán en valor según proceda la numeración automática.*

*En un código de barras de formato CODABAR, el carácter de inmediatamente antes del código END es el que cambia.*

*De acuerdo con la norma de numeración ISBN, sólo se incrementan los primeros 12 dígitos de un número.*

# JUEGO DE CARACTERES

## DESCRIPCIÓN GENERAL

Existen dos tipos de caracteres, o juegos, en el P-TOUCH, que son: el juego de caracteres A y el juego de caracteres B.

## FUNCIONAMIENTO

### PARA SELECCIONAR UN JUEGO DE CARACTERES

- (1) Pulse la tecla **FORMAT** o la tecla **LOCAL FORMAT**.
- (2) Pulse la tecla **▶** hasta que parpadee el campo del juego de caracteres (FONT).
- (3) Pulse las teclas **▲** y **▼** hasta que se visualice el juego de caracteres que desee utilizar ("A" o "B").
- (4) Pulse la tecla **RETURN**.

## EJEMPLO

JUEGO A

ABCDEFGFG

JUEGO B

ABCDEFGFG

# ANCHURA

## DESCRIPCIÓN GENERAL

Podrá seleccionar una de las tres anchuras siguientes de los juegos de caracteres: media (M), estrecha (N), o ancha (W).

## FUNCIONAMIENTO

### PARA SELECCIONAR UNA ANCHURA

- (1) Pulse la tecla **FORMAT** o la tecla **LOCAL FORMAT**.
- (2) Pulse la tecla **▶** hasta que parpadee el campo del anchura (WIDTH).
- (3) Pulse las teclas **▲** y **▼** hasta que se visualice la anchura que desee utilizar.  
 Para seleccionar "M", pulse simplemente la tecla **SPACE**.
- (4) Pulse la tecla **RETURN**.

## EJEMPLO

Seleccione el tipo que desee seleccionando una combinación de tamaño y anchura de caracteres. A continuación se muestran algunos ejemplos.

ANCHURA TAMAÑO	ANCHA (W)	MEDIA (M)	ESTRECHA (N)
38pt	ABC	ABC	ABC
19pt	ABC	ABC	ABC
10pt	ABC	ABC	ABC
6pt	ABC	ABC	ABC

(Tamaño real)

# ESTILO

## DESCRIPCIÓN GENERAL

Disponde de un total de diez estilos de caracteres: seis estilos sencillos y cuatro combinaciones, que son:

- Normal (NORM.) Cursiva (ITAL.)
- Perfilado (OUTL.) Cursiva y perfilado (I+OUT)
- Negrilla (BOLD)Cursiva y negrilla (I+BLD)
- Sombra 1 (SHAD1)Cursiva y sombra 1 (I+SH1)
- Sombra 2 (SHAD2) Cursiva y sombra 2 (I+SH2)

☞ Cuando emplee caracteres de pequeño tamaño, algunos ajustes de estilo (como cursiva + sombra 2) pueden resultar algo ilegibles al salir impresos.

## FUNCIONAMIENTO

### PARA SELECCIONAR UN ESTILO

- (1) Pulse la tecla **FORMAT** o la tecla **LOCAL FORMAT**.
- (2) Pulse la tecla **▶** hasta que parpadee el campo del estilo **STYLE**.
- (3) Pulse las teclas **▲** y **▼** hasta que se visualice el estilo deseado.
- ☞ Para seleccionar "NORM.", pulse simplemente la tecla **SPACE**.
- (4) Pulse la tecla **RETURN**.

## EJEMPLO

	NORM.	BOLD	SHAD1
JUEGO A	ABCDE	ABCDE	ABCDE
JUEGO B	ABCDE	ABCDE	ABCDE

	I+OUT	I+SH2
JUEGO A	<i>ABCDE</i>	<i>ABCDE</i>
JUEGO B	<i>ABCDE</i>	<i>ABCDE</i>

# ALINEACIÓN HORIZONTAL

## DESCRIPCIÓN GENERAL

Puede alinear horizontalmente los caracteres de los bloques de su mensaje de cuatro maneras diferentes:

Izquierda (LEFT)  
Centro (CTR)  
Derecha (RGHT)  
Justificado (JUST)

## FUNCIONAMIENTO

### PARA SELECCIONAR UNA ALINEACIÓN HORIZONTAL:

- (1) Pulse la tecla **FORMAT**.
- (2) Pulse la tecla **►** hasta que parpadee el campo de la alineación horizontal (HORIZONTAL ALIGNMENT).
- (3) Pulse las teclas **▲** y **▼** hasta que se visualice el ajuste de la alineación horizontal deseada.

 Para seleccionar "LEFT", pulse simplemente la tecla **SPACE**.

- (4) Pulse la tecla **RETURN**.

 El ajuste de la alineación horizontal sólo puede hacerse de forma global. No está disponible en el formato especial.

*Cuando se justifica un mensaje de bloques múltiples en una cinta de la longitud predeterminada, se asignará el ajuste "JUST", con lo que los espacios entre los bloques se ajustarán para que el mensaje quede uniformemente distribuido por toda la longitud de la cinta.*

## EJEMPLO

LEFT	CTR	RGHT	JUST
ABC DEFGHIJ KLNOP G	ABC DEFGHIJ KLNOP G	ABC DEFGHIJ KLNOP G	A B C DEFGHIJ K L N O P G



# ALINEACIÓN VERTICAL

## DESCRIPCIÓN GENERAL

Puede alinear verticalmente las líneas de los bloques de su mensaje de tres maneras diferentes:

Inferior (BTM)  
Centro (CTR)  
Superior (TOP)

## FUNCIONAMIENTO

### PARA SELECCIONAR UNA ALINEACIÓN VERTICAL:

- (1) Pulse la tecla **FORMAT**.
- (2) Pulse la tecla **►** hasta que parpadee el campo de la alineación vertical (VERTICAL ALIGNMENT).
- (3) Pulse las teclas **▲** y **▼** hasta que se visualice el ajuste de la alineación vertical deseada.

☞ *Para seleccionar "BTM", pulse simplemente la tecla **SPACE**.*

- (4) Pulse la tecla **RETURN**.

☞ *El ajuste de la alineación vertical sólo puede hacerse de forma global. No está disponible en el formato especial.*

## EJEMPLO

TOP    ABCABC<sup>ABCDE<sup>ABC</sup></sup>

CTR    ABCABC<sub>ABCDE<sub>ABC</sub></sub>

BTM    ABCABC<sub>ABCDE<sub>ABC</sub></sub>

# IMPRESIÓN Y AVANCE DE LA CINTA

## DESCRIPCIÓN GENERAL

La tecla de impresión **PRINT** le permite imprimir el texto formateado que haya creado en una cinta. En el modo de impresión, puede determinar cinco parámetros diferentes.

PARÁMETRO	AJUSTES POSIBLES
Tape Feed (avance de cinta)	FULL (grande) (1"), MEDIUM (medio) (1/2"), NARROW (reducido) (1/3"), NONE (ninguno) (1/6")
Copies (copias) _____	1 a 99
Numbering Increases (aumento de numeración) —	OFF, 1 a 99
Cut Pause (pausa de corte)	ON, OFF
Density (densidad) _____	NORMAL, +1, +2, -2, -1

**TAPE FEED** Las etiquetas pueden tener márgenes "FULL" (1"), MEDIUM (medio) (1/2"), NARROW (reducido) (1/3"), o NONE (ninguno) (1/6").

Cuando se imprime una o más etiquetas, 1 pulgada de cinta siempre se avanza antes del primer carácter de la primera etiqueta (vea CUT PAUSE más abajo). Para mensajes de códigos de barras, emplee el avance de cinta "Full", porque de lo contrario podría afectarse la calidad de lectura del código de barras.

**COPIES** El ajuste "COPIES" determina el número de copias que se imprimirán de la etiqueta actual. Cuando el texto incluya un campo de numeración, este ajuste determina el número de copias que se imprimirán para cada valor del campo de numeración.

**NUMBERING INCREASES** Este ajuste determina el número de valores diferentes que tomará el campo de numeración. Vea "Numeración secuencial".

**CUT PAUSE** Lo mejor es ajustar "CUT PAUSE" si imprime una etiqueta con el ajuste de margen "NONE". "NARROW", o "MEDIUM", o imprimir varias etiquetas a cualquier ajuste de margen (tanto copias múltiples de la misma etiqueta, o etiquetas secuencialmente numeradas).

Si "CUT PAUSE" está activado ("ON"), se le indicará que corte el exceso de cinta inicial y entonces en cada etiqueta individual mediante el mensaje "CUT NOW".

Si "CUT PAUSE" está desactivado ("OFF"), las etiquetas se imprimirán en una franja continua de cinta y todo el exceso de antes de la primera etiqueta permanecerá.

**DENSITY** La densidad de impresión afecta el grado de oscuridad con el que se imprimirá. La densidad se ajusta normalmente a "NORMAL" pero puede ajustarse para hacer más oscuro el texto de la etiqueta ("1" ó "2") o más claro ("-1" ó "-2").

## FUNCIONAMIENTO

### PARA IMPRIMIR UNA ETIQUETA

(1) Pulse la tecla **PRINT**. Aparecerá el menú de selección de los ajustes de impresión.

(2) Para utilizar los ajustes por defecto (dados abajo), pulse simplemente la tecla **RETURN**.

Para editar los ajustes de impresión:

(3) Pulse las teclas **▶** y **◀** hasta que parpadee el primer ajuste que desea cambiar.

(4) Pulse las teclas **▲** y **▼** hasta que se visualice el ajuste deseado.

☞ *Si no desea emplear la función de numeración, seleccione "OFF" simplemente presionando la tecla **SPACE**.*

(5) Repita los pasos (3) y (4) hasta que todos los ajustes sean los deseados.

(6) Pulse la tecla **RETURN**.

☞ *Si "CUT PAUSE" se ajusta a "OFF", no presione la palanca del cortador mientras el P-TOUCH está imprimiendo.*

*Si decide cancelar la impresión a la mitad, pulse la tecla **CANCEL**, y pulse entonces la tecla **FEED** para avanzar el resto de la etiqueta parcialmente impresa. Finalmente, pulse la palanca del cortador para cortar la cinta.*

## EJEMPLO

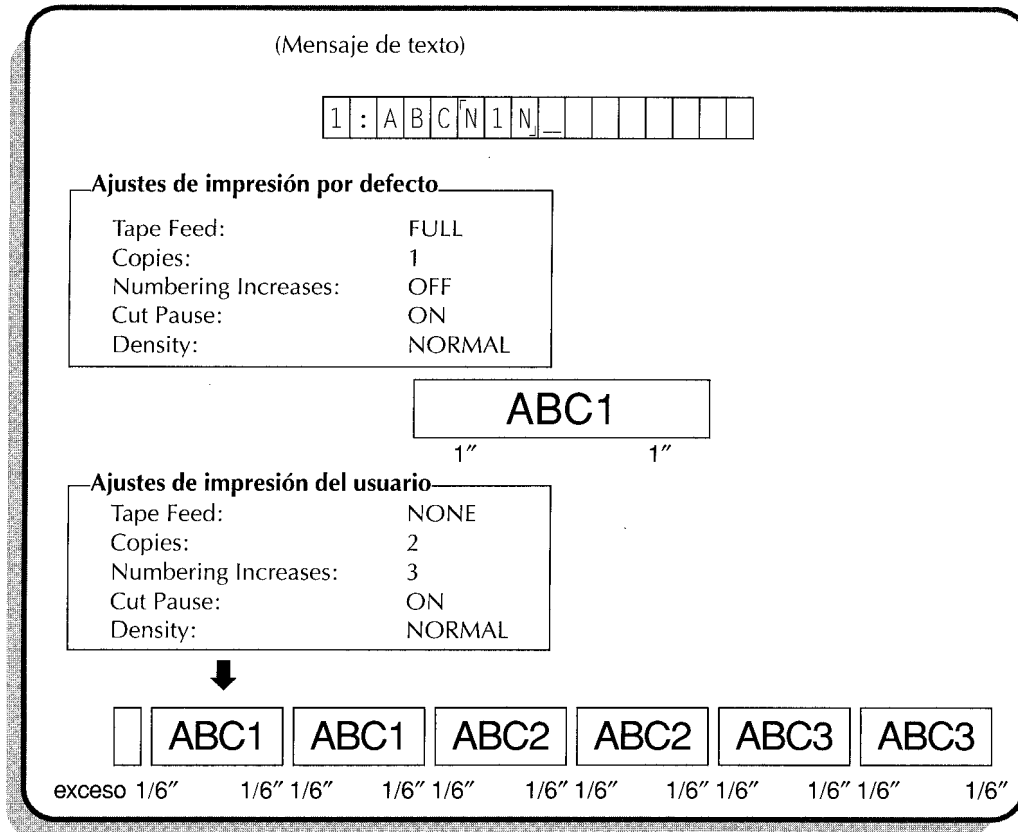

# CÓDIGOS DE BARRAS

## DESCRIPCIÓN GENERAL

El P-TOUCH puede imprimir códigos de barras como parte de una etiqueta.

☞ Emplee caracteres negros sobre cinta blanca para las etiquetas con código de barras.

*Para seleccionar un valor por defecto de un parámetro, pulse simplemente la tecla **SPACE**.*

*Las etiquetas de código de barras deben imprimirse a una anchura Media (MEDIUM) o grande (LARGE), usando un avance de cinta "FULL", porque de lo contrario pueden no ser legibles.*

*En cualquier caso, es posible que algunos lectores no puedan leer las etiquetas producidas por el P-TOUCH.*

*Un mensaje que conste sólo de letras y números puede tener una altura máxima de 96 puntos más el tamaño de cualquier encuadre. Sin embargo, un mensaje que contiene un código de barras, puede tener una altura máxima de 72 puntos.*

Pueden ajustarse seis parámetros de códigos de barras.

PARÁMETRO	AJUSTES POSIBLES
PROTO (protocolo) —	CODE 39, I-2/5, EAN13, EAN8, UPC-A, UPC-E, CODABAR, EAN 128, CODE 128, ISBN 5, ISBN 2
WIDTH (Anchura del código de barras) —	Media (M), pequeña (S), grande (L)
UNDER # S: (Caracteres impresos debajo del código de barras) —	ON, OFF
# OF CHARS (N.º de caracteres en el código)—	AUTO, 4 a 22
RATIO (Relación)—	3:1, 2,5:1, 2:1
CHECK DIG.: (Dígito de comprobación) —	OFF, ON

## FUNCIONAMIENTO

### PARA INTRODUCIR UN CÓDIGO DE BARRAS EN UN MENSAJE

- (1) Mantenga pulsada la tecla **CODE** y pulse la tecla **BAR CODE**. Aparecerán brevemente los ajustes de código de barras y los datos más recientemente introducidos.

(2) Compruebe y, si es necesario, edite los ajustes de código de barras del modo siguiente:

 Si ajusta el dígito de comprobación, el protocolo, o número de caracteres, intente comprobar que estos ajustes son los apropiados antes de introducir los datos del código de barras.

(3) Pulse la tecla **FORMAT**.

(4) Pulse las teclas **▶** y **◀** hasta que parpadee el primer ajuste que desee cambiar.

(5) Pulse las teclas **▲** y **▼** hasta que aparezca el ajuste que desee utilizar.

(6) Repita los pasos (4) y (5) hasta que haya cambiado todos los ajustes deseados.

(7) Pulse la tecla **RETURN**.

(8) Escriba el código de barras.

(9) Cuando haya terminado, pulse la tecla **RETURN**.

### EJEMPLO

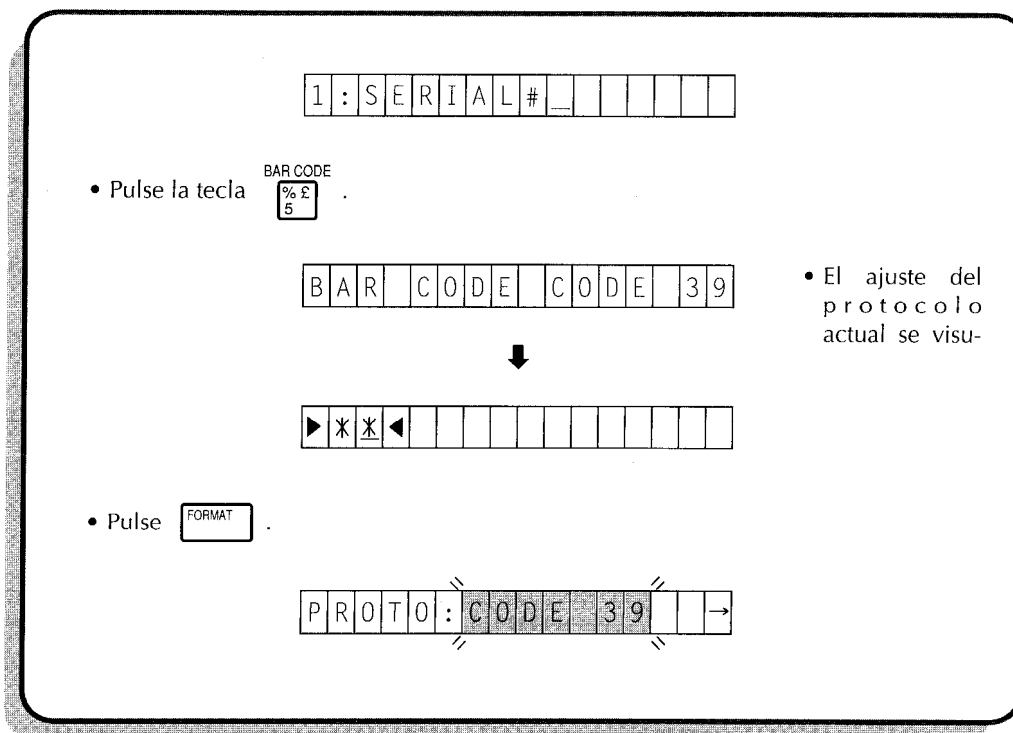

1: SERIAL#

- Pulse la tecla  .

BAR CODE CODE 39

- El ajuste del protocolo actual se visu-

▶ \* \* ◀

- Pulse  .

PROTO: CODE 39 →

# INTRODUCCIÓN DE DATOS USANDO LOS CARACTERES ESPECIALES (QUE NO ESTÁN EN EL TECLADO)

Cuando se selecciona el protocolo del código de barras CODE128 o EAN128, podrá introducir los datos del código de barras usando cualquiera de los 128 caracteres ASCII. Estos constan de los caracteres mostrados en la parte superior de las teclas más lo siguiente:

VALUE 28	<	VALUE 74	LF	VALUE 88	CAN
VALUE 30	>	VALUE 75	VT	VALUE 89	EM
VALUE 60	\	VALUE 76	FF	VALUE 90	SUB
VALUE 63	_	VALUE 77	CR	VALUE 91	ESC
VALUE 64	NUL	VALUE 78	SO	VALUE 92	FS
VALUE 65	SOH	VALUE 79	SI	VALUE 92	I
VALUE 66	STX	VALUE 80	DLE	VALUE 93	GS
VALUE 67	ETX	VALUE 81	DC1	VALUE 94	RS
VALUE 68	EOT	VALUE 82	DC2	VALUE 95	US
VALUE 69	ENQ	VALUE 83	DC3	VALUE 95	DEL
VALUE 70	ACK	VALUE 84	DC4	VALUE 96	FNC 3
VALUE 71	BEL	VALUE 85	NAK	VALUE 97	FNC 2
VALUE 72	BS	VALUE 86	SYN	VALUE 100	FNC 4
VALUE 73	HT	VALUE 87	ETB	VALUE 102	FNC 1

## FUNCIONAMIENTO

### INTRODUCCIÓN DE DATOS PARA LOS CÓDIGOS DE BARRAS CODE128 O EAN128 USANDO CARACTERES QUE NO ESTÁN EN EL TECLADO

- (1) Mantenga pulsada la tecla **CODE** y pulse la tecla **BAR CODE**. Aparecerá la pantalla de entrada de datos de código de barras.
- (2) Cuando introduzca los datos del código de barras, sitúe el cursor en el punto en el que desee introducir el carácter que no está en el teclado, y entonces mantenga pulsada la tecla **CODE** y pulse la tecla **SYMBOL**.
- (3) Pulse las teclas ▲ y ▼ hasta que el carácter que desea usar esté parpadeando.

 Pulse la tecla **SPACE** para seleccionar VALUE 28 (<).

- (4) Pulse la tecla **RETURN**. La pantalla volverá a la pantalla de entrada de información de código de barras y los datos del carácter se añadirá al código de barras. En la pantalla, aparecerá un cuadrado (□) en el código de barras en el lugar en el que usted haya introducido el carácter especial (a menos que sea '<', '>', '\', '\_' o '|', en cuyo caso aparecerá el mismo carácter).

 Las ilustraciones siguientes muestran lo que aparece debajo del código de barras cuando se inserta un carácter especial que no es '<', '>', '\', '\_' ni '|', y lo que aparece cuando se inserta un carácter '>'.



## ESPECIFICACIONES DEL P-TOUCH

### HARDWARE

Dispositivo de entrada de datos:	TECLADO - 64 teclas
LCD:	7 x 5 puntos / 1 línea x 16 columnas
Cinta de impresión:	Sensible a la presión con base adhesiva. 15 m de longitud. 5 anchuras disponibles. 6 mm (1/4") 9 mm (3/8") 12 mm (1/2") 18 mm (3/4") 24 mm (1")
Alimentación:	Adaptador de CA opcional o pilas
Cabezal de impresión:	128 puntos / 180 dpi  Area imprimible 96 puntos + encuadre
Dimensiones:	254 mm (An) x 282 mm (Prf) x 76 mm (Al) (10,0" (An) x 11,1" (Prf) x 3,0" (Al))
Peso:	1,5 kg (3,3 lb)
Equipo opcional:	Adaptador de CA (AD-8000)

### SOFTWARE

Tamaño de los caracteres:	6 tamaños seleccionables (6 puntos a 38 puntos) + Automático Todos disponibles en Estrecho, Medio y Ancho.
Juegos de caracteres:	2 tipos de caracteres incorporados
Tamaño de la memoria intermedia:	Una línea 1m (3,3") ó 255 caracteres Múltiples líneas Múltiples bloques 21 cm (8,3") para cada bloque
Tamaño de la memoria:	1952 caracteres
Número de caracteres:	220 caracteres
Estilos de impresión:	Normal, perfilado, sombra 1, sombra 2, negrilla, cursiva, cursiva y negrilla, cursiva y sombra 1, cursiva y sombra 2, cursiva y perfilado





---

## Brother P-TOUCH Telephone Contact Guide

- For technical and operational assistance call Customer Service at 1-901-373-6256 from 8:00a.m. to 4:30p.m. CST (Central Standard Time).
- To order brochures on other Brother products call 1-800-284-4357.
- To order ribbons and accessories:
  - (1) Contact your local Brother authorized dealer to see whether they carry the ribbon or accessory that you require.
  - (2) To use Visa or Master Card call TOLL FREE 1-800-284-4357, or fax your order to Brother at 1-800-947-1445 anytime.
  - (3) For questions on which ribbons or accessories fit your machine, call 1-800-284-4357 from 9:00a.m. to 4:30p.m. EST (Eastern Standard Time).
  - (4) To order by mail or pay by check, please fill out the accessory order form and mail it along with payment to:

Customer Service  
Brother International Corporation  
P.O. Box 341332  
Bartlett, TN 38133-1332

## List of Factory Authorized Service Depots:

In case of a problem with your Brother machine please contact the Service Depot in your area listed below:

### **BROTHER INTERNATIONAL CORP.**

3131 APPLING ROAD  
BARTLETT, TN 38133-1332  
(901) 373-3375

### **CLEVELAND TYPEWRITER & COMPUTER**

1955 LEE ROAD  
CLEVELAND, OH 44118  
(216) 374-2500

### **DOSSMAN'S OFFICE MACHINES**

4119 MT. VIEW DRIVE  
ANCHORAGE, AK 99504  
(907) 274-5315

### **IRVCO DISTRIBUTING**

2221 HAMMOND AVENUE  
SCHAUMBERG, IL  
60173-3813  
(708) 397-7100

### **MAHR BUSINESS EQUIPMENT**

2746 WEST CAMELBACK ROAD  
PHOENIX, AZ 85017  
(602) 242-6035

### **MODERN BUSINESS MACHINES**

4609 FAIRFIELD STREET  
METARRIE, LA 70006  
(504) 885-5961

### **NEVILL BUSINESS MACHINE COMPANY**

2707 ROYAL LANE  
DALLAS, TX 75229  
(214) 243-5285

### **OMNI TECHNICAL SERVICES**

23182 ALCALDE DRIVE  
SUITE G  
LAGUNA HILLS CA 92653  
(714) 768-6627

### **REM HAWAII OFFICE PRODUCTS**

645 HALEKAUWILA STREET  
HONOLULU, HI 96813  
(808) 537-9575

### **RICHARD'S BUSINESS MACHINES**

10509 AURORA AVENUE  
NORTH  
SEATTLE, WA 98133  
(206) 362-7078

### **ROBBINS BUSINESS MACHINES**

3069 FORT STREET  
LINCOLN PARK, MI 48146  
(313) 386-5080

If you cannot find a local service center, please call 1-800-284-4357 to locate the authorized service center closest to you.

---

**brother**®