



# **P** **USER'S GUIDE**

# **-TOUCH**



**brother**<sup>®</sup>

## INTRODUCTION

Your new P-touch will help you design and print labels for any application. Extremely versatile, it can create characters of many sizes and styles. In addition, with the use of optional tape cassettes, you can print labels with different character and background colors.

You no longer have to worry about rushing tasks that require professional-type printing. The quality and performance of the P-touch make it a very versatile machine.

Although the P-touch is easy to use, we suggest that you read this manual carefully before starting. Please keep the manual in a handy place for future reference.

Good luck! We hope you enjoy using your P-touch.

### FCC NOTICE

This equipment generates and uses radio frequency energy and if not installed and used properly, that is, in strict accordance with the manufacturer's instructions, may cause interference to radio and television reception. It has been type tested and found to comply with the limits for a Class B computing device in accordance with the specifications in Subpart J of Part 15 of FCC Rules, which are designed to provide reasonable protection against such interference in a residential installation. However, there is no guarantee that interference will not occur in a particular installation. If this equipment does cause interference to radio or television reception, which can be determined by turning the equipment off and on, the user is encouraged to try to correct the interference by one or more of the following measures:

- Reorient the receiving antenna
- Relocate the computer with respect to the receiver
- Move the computer away from the receiver
- Plug the computer into a different outlet so that computer and receiver are on different branch circuits.

If necessary, the user should consult the dealer or an experienced radio/television technician for additional suggestions.

# CONTENTS

<b>GENERAL OVERVIEW</b> .....	2
<b>GENERAL PRECAUTIONS</b> .....	4
<b>BEFORE YOU START</b> .....	5
INSERTING A TAPE CASSETTE .....	5
INSERTING BATTERIES .....	6
CHANGING THE CUTTER UNIT .....	7
STARTING .....	8
<b>CREATING A MESSAGE</b> .....	9
DISPLAY .....	9
MOVING THE CURSOR .....	9
CLEARING THE MEMORY .....	10
DIAL INPUT .....	10
CAPITALS .....	11
SPACE KEY .....	12
SYMBOLS .....	13
<b>EDITING A MESSAGE</b> .....	16
DELETING .....	16
OVERTYPING .....	18
INSERTING .....	20
<b>PRINTING A LABEL</b> .....	22
SIZE .....	23
STYLE .....	24
FONT .....	25
PRINTING .....	26
ADVANCING & CUTTING .....	27
<b>MESSAGE LIST</b> .....	28
<b>TROUBLESHOOTING</b> .....	29
<b>SPECIFICATIONS</b> .....	30
<b>ACCESSORIES</b> .....	31
<b>ACCESSORY ORDER FORM</b> .....	32

## GENERAL OVERVIEW

LCD display

ON/OFF key

CODE key

For functions written in green  
you must hold down the CODE key while  
pressing the function key.

Battery compartment latch

Battery compartment

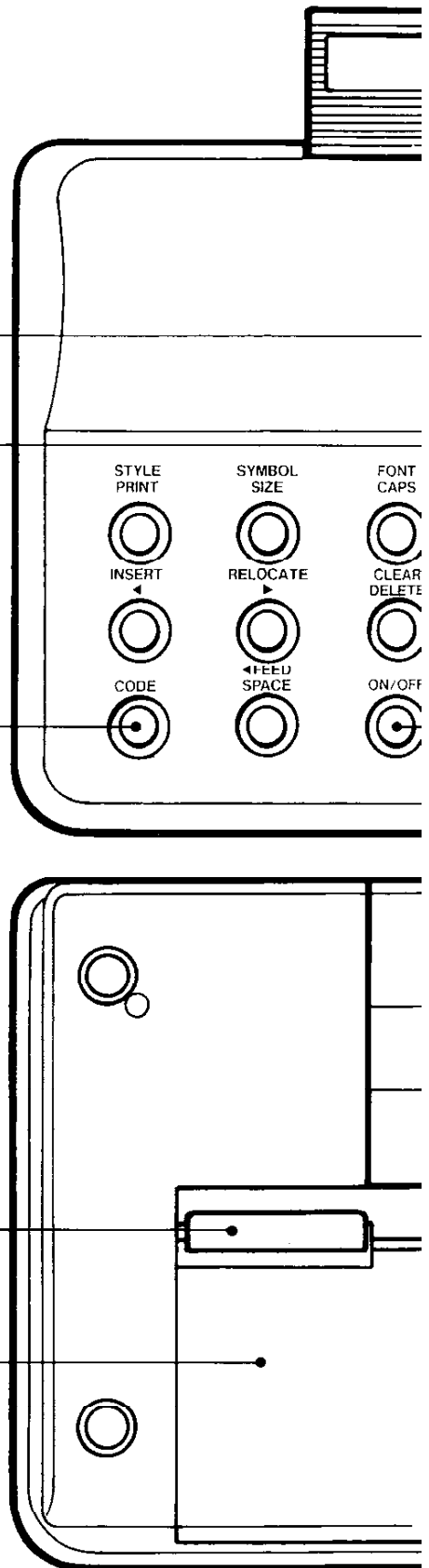

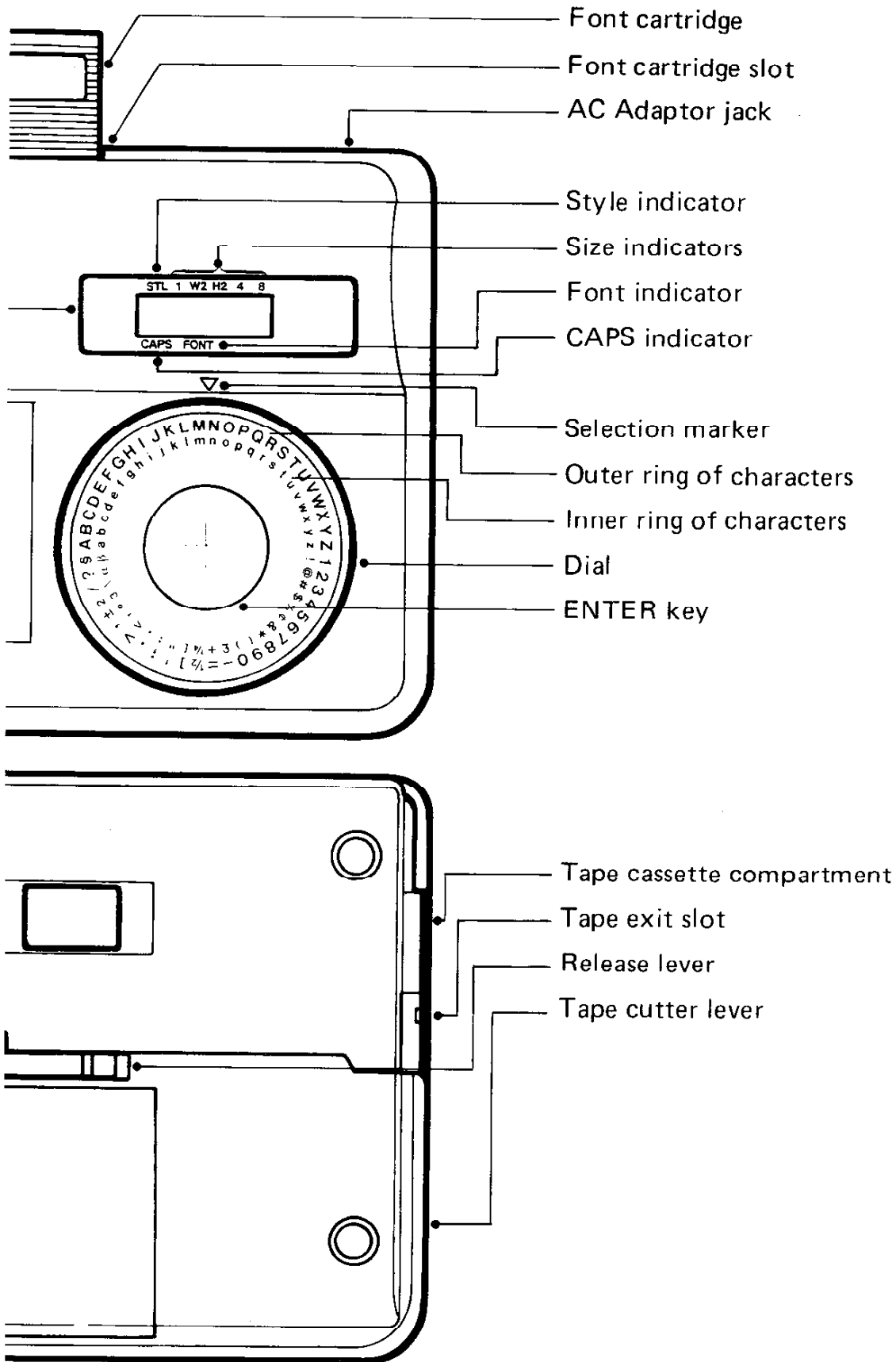

## GENERAL PRECAUTIONS

- Do not clean the machine with alcohol or other organic solvents. Use only a soft, dry cloth.
- Do not put anything onto or into the machine.
- Do not expose the machine to high temperatures or high humidity. Never leave it on the dashboard or in the trunk of your car.
- Do not use the machine in dusty places. Keep it out of both direct sunlight and rain.
- Remove the batteries and/or disconnect the AC Adaptor if you do not intend to use your machine for a long time. (Note: When power is disconnected, the memory will be lost.)
- Do not leave any rubber or vinyl on the machine for an extended period of time. Doing so may cause staining.
- Do not pull on the tape. This may damage the tape cassettes.
- Use only the AC Adaptor, Model AD-20 designed exclusively for the P-touch.
- After inserting the new tape cassette, advance the tape by pressing the CODE key and the ◀ FEED key once.

## BEFORE YOU START

### INSERTING A TAPE CASSETTE

A tape cassette is supplied with this unit.

To insert a new tape cassette:

- (1) Turn the machine over. Remove the tape cassette compartment cover by pressing in the scored portion and lifting.
- (2) If there is an old tape cassette in the compartment, pull up the release lever. Pull the used tape straight up to remove it.
- (3) Remove the stopper from the new tape cassette. If the tape inside the cassette is loose, use your finger to wind it until it is taut.
- (4) Insert the new tape cassette firmly into the compartment. Push down the release lever to lock the tape into place. Replace the compartment cover.
- (5) Advance the tape by pressing the CODE key and the ◀ FEED key once.

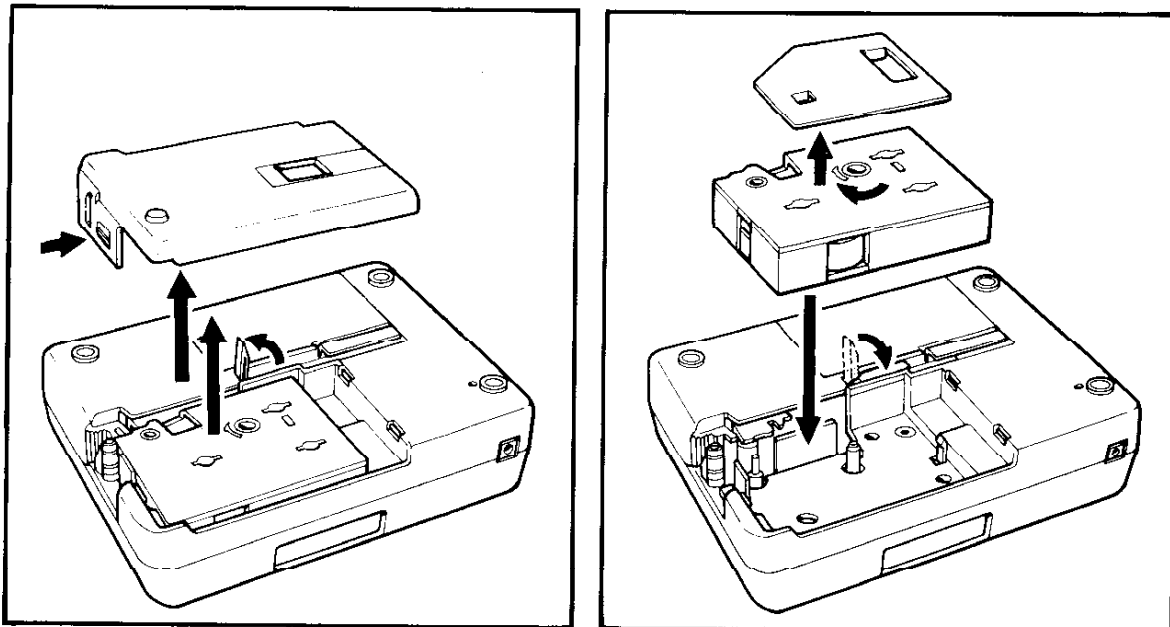

**INSERTING  
BATTERIES**

The machine uses four C-type batteries (not included).

To insert batteries:

- (1) Turn the machine over. Remove the battery compartment cover by pinching the latch and lifting.
- (2) Follow the diagrams on the back of the compartment to insert the batteries in the proper direction.
- (3) After inserting the batteries, re-attach the battery compartment cover.

When "B.WEAK" (Batteries Weak) is displayed, replace the batteries.

An optional AC Adaptor is also available.

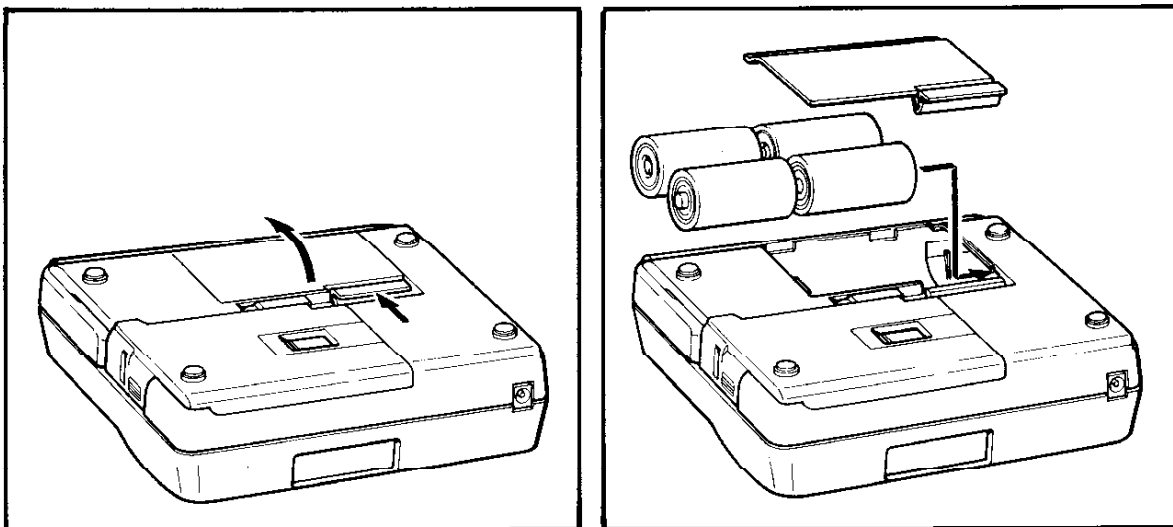



**CHANGING  
THE CUTTER  
UNIT**

Whenever the cutter does not cut well, replace it with a new blade.

To replace a dull or broken blade:

- (1) Turn the machine over. Open the tape cassette compartment cover. Pull up the tape cassette release lever. If a tape cassette is installed, carefully remove it. Push the empty side of the replacement unit down to grasp the old cutter.
- (2) Pull the replacement unit up to remove the cutter.
- (3) Turn the replacement unit over and line up the plastic teeth of the new cutter unit with the teeth on the machine's gear.
- (4) Push the replacement unit down to insert the new cutter into the machine.
- (5) Replace the compartment cover.

Refer to the Accessory Order Form on page 32 for purchasing new blades.

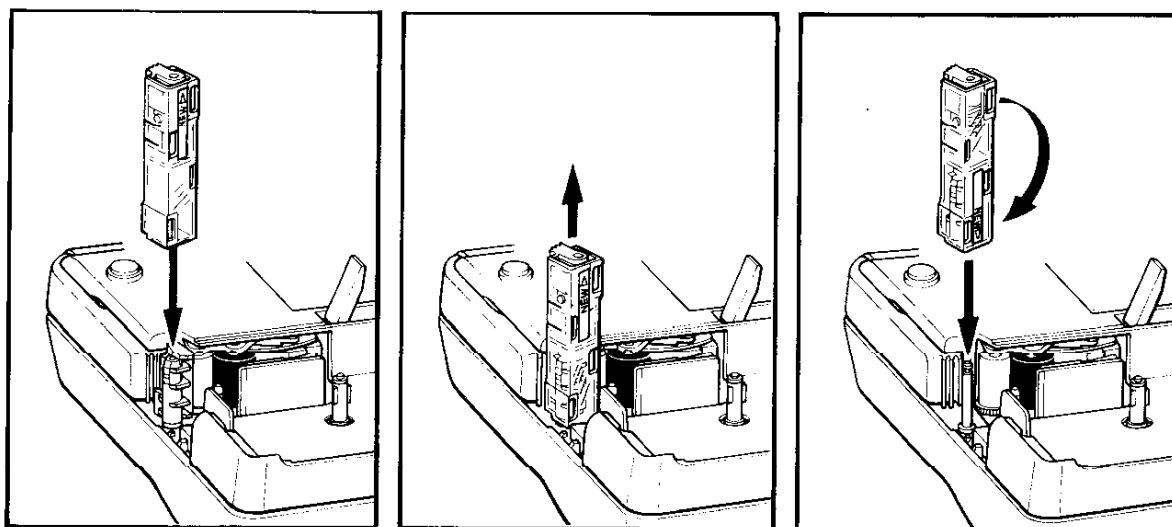

## **STARTING**

**To start the machine:**

**Press the ON/OFF key.**

The machine's internal memory retains the last message created, and displays it when you turn on the machine. This feature allows you to stop work on a message, turn off the machine, and return to it later without having to re-enter the message.

Note: If you remove or replace the batteries, the memory is erased.

The machine has an automatic turn-off feature. If the machine is on, but is not used for five minutes, it will automatically shut off. The message will be retained in memory until the machine is turned on again.

## CREATING A MESSAGE

### DISPLAY

You are now ready to create a message on the machine.

The machine's LCD display is six characters wide. Actually though, you can create messages up to 45 characters in length. The six-character display is like a window which moves across your message.

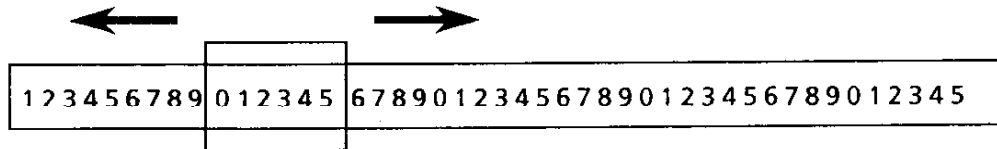

### MOVING THE CURSOR

You can display a different part of your message by moving the cursor backwards and forwards.

To move the cursor through your message:

Press the ◀ and ▶ keys to move the cursor one space at a time.

Press the CODE key and the RELOCATE key to advance the cursor to the end of the message.

Note: You cannot move the cursor if a character is flashing on the display. You can input the character by pressing the ENTER key (See DIAL INPUT), or you can remove it by pressing the DELETE key (See DELETING).

## CLEARING THE MEMORY

Before entering a new message, you will often need to erase an old message.

Press the **CODE** key and the **CLEAR** key to clear the previous message from the memory and the display.

In these boxes, we will work through a sample message, first creating it, then editing it, and finally printing it onto a label.

For the purpose of this example, suppose you are J. Smith, and you want to make a label with your name on it.

**Example** ● Erase any message from the memory by pressing

CODE                      CLEAR  
○                      +                      DELETE  
○                      ○

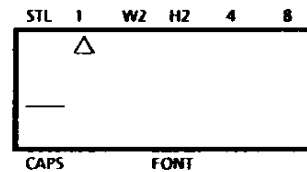

## DIAL INPUT

You can now use the dial to enter a message. Turning the dial allows you to select a character; pressing the **ENTER** key inputs the selected character into the message.

To input characters with the dial:

- (1) Turn the dial until the character you want is aligned with the selection marker at the top of the dial. The character will be flashing above the cursor on the display.

(2) Push the ENTER key. The character stops flashing, and the cursor moves to the right.

Note: If you wish to enter the same character again, just press the ENTER key.

## CAPITALS

The CAPS key is used to select the inner ring or outer ring of characters on the dial. If the CAPS indicator on the display is ON, the outer ring (including capital letters) is selected.

### Example

To input a capital J:

- If the CAPS indicator is OFF, press  to select the outer ring of characters.
- Turn the dial until "J" is aligned with the selection marker. A capital J should be flashing on the left side of the display.

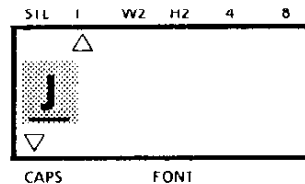

- Push the ENTER key to input the J.

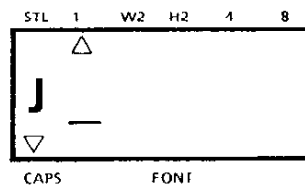

**SPACE KEY**

The SPACE key lets you add a blank space into the message.

Note: The SPACE key and ▶ key have different functions. The ▶ key moves the cursor forward without adding blank spaces.

**Example** To complete the message "J Smith":

- Press  once to add a blank space.

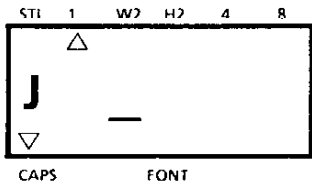

Next, enter the word "Smith":

- Turn the dial to capital S, and input it with the ENTER key.
- Press  to select the inner ring of lower-case characters.
- Enter the letters "mith".

Note: The "J" will move off the display.

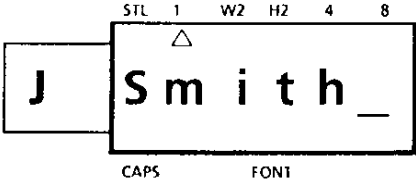

**SYMBOLS**

In addition to the 52 letters, 36 symbols, and 10 numerals on the dial, there are 52 symbols available in Symbol Mode. These 52 additional symbols are arranged into nine groups, corresponding to the numbers 1 to 9 on the dial.

1	á	í	ó	é	ú	¶
2	Ü	ü	Ñ	ñ	Æ	æ
3	≡	∞	∫	∑	×	÷
4	oz.	lb.	ft.	in.	°F	¥
5	fr	2	3	4	5	6
6	7	8	9	↑	↓	→
7	←	↖	↘	↗	↙	★
8	●	·	○	□	⊗	⊕
9	♂	♀	{	}		

To input a symbol that is not on the dial:

- (1) Press the CODE key and the SYMBOL key to enter Symbol Mode.
- (2) Turn the dial to a number from 1 to 9. That number's group of six symbols will be displayed.



**Note:** If the dial is not set from 1 to 9, the display will read "NO SYM".

(3) Move the cursor to the symbol you want.

(4) Press the ENTER key.

Note: If a character is flashing on the display, the machine cannot enter Symbol Mode. You can input the flashing character by pressing the ENTER key, or you can remove it by pressing the DELETE key (See DELETING).

Example To add a star (★) to the message, changing the message to "J Smith★":

- Enter Symbol Mode by pressing  + 
- Select the seventh character group by setting the dial to 7.

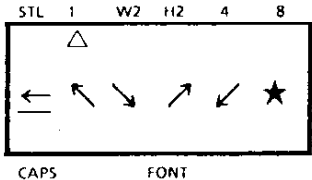

The diagram shows a control panel with a grid of symbols. The top row has labels: STL 1, W2, H2, 4, 8. The symbols in the grid are: a triangle (△) in the top-left cell, a left arrow (←) in the second cell, a left arrow (←) in the third cell, a right arrow (→) in the fourth cell, a left arrow (←) in the fifth cell, and a star (★) in the sixth cell. Below the grid, the labels "CAPS" and "FONT" are visible.

- Move the cursor to ★ by pressing 

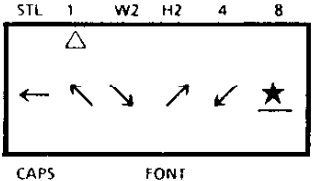

The diagram shows the same control panel as above, but with a small triangle cursor pointing to the star symbol (★) in the sixth cell of the grid.



- Push the ENTER key to input a ★ .

The message should now look like this:

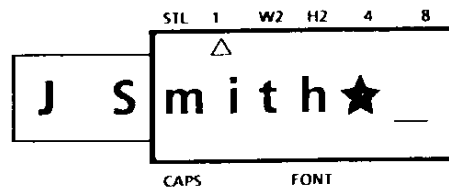

After a non-dial symbol has been entered, the machine automatically exits from Symbol Mode. If you wish to enter another symbol, you must re-enter Symbol Mode by pressing the CODE key and the SYMBOL key.

## EDITING A MESSAGE

### DELETING

The DELETE key allows you to remove characters from your message.

To delete a character:

- (1) Using the ◀ and ▶ keys, position the cursor one space to the right of the character you want to delete.
- (2) Press the DELETE key.

All characters following the deletion (including blank spaces) move one space to the left.

The DELETE key has one other function. If there is a flashing character above the cursor, you can press the DELETE key to remove it.

**Example**

To delete the ★ from the message:

- Make sure the cursor is positioned to the right of the ★.

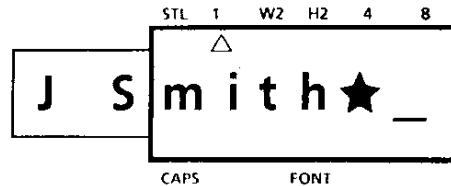

- Press  CLEAR DELETE to remove the ★.

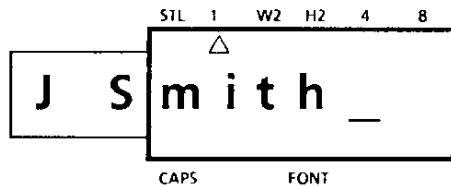

Now we will delete the blank space:

- Press  INSERT until the cursor is positioned to the right of the blank space (under the "S").

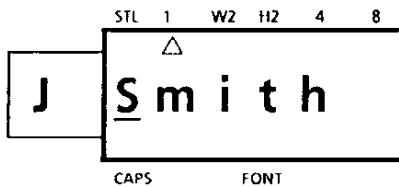

- Press  CLEAR DELETE to remove the blank space.

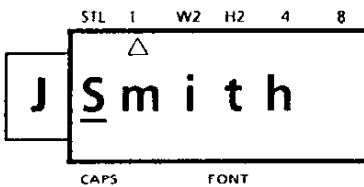

- Press  INSERT to adjust the display in order to check that the blank space has been deleted.



The machine normally operates in Overtyping Mode. In Overtyping Mode, you can change a character simply by typing a new one in its place.

To type over a character:

- (1) Move the cursor to the character you want to change.**
- (2) Choose the character or symbol you want.**
- (3) Press the ENTER key.**

The new character will take the place of the old one in the message.

Example

To replace the lower-case letters "mith" with capital letters:

- Position the cursor under the "m".

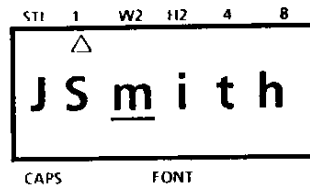

- Switch to Capital Mode.
- Turn the dial to capital M.
- Press the ENTER key.

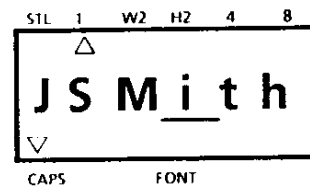

- Repeat the process for the letters "ITH".

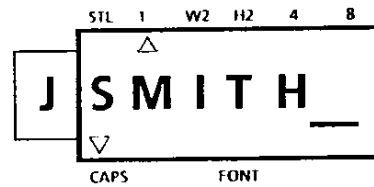

## INSERTING

Sometimes you may want to insert a character into the middle of your message. To do so, you must change from Overtyping Mode to Insert Mode.

To insert characters:



- (1) Move the cursor to the position where you want to insert.
- (2) Press the CODE key and the INSERT key to enter Insert Mode.
- (3) Choose the character or symbol you want, and press the ENTER key.

All characters following the insertion will move one space to the right.

**Example** Insert a period into the message, changing it to "J. SMITH".

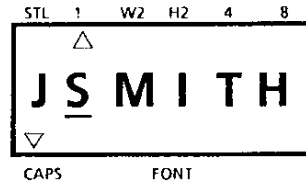
- Position the cursor under the "S".



- Enter Insert Mode by pressing  + 
- Turn the dial to the period.
- Press the ENTER key.

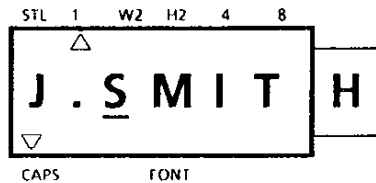

You can leave Insert Mode by advancing the cursor to the end of the message. When you leave Insert Mode, you automatically return to Overtyping Mode.

To leave Insert Mode:

Move the cursor to the end of the message by pressing the CODE key and the RELOCATE key.

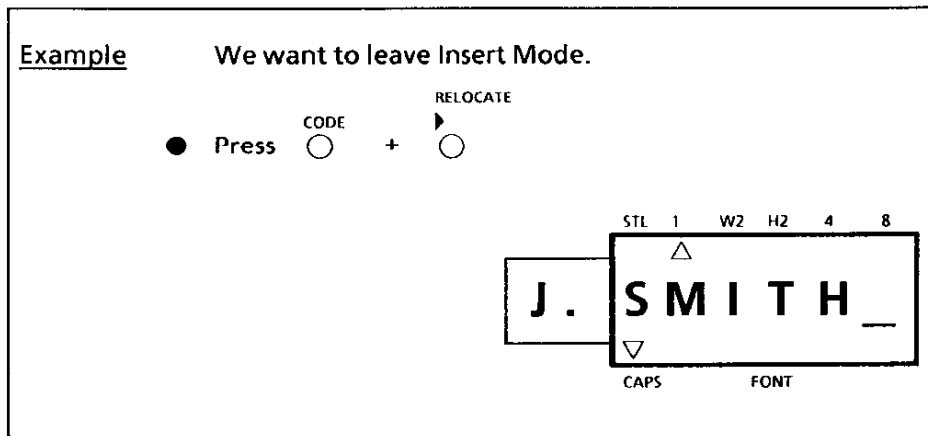

## PRINTING A LABEL

You can print your completed message using a variety of different character sizes, styles, and fonts.

Choose character size, style, and font before printing the label.

Note: The type of character you choose will be used for all the characters in your message. It is not possible to have two different character sizes, styles or fonts within one message.

Examples of various print styles:

Standard Size Normal

J . SMITH

Double Width Normal

J . SMITH

Double Height Normal

J . SMITH

Double Width & Double Height Normal

J . SMITH

4×Width & Double Height Normal

J . SMITH

4×Width & Double Height Outline

J . SMITH

4×Width & Double Height Bold

J . SMITH

4×Width & Double Height Shadow

J . SMITH



**SIZE**

There are five different character sizes you can select for your label:

- 1 - Standard Size
- W2 - Double Width
- H2 - Double Height
- 4 - Double Width & Double Height
- 8 - 4 x Width & Double Height

Press the SIZE key to change the character size and advance the size indicator on the display in the following order:

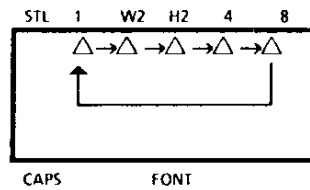

Example

We want to use Double Width and Double Height (4) characters.

- Press  until the size indicator is aligned with the 4.

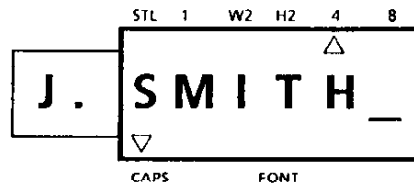

## STYLE

There are also four different print styles:

- 1 – Normal
- 2 – Outline (O.LINE)
- 3 – Bold
- 4 – Shadow

To choose the print style for your label:

- (1) Holding down the CODE key, press the STYLE key once. The display will show the current print style.
- (2) Still holding down the CODE key, press the STYLE key again. The print style changes in the order listed above.
- (3) When the style you want is displayed, release the CODE key.

If you select a style other than Normal, the style indicator will be visible on the display.

Example      We want to use Outline print:

- Hold down  CODE
- Press  STYLE PRINT until the display reads "O.LINE".
- Release  CODE

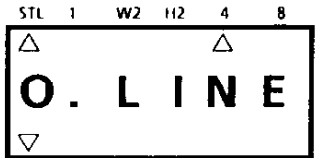

STL 1 W2 H2 4 8

O . L I N E

△ △

▽

CAPS FONT

## FONT

Normally, the machine prints labels with Standard Brougham type font. But, if you wish, you can make labels with different type fonts using an optional font cartridge.

To choose a different type font:

- (1) Turn off the machine by pressing the ON/OFF key. Your message will be retained in memory.
- (2) Insert a font cartridge firmly into its slot in the back of the machine.
- (3) Turn the machine back on.
- (4) Press the CODE key and the FONT key to choose the cartridge's type font. The font indicator will appear on the display.

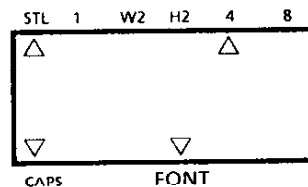

Notes: Make sure to turn off the machine before inserting the cartridge.

If a font cartridge is inserted but the font indicator is not displayed, the normal Brougham type font will be used.

**PRINTING**

After you have chosen the character size, print style, and type font, you are ready to print the label.

To print a label:

Press the PRINT key.

The printed label comes out of the tape exit slot on the side of the machine.

Notes: Any character flashing on the display is not printed on the label. It is erased from the memory during printing.

If 12 or less Standard Size characters are printed, the tape will not protrude from the exit slot.

Example

We are now ready to print our message onto a label:

- Print the message by pressing  .

A label reading "J.SMITH" written in Double Width & Double Height Outline characters will be printed.

**ADVANCING  
& CUTTING**

Not all of the printed label comes out of the machine after printing, so you must advance the tape before cutting. If you do not advance the tape, the end of the message will be cut off.

To advance the tape:

Press the CODE key and the ◀ FEED key.

To cut the tape:

Pull out the tape cutter lever on the side of the machine.

Notes: If you pull out the tape cutter lever too far, it may break. Be careful not to pull it past the line on the lever.

Do not pull on the tape. This may damage the tape cassettes.

Do not cut the tape while printing or feeding.

Example We want to advance and cut the label:

- Press CODE + ◀ FEED SPACE
- Cut the label by pulling out the tape cutter lever.

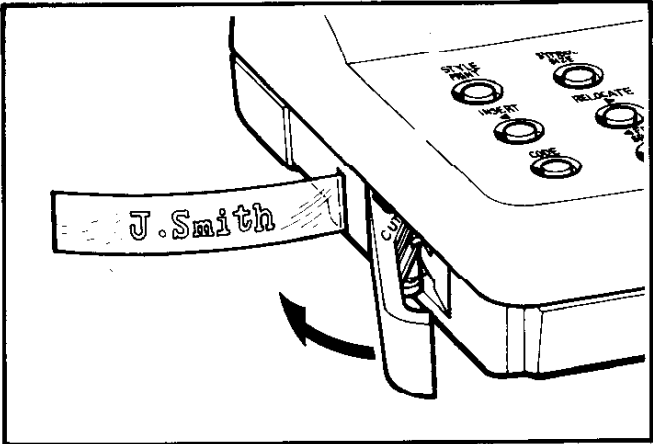

## MESSAGE LIST

<b>ERROR</b>	Input error.
<b>B.WEAK</b>	The batteries are weak.
<b>M.FULL</b>	The memory is full. (max:45 characters)
<b>NO SYM</b>	The dial is not set to 1-9 in Symbol Mode.
<b>NORMAL</b>	See page 24.
<b>O. LINE</b>	
<b>BOLD</b>	
<b>SHADOW</b>	
<b>CG ERR</b>	The font cartridge is not inserted properly. If this message appears when printing, turn the power off, reinsert the cartridge properly, select the FONT and print again.

## TROUBLESHOOTING

Problem	What to Do
1. The display stays blank after you have turned on the machine.	<ul style="list-style-type: none"><li>● Check the polarity of the batteries.</li><li>● If the batteries are low, replace them.</li></ul>
2. The machine does not print, or the printed characters are blurred.	<ul style="list-style-type: none"><li>● Check that the tape cassette has been inserted properly.</li><li>● If the tape cassette is empty, replace it with a new one.</li><li>● Make sure that the release lever has been closed properly.</li></ul>
3. The printed characters are not formed properly.	<ul style="list-style-type: none"><li>● The batteries are probably weak. Replace them.</li></ul>
4. The tape cannot be cut.	<ul style="list-style-type: none"><li>● The cutting blade is probably dull. Replace the blade.</li></ul>

## SPECIFICATIONS

<b>Input Device:</b>	Dial 10 keys
<b>Print Speed:</b>	12 cps (standard size)
<b>Character Size:</b>	Standard Size Double Width Double Height Double Width & Double Height 4 x Width & Double Height
<b>Internal Character Generator:</b>	Standard Character Font: (Standard Size, Double Width) Enlarged Character Font: (Double Height, Double Width & Double Height, 4 x Width & Double Height) Font: Brougham (150 characters)
<b>Print Tape:</b>	Sticker type: 12 mm (W)
<b>LCD:</b>	7 x 5 dots 1 line x 6 columns 1/8 duty
<b>Optional Equipment:</b>	Font Cartridge Font: Anelia PS (150 characters) Lori PS (150 characters)
<b>Power Supply:</b>	Batteries (C-type x 4) or optional AC Adaptor (Rated Voltage 6 V 1.2 A) The power automatically turns off when no key is pushed or the dial is not turned for five minutes.
<b>Dimensions:</b>	6.69" (W) x 5.04" (D) x 2.21" (H)
<b>Weight:</b>	1.76 lb (including batteries)
<b>Memory Buffer Size:</b>	45 characters



## ACCESSORIES

- **Supplies**

Obtain tape cassettes, font cartridges, AC Adaptors and tape cutters from your nearest authorized dealer. Brother cannot be held responsible for trouble caused by the use of unauthorized supplies.

- **Font cartridge samples**

Anelia PS

ABCDEFGHIJKLMNOPQRSTUVWXYZ

abcdefghijklmnopqrstuvwxyz 1234567890

Lori PS

ABCDEFGHIJKLMNOPQRSTUVWXYZ

abcdefghijklmnopqrstuvwxyz 1234567890

- **Tapes**

- Black Characters on Clear Adhesive
- Black Characters on White Adhesive
- Red Characters on Clear Adhesive
- Red Characters on White Adhesive
- Blue Characters on Clear Adhesive
- Blue Characters on White Adhesive
- Gold Characters on Clear Adhesive
- Gold Characters on Black Adhesive

- **Others**

- AC Adaptor for P-touch
- Replacement Tape Cutter

Dear Customer:  
 Please use this order form when  
 ordering accessories for your  
 P-touch. To charge your order,  
 call Toll Free 1-800-284-HELP.  
 Telephone hours are Monday  
 through Friday, 9:00 a.m. to 4:30  
 p.m. (EST)

## ACCESSORY ORDER FORM

	Stock No.	Description	Price	Quantity	Total
Accessories	AD-20	AC Adaptor for P-touch	\$ 19.95		
	TC-8	Replacement Tape Cutter	\$ 9.95		

Font Cartridge	FC-15	Font Cartridge (Anelia PS)	\$ 29.95		
	FC-25	Font Cartridge (Lori PS)	\$ 29.95		

Tape Cassette	TC-10	2 Tape Cassettes (Black characters on clear adhesive - 2pcs.)	\$ 34.95		
	TC-20	2 Tape Cassettes (Black characters on white adhesive - 2pcs.)	\$ 34.95		
	TC-30	3 Tape Cassettes (Red characters on clear adhesive) (Blue characters on clear adhesive) (Gold characters on clear adhesive)	\$ 49.95		

Stock No.	Description	Price	Quantity	Total
TC-40	3 Tape Cassettes (Red characters on white adhesive) (Blue characters on white adhesive) (Gold characters on black adhesive)	\$ 49.95		
Sub Total				
CA, GA, IL, LA, NJ, NY, SC, TX, VA Residents - Add Applicable Sales Tax				
Shipping / Handling				\$ 2.00
TOTAL				

SHIPPING LABEL	METHOD OF PAYMENT (CHECK ONE)
Brother International Corporation Consumer Products Division P.O. Box 159, Piscataway, NJ 08855-0159 (Please Type or Print Clearly)	<input type="checkbox"/> CHECK OR MONEY ORDER <input type="checkbox"/> ENCLOSURE Please charge my <input type="checkbox"/> VISA <input type="checkbox"/> MASTER CARD \$15.00 minimum for credit card orders (Sorry, no C.O.D.'s)
Name _____	Account number _____
Address _____	Expiration Date _____
City _____	Signature _____
State / Zip _____	Daytime Phone # (    ) _____

Prices Subject To Change Without Notice

