

With your PT-D200, you can create labels for multiple applications. Select from the many frames, character sizes and styles to design beautiful custom labels. In addition, the variety of tape cartridges available allows you to print labels with different widths and exciting colors.

Printed in China LAAT23001A



Safety Precautions

WARNING

- Indicates a potentially hazardous situation which, if not avoided, could result in death or serious injuries. Follow these guidelines to avoid the risk of fire, burns, injury, electric shocks, rupture, overheating, abnormal odours or smoke.

Read this manual carefully before starting and keep the manual in a handy place for future reference.

CAUTION

Follow these guidelines to avoid personal injury, liquid leakage, burns or heat.

- When the P-touch labeler is not being used, store it out of the reach of children. Do not allow children to put the P-touch labeler parts or labels in their mouths.

General Precautions

- Depending on the location, material, and environmental conditions, the label may unpeel or become removable, the color of the label may change or be transferred to other objects.

Do not place the labeler/batteries/AC adapter in direct sunlight or rain, near heaters or other hot appliances...

FCC NOTICE

This device complies with Part 15 of the FCC Rules. Operation is subject to the following two conditions: (1) this device may not cause harmful interference...

BASIC USAGE

Entering Text

Switching Upper Case/Lower Case, Making Two Lines of Text, Entering Accented Characters, Changing Label Length

NOTE, Entering Tab, Entering Margin, Setting Margin

Printing Labels

Preview, Feeding (Tape Feed), Printing, Using Print Options

NOTE, [Numbering], [Mirror]

Initial Settings, Start your machine, Set the language

NOTE, [Numbering], [Mirror]

Saving Label Files

Save, Print, Open, NOTE

USING TEMPLATES

Name Label

Bill Anderson ABC Company, Inc., Deco Mode

NOTE, Entering Margin, Setting Margin

USEFUL FUNCTION KEYS

Font Key

Font, Select an item

2 Press

Table with Font, Size, Width, Style columns and corresponding icons for various settings like Helsinki, Large, Normal, Bold, etc.

NOTE, [Numbering], [Mirror]

Frame Key

Select a frame, NOTE

DECO MODE

Bill Anderson ABC Company, Inc., Deco Mode

- To exit the DECO MODE or Name Label function and return to the text input screen, do one of the following:

Symbol Key

Select various symbols, Select category

NOTE

Short Cut Keys

Table with Language, Label Length, Margin, Name Label, File, Tab, Tab Length, Clear, Unit columns and corresponding icons.

Resetting the P-touch

- You can reset the P-touch labeler when you want to initialize the settings, or in the event the P-touch labeler is not working properly.

Should you encounter any problems with your product, please do not return your product to the store!

Declaration of Conformity

We, BROTHER INDUSTRIES, LTD 15-1, Naeshiro-cho, Mizuho-ku, Nagoya, 467-8561, Japan declare that this product is in compliance with the essential requirements and other relevant provisions of Directives 2004/108/EC and 2009/125/EC.

Power Supply and Tape Cassette

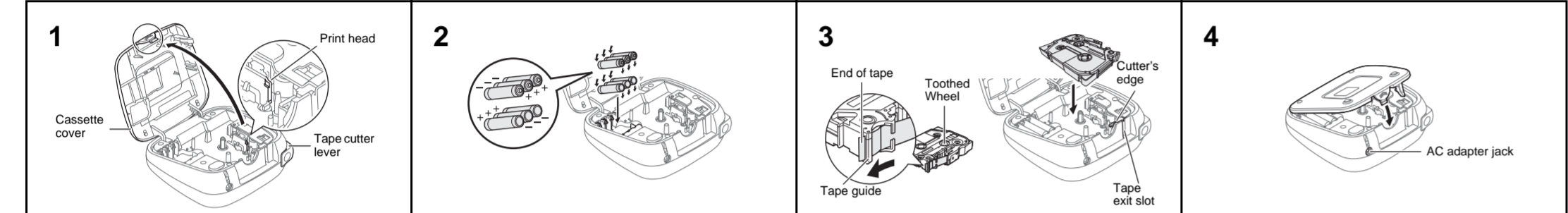

Open the cassette cover by pressing the above indicated area at the top end of the machine.

Insert six new AAA alkaline batteries (LR03) or fully charged Ni-MH batteries (HR03), making sure that their poles point in the correct directions.

Insert a tape cassette, making sure that it snaps into place.

Securely close the cassette cover, making sure that it snaps into place.

LCD Display & Keyboard

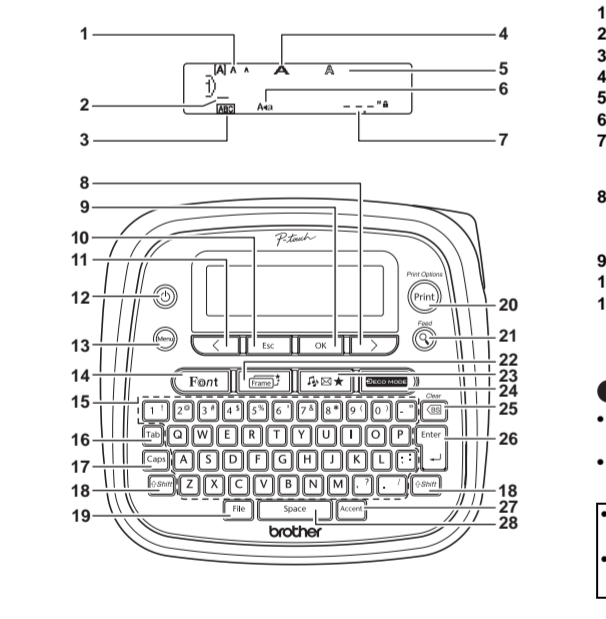

- 1. Size 2. Cursor 3. Underline/Frame 4. Width 5. Style 6. Caps 7. Label Length

NOTE: The LCD shows one row of 15 characters; however, the text that you enter can be up to 80 characters in length.

Specifications

Dimensions: (W x D x H) Approx. 6.49" x 6.10" x 2.67" (Approx. 165(W) x 155(D) x 68(H)mm)

Power supply: Six AAA alkaline batteries (LR03) Six AAA Ni-MH batteries (HR03)*1 Optional AC adapter (AD-24ES)

Initial Settings

- 1 Start your machine. 2 Set the language. 3 Set the unit of measurement.

Troubleshooting

Table with Message, Cause/Remedy columns. Includes messages like Low Battery!, Battery Dead, Invalid!, No Text!, Line Limit!



Table with Message, Cause/Remedy columns. Includes messages like No Cassette!, Cutter Error, Text Full!, Text Limit!, No Frame OK?, OK to Feed?, Insert 0.47", Wrong Tape!



What to do when...

Table with Problem, Solution columns. Includes problems like display stays blank, power turns off, tape does not feed, blank horizontal line.

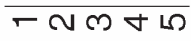







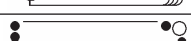









Table with Problem, Solution columns. Includes problems like machine has 'locked up', power turns off, tape does not feed, All text and format settings need to be cleared.

















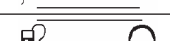

D







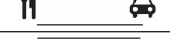





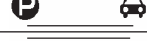

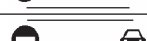
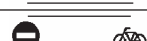

1	 Bill Anderson ABC Company, Inc.
2	 Bill Anderson ABC Company, Inc.
3	 Bill Anderson ABC Company, Inc.

4	 Bill Anderson ABC Company, Inc.
5	 Bill Anderson ABC Company, Inc.
6	 Bill Anderson ABC Company, Inc.











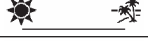

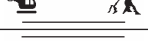
E



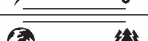







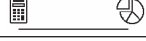

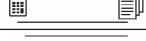
2	12345 
3	
4	
5	
6	
7	
8	
9	
10	
11	
12	
13	
14	
15	
16	
17	
18	
19	
20	









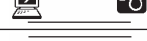
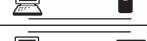

21	
22	
23	
24	
25	
26	
27	
28	
29	
30	
31	
32	
33	
34	
35	
36	
37	
38	
39	
40	

41	
42	
43	
44	
45	
46	
47	
48	
49	
50	
51	
52	
53	
54	
55	
56	
57	
58	
59	
60	

E

61	
62	
63	
64	
65	
66	
67	
68	
69	
70	
71	
72	
73	

74	
75	
76	
77	
78	
79	
80	
81	
82	
83	
84	
85	
86	

87	
88	
89	
90	
91	
92	
93	
94	
95	
96	
97	
98	
99	

F

Helsinki	ABC\$£€39
Brussels	ABC\$£€39
US	ABC\$£€39
Florida	ABC\$£€39
Belgium	ABC\$£€39
San Diego	ABC\$£€39
Los Angeles	ABC\$£€39

Calgary	<i>ABC\$£€39</i>
HEL + Atlanta	ABC\$£€39
HEL + Adams	ABC\$£€39
HEL + Brunei	ABC\$£€39
HEL + Istanbul	ABC\$£€39
HEL + Sofia	ABC\$£€39
HEL + Germany	ABC\$£€39