

Ages 6 & u

P-TOUCH

Stickerkid™

Model ST-5

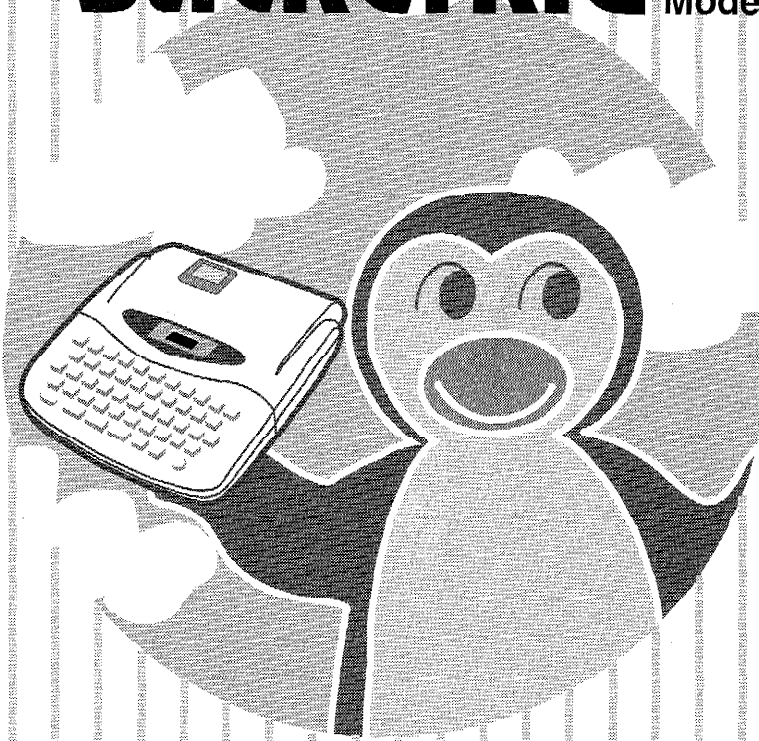

● GUIDE BOOK ●

- Read this guidebook before you start using your P-TOUCH Stickerkid.
- Keep this guidebook in a safe place, so you won't lose it.

brother®

FCC NOTICE

This equipment has been tested and found to comply with the limits for a Class B digital device, pursuant to Part 15 of the FCC Rules. These limits are designed to provide reasonable protection against harmful interference in a residential installation. This equipment generates, uses, and can radiate radio frequency energy and, if not installed and used in accordance with the instructions, may cause harmful interference to radio communications. However, there is no guarantee that interference will not occur in a particular installation. If this equipment does cause harmful interference to radio or television reception, which can be determined by turning the equipment off and on, the user is encouraged to try to correct the interference by one or more of the following measures:

- Reorient or relocate the receiving antenna
- Increase the separation between the equipment and receiver.
- Connect the equipment into an outlet on a circuit different from that to which the receiver is connected.
- Consult the dealer or an experienced radio/television technician for help.

- This product conforms to the safety requirements of ASTM F963.

- This product is designed for children, ages 6 and up.

▲ CAUTION

- *Watch out for smaller children. Don't let them put the yellow cutter in their mouth.*
- *This product contains a sharp yellow tape cutter. Only adults should replace the cutter.*

- Don't spill food or drinks on it. The Stickerkid is not waterproof.



- Don't touch the print head with your finger. It can break easily.

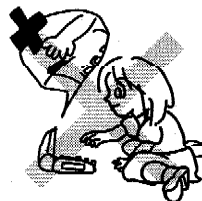

- Don't push on the LCD display.



- Don't use the cutter lever while the machine is printing or feeding the label. Wait until the machine stops feeding the label.

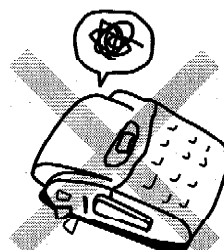

- Don't print out a label if the cassette is empty or if there is no cassette in the Stickerkid.

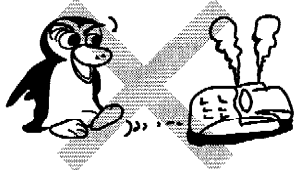

- Don't pull too hard on the cutter lever.



- Don't leave the Stickerkid in very hot places for a long time, like in a car, near a heater or in the sunlight.

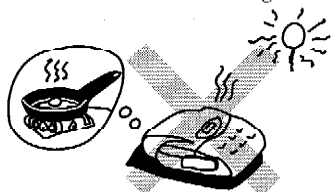

- Don't pull on the labels that come out of the machine.

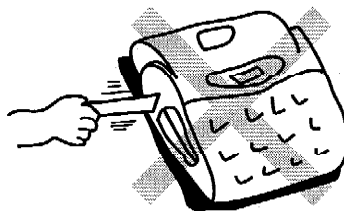

CONTENTS

GET READY!

IMPORTANT PARTS OF THE STICKERKID	1
THE STICKERKID'S DISPLAY	2
THE STICKERKID'S KEYBOARD	3

GET SET!

HOW TO PUT IN THE BATTERIES	5
HOW TO PUT IN OR CHANGE THE TAPE CASSETTE	6

NOW, LET'S GO!

HOW TO TEACH THE STICKERKID YOUR NAME	7
HOW TO MAKE A LABEL	10
TYPE IN THE LETTERS	10
PRINT THE LABEL	11
STICK ON THE LABEL	12
CLEAR THE DISPLAY	13
HOW TO CHANGE A LABEL	14
TYPE IN ONLY CAPITAL LETTERS	14
CHANGE THE LABEL	15
HOW TO MAKE A LABEL WITH PICTURES	17
CHOOSE THE FIRST PICTURE	17
TYPE IN THE LETTERS	19
CHOOSE THE SECOND PICTURE	19
HOW TO USE SYMBOLS & A DIFFERENT FONT	21
CHOOSE A SYMBOL	21
TYPE IN THE LETTERS	22
CHOOSE THE SAME SYMBOL AGAIN	22
CHANGE THE FONT	22
HOW TO USE A DIFFERENT STYLE	24
TURN OFF CAPS	24
TYPE IN THE LETTERS	24
CHANGE THE FONT	26
CHANGE THE STYLE	27
MOVE THE CURSOR	27
CHOOSE A PICTURE	28
HOW TO CHANGE THE MARGINS & PUT IN A FRAME	30
CHANGE THE STYLE	30
CHANGE THE MARGINS	31

TYPE IN THE LETTERS	32
MOVE THE CURSOR	32
CHOOSE A FRAME	33
HOW TO CHOOSE A PHRASE	35
CHOOSE THE PHRASE	36
CHOOSE THE LANGUAGE	36
PRINT THE LABEL	37
HOW TO MAKE A RIBBON	38
CHOOSE THE PATTERN	38
CHOOSE THE RIBBON LENGTH	39
PRINT THE LABEL	39
HOW TO MAKE A PICTURE	40
TYPE IN THE LETTERS	40
MOVE THE CURSOR	41
CHOOSE A FRAME	41
MOVE THE CURSOR AGAIN	41
MAKE A PICTURE	42
HOW TO MAKE A SECRET MESSAGE	44
TURN OFF CAPS	44
TYPE IN THE MESSAGE	44
ENCODE THE SECRET MESSAGE	45
CHANGE THE FONT	45
DECODE THE SECRET MESSAGE	46
HOW TO MAKE GIANT LABELS	48
TYPE IN THE LETTERS	49
CHANGE THE FONT	49
CHANGE THE STYLE	49
PRINT THE GIANT LABEL	49
PUT TOGETHER THE LABEL	50
HOW TO PRINT WITH TWO OR THREE COLORS	52
TURN OFF CAPS	52
TYPE IN THE LETTERS	52
MOVE THE CURSOR	52
CHOOSE A FRAME	53
CHOOSE THE COLORS	53
PRINT THE LABEL	55
HOW TO PLAY THE FAST FINGER GAME	59
TYPE IN YOUR NAME	59
CHOOSE THE LEVEL	60
PLAY THE GAME	61
PLAY THE GAME AGAIN	62

LOOK WHAT THE KEYS CAN DO!	63
FONT KEY	63
STYLE KEY	64
FRAME KEY	67
MARGIN KEY	70
PICTURE KEY	74
MAKE PICTURE KEY	77
LANGUAGE MASTER KEY	85
SECRET CODE KEY	86
MAKE RIBBON KEY	88
MUSIC KEY	91
ERASE/CLEAR ALL KEY	92
FRENCH ACCENTED LETTER KEY	92
SPANISH ACCENTED LETTER KEY	94
SYMBOL KEY	95
PUNCTUATION MARK KEYS	96
SHIFT/CAPS KEY	96
MULTI-COLOR PRINTING KEYS	97
LEFT KEY	97
RIGHT KEY	98
PRINT/GIANT PRINT KEY	98
CODE KEY	100
SPACE/FEED KEY	100
FAST FINGER GAME KEY	100
YES KEY	101
NO KEY	101
ON/OFF KEY	101
RESETTING THE MACHINE	101
HOW TO CHANGE THE CUTTER	103
CLEANING THE PRINT HEAD AND ROLLERS	105
TROUBLESHOOTING	107
SPECIFICATIONS	108
INDEX	109
SUPPLIES	112

¡PREPARETE!

PARTES IMPORTANTES DEL STICKERKID	120
EL VISUALIZADOR DEL STICKERKID	121
EL TECLADO DEL STICKERKID	122

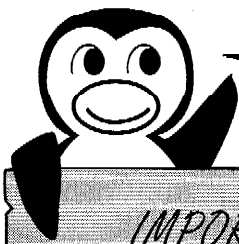

GET READY!

IMPORTANT PARTS OF THE STICKERKID

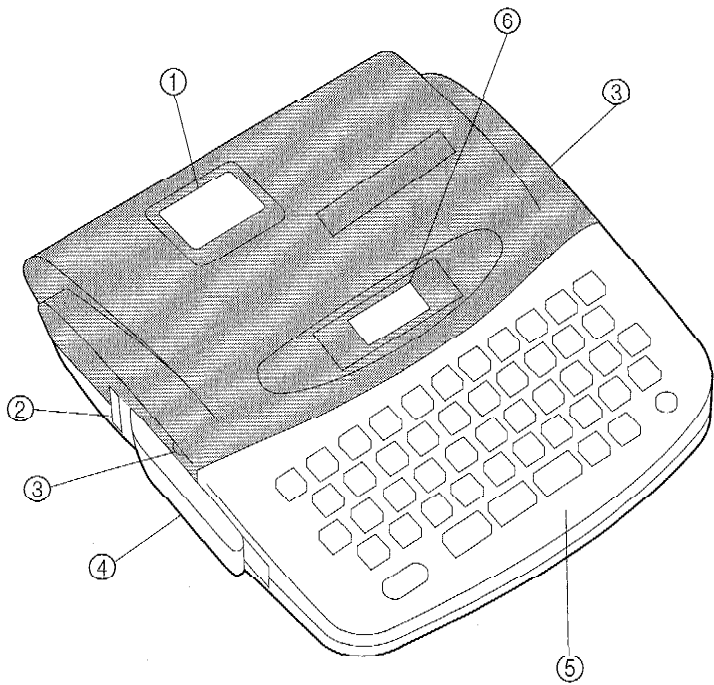

- ① **Cassette window** ... Look through it to see how much tape is left and what kind of tape it is.
- ② **Exit slot** This is where your label comes out.
- ③ **Cassette cover tabs** .. Use these to lift up the cassette cover to change the cassette.
- ④ **Cutter lever** Use it to cut the label.
- ⑤ **Keyboard** Push the keys to type in your label and do lots of other things.
- ⑥ **Display** Look at it to see what you are typing in.



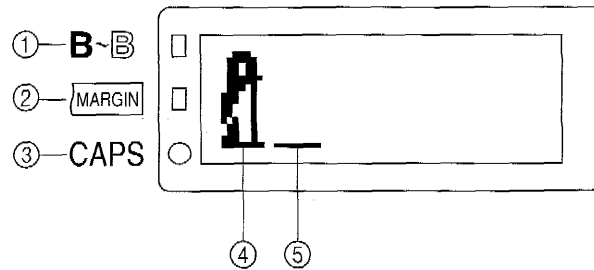

- ① **Style indicator** ... This little square comes on when you change the way the letters in your label are printed. (The different ways of printing letters are called "styles".)
- ② **Margin indicator** ... This little square comes on when you change the size of the empty space on both sides of your label. (The empty spaces on the sides of the label are called "margins".)
- ③ **Capital letter indicator** ... This little circle comes on when all the letters that you type in are capital letters.
- ④ **Penguin** You can see the penguin at the beginning of the letters.
- ⑤ **Cursor** This little flashing line in the letters shows you where you are.



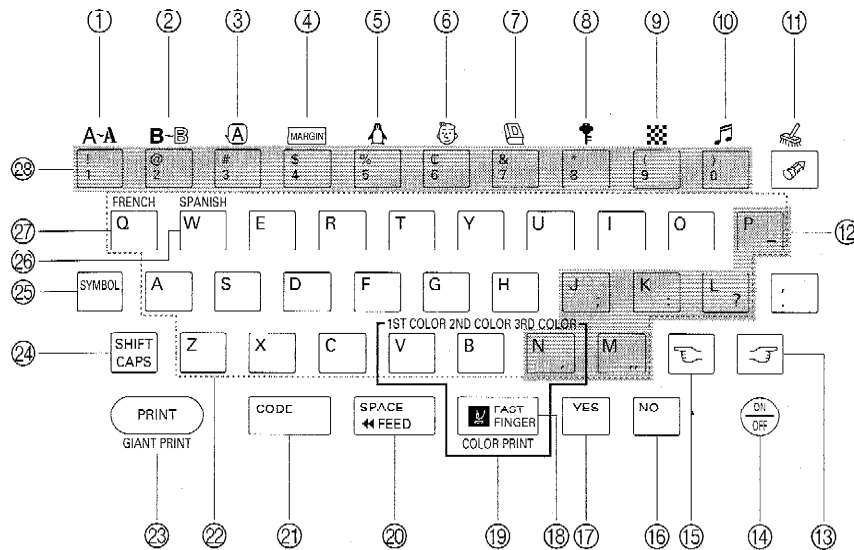
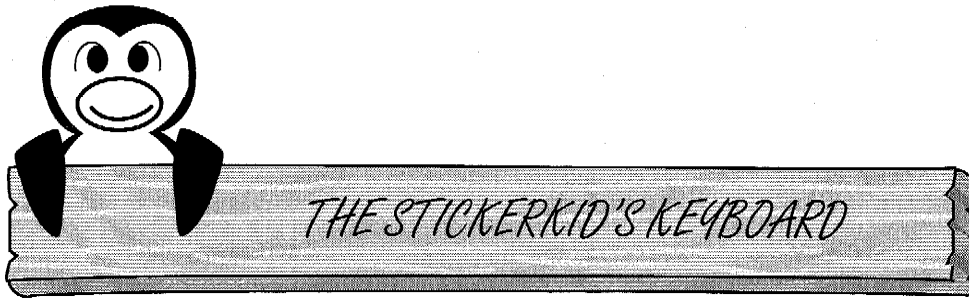

- ① **Font key** For changing the kind of letters used in your label Go to pages 21 and 63.
- ② **Style key** For changing the way the letters are printed on your label Go to pages 24 and 64.
- ③ **Frame key** For putting a frame around things in your label Go to pages 30 and 67.
- ④ **Margin key** For making the empty spaces on the sides bigger or smaller Go to pages 30 and 70.
- ⑤ **Picture key** For putting pictures in your label Go to pages 17 and 74.
- ⑥ **Make picture key** .. For making a picture by putting together a face and a head or a head and a body Go to pages 40 and 77.



- ⑦ **Language master key** ... For choosing a phrase in another language ☞ Go to pages 35 and 85.
- ⑧ **Secret code key** For reading or writing a label in a secret code ☞ Go to pages 44 and 86.
- ⑨ **Make ribbon key** ... For making a label with a pattern on it to decorate things ☞ Go to pages 38 and 88.
- ⑩ **Music key** For turning the music on or off ☞ Go to page 91.
- ⑪ **Erase/Clear all key** For taking out a letter or picture from the text or getting rid of your label ☞ Go to pages 10, 14 and 92.
- ⑫ **Punctuation mark keys** ... For typing in the pink marks that are on some of the keys ☞ Go to page 96.
- ⑬ **Right key** For moving the cursor to the right or move a picture down ☞ Go to page 98.
- ⑭ **On/Off key** For turning the Stickerkid on or off ☞ Go to page 101.
- ⑮ **Left key** For moving the cursor to the left or moving a picture up ☞ Go to page 97.
- ⑯ **No key** For answering “no” when the Stickerkid asks you something ☞ Go to page 101.
- ⑰ **Yes key** For answering “yes” when the Stickerkid asks you something ☞ Go to page 101.
- ⑱ **Fast finger game key** .. For playing the Stickerkid’s typing game ☞ Go to pages 59 and 100.
- ⑲ **Multi-color printing keys** .. For printing a label with two or three ink colors ☞ Go to pages 52 and 97.
- ⑳ **Space/Feed key** For typing in an empty space or making more of the label come out ☞ Go to pages 17, 73 and 100.
- ㉑ **Code key** For doing the jobs written in green ☞ Go to page 100.
- ㉒ **Letter keys** For typing in letters ☞ Go to page 10.
- ㉓ **Print/Giant print key** ... For printing your label or making your letters bigger and putting them on two, three or four labels ☞ Go to pages 10, 48 and 98.
- ㉔ **Shift/CAPS key** For typing capital letters, the symbols that are on the top of the number keys and only capital letters ☞ Go to pages 10, 14 and 96.
- ㉕ **Symbol key** For choosing a symbol or typing in the pink marks that are on some of the keys ☞ Go to pages 21 and 95.
- ㉖ **Spanish accented letter key** . For typing in letters with Spanish accents ☞ Go to page 94.
- ㉗ **French accented letter key** .. For typing in letters with French accents ☞ Go to page 92.
- ㉘ **Number keys** For typing in numbers or the symbols that are on the top of the number keys



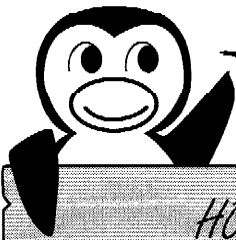

GET SET!

HOW TO PUT IN THE BATTERIES

First, you must put in the batteries before you can use the Stickerkid. If you don't understand something, ask an adult to help you.

1 Turn over the Stickerkid.

2 Pull the tab on the battery cover in the direction of the arrow to open it.

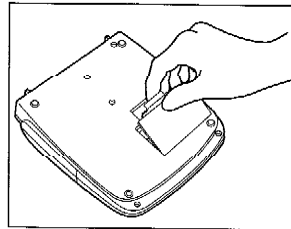

3 Look at the drawing on the back of the Stickerkid. It shows you how to put in the batteries.



• If you don't put the batteries in the right way, the Stickerkid will not work.

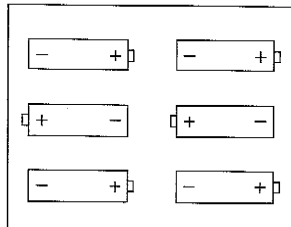

4 Put in six (6) new AA-size alkaline batteries.



• The batteries are not included.
• If there are empty batteries in the Stickerkid, take them all out before you put in new ones.

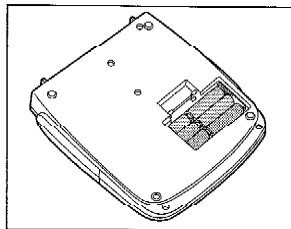

5 Close the battery cover.

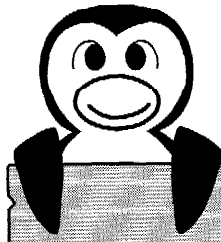

HOW TO PUT IN OR CHANGE THE TAPE CASSETTE

Before you can make a label, you must put in a tape cassette. If you don't understand something, ask an adult to help you.

- 1** Pull up on the two cassette cover tabs to open the cassette cover.

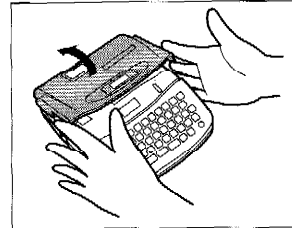

- 2** If the tape cassette is empty or if you want to use another one, use both hands to pull out the old cassette.

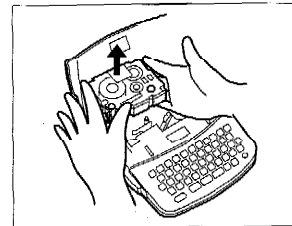

- 3** Put in the new cassette.



- Don't touch the print head. You may damage it.

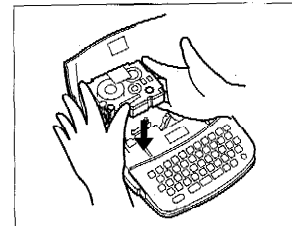

- 4** Close the cassette cover.

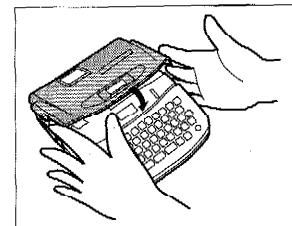

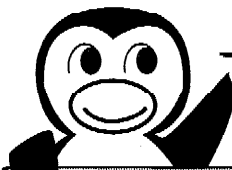





NOW, LET'S GO!

HOW TO TEACH THE STICKERKID YOUR NAME

If you teach the Stickerkid your name, the penguins will say "Hello!" to you when you turn the Stickerkid on and "GOOD BYE." to you when you turn it off.

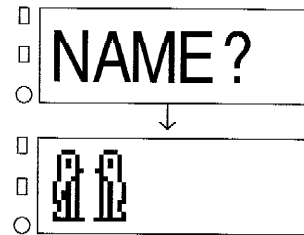

1 Check if the Stickerkid is turned off. If the Stickerkid is already on, push  to turn it off again.

2 Now, hold down , then push  +  at the same time. The Stickerkid plays a short tune and the message "NAME?" comes on for a short time. After that, two white penguins appear on the display.







3 Type in your name.



- To type in a capital letter, hold down  and push a letter key.
- If you make a mistake, push  to erase the letter. Then, finish typing in your name.
- If you try to type in more than 15 letters, the Stickerkid will beep. Why don't you try typing in your nickname instead?

Here is an example. If your name is Chris:

- Hold down  and push . Then, let go of  and .



- Push .

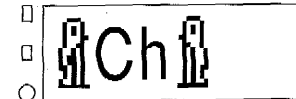

- Push .

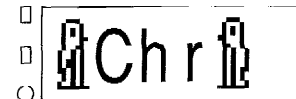



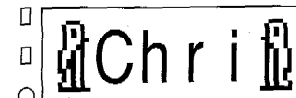

- Push .

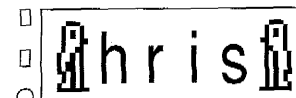



- Push .



 **4** Push . The message "Chris Hello!" comes on with the penguins and the Stickerkid plays a tune.

-  If you decide that you don't want your name to appear, push .
- If you don't push any keys for 5 minutes, the Stickerkid will go off.







The black penguin shows that you are at the beginning of the letters.

-  If you want to erase your name, go back and do steps 1 and 2. Push  to erase your name, then push .



Now, you can start making labels. If you keep reading, you will find out how easy it is to make all kinds of neat labels.

REVIEW

- To type in your name, hold down  and push  +  at the same time.
- To type in a capital letter, hold down  and push the letter key.
- To erase a letter, push .
- To answer "yes", push .
- To answer "no", push .

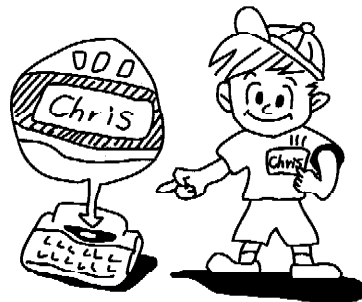











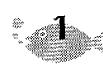

Let's make this label:



Let's practice making a name tag. After you have gone through the example, you can make a label with your own name on it. Labels like this can be put on letters, presents or place cards at parties. If you use your name, you can put the label on your things. So everyone will know they are yours.

TYPE IN THE LETTERS

 **1** Hold down  and push . Then, let go of  and . A note is played whenever you push a key. 

-  • To type in a capital letter, hold down  and push the letter key. Let go of  to type in small letters.
- If you make a mistake, push  to take out the letter. Then, finish typing.

 **2** Push . 

3 Push .



4 Push .



5 Push .

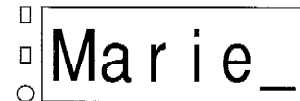



Now, let's print out this name tag. Read the next section to find out how.

PRINT THE LABEL

6 Push . The message "PRINTING" comes on and the Stickerkid starts printing the label.



- If you want to stop printing, push  to turn off the Stickerkid. Push  to it turn on again if you want to make more labels.

7 Wait until the Stickerkid stops printing the label.



- Don't use the cutter lever while you are printing a label.

8 Pull out the yellow cutter lever to cut off the printed label.



- The kinds of letters and the way the letters are printed on the label may be different depending on the style and font that you chose.  Go to pages 21 and 24.

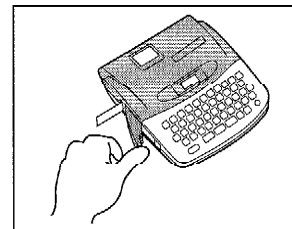

STICK ON THE LABEL

After you have made a label, you can put it on almost anything you want.

- 9** Leave the label as it is or cut it into any shape you want with scissors.

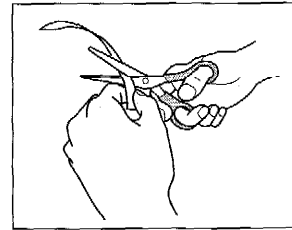

- 10** Turn the label over.

- 11** Bend the label along the line on the back. The two pieces of backing plastic should come off in the middle.



- If there is no line in the backing paper, use your fingernail to take off a corner of the paper. Then, peel off the backing paper.

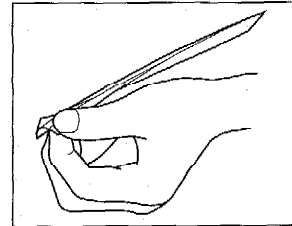

- 12** Peel off the two pieces of backing plastic.

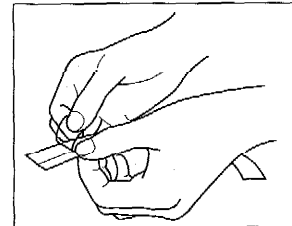

- 13** Stick your label on whatever you want.



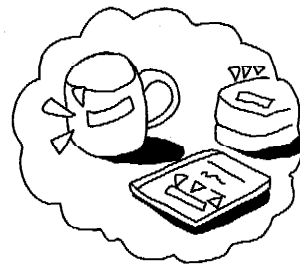

- Don't put labels on your body or in your mouth.
- Don't put labels where you are not supposed to.



Now, why don't you try making a name tag with your name on it? Keep reading to find out how to start a new label.

CLEAR THE DISPLAY

The Stickerkid remembers the font, style and letters you typed in – even when it’s turned off. This is good if you want to use them again. But if you want to make a new label, you have to get rid of the old one. Getting rid of an old label is called “clearing the display”.

- 14** Hold down  and push . The message “CLEAR?” comes on and a tune is played.



- 15** Push . The letters are erased and another tune is played. Then, the black penguin appears with the cursor.

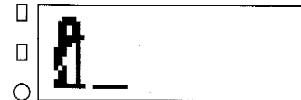







- If you decide that you don’t want to clear the display, push  instead.
- A note is usually played when you push a key and a tune is played when you make the Stickerkid do something.



- The black penguin shows that you are at the beginning of the letters.

You can now make a label with your name on it. If you forgot how to make a label, read the REVIEW below or go through the example again.

REVIEW

- To type in a capital letter, hold down  and push the letter key.
- To type in small letters, let go of  and push the letter keys.
- To take out a letter, push .
- To print out the label, push  or .
- To “clear” the display means to get rid of an old label.
- To clear the display, hold down  and push .



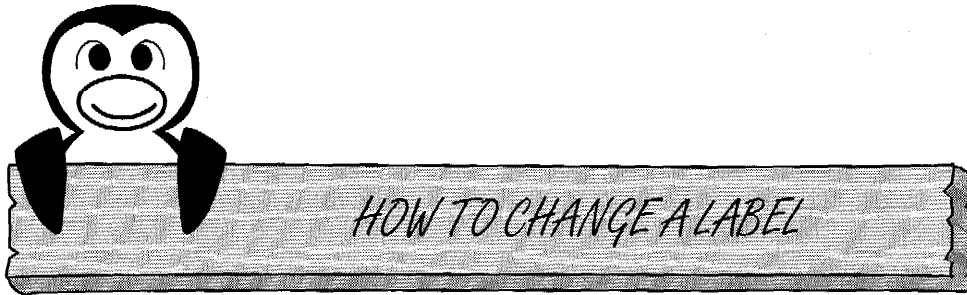

Let's make this label:



In this label, let's use all capital letters and fix a mistake in the label. You can put this label on anything that you don't want other people to open, like your diary or a folder with special secret papers in it.

TYPE IN ONLY CAPITAL LETTERS

1 Hold down and push . Then, let go of . The little circle beside CAPS comes on. This is the CAPS indicator.



2 Push .





3 Push .



4 Push .



 **5** Push  ^{2ND COLOR}. You are right. We should be typing "V". But we are making this mistake on purpose. We will learn how to correct it later.



 **6** Push .



 **7** Push .





 **8** Push .



Now, let's correct the label.

CHANGE THE LABEL

We made a mistake when we typed in "PRIBATE". The label should read "PRIVATE". So let's move the little flashing line (|) under the "A" to take out the "B". The little flashing line (|) is called a "cursor". The cursor should always be on the right of the letter that you want to erase. After we erase "B", let's put in "V" to correct the label. To put in a letter is called "inserting" a letter.

 **9** Push  three times to move the cursor under the "A".



 **10** Push  to erase the "B".



11 Push  to insert a "V".







Now, you can print out the label to see what it really looks like. Then, clear the display so you can make other labels.

12 Push  to print out the label.

13 Pull out the cutter lever to cut the tape.

14 Push  + , then push  to clear the display.

REVIEW

- To type in all capital letters, push  + . This will make the CAPS indicator come on.
- The little flashing line () is the "cursor".
- To move the cursor to the right, push .
- To move the cursor to the left, push .
- To erase a letter, push .
- To "insert" a letter means to put it in the label.
- To insert a letter, move the cursor to where you want to put it in. Then, push the key for the letter that you want to insert.



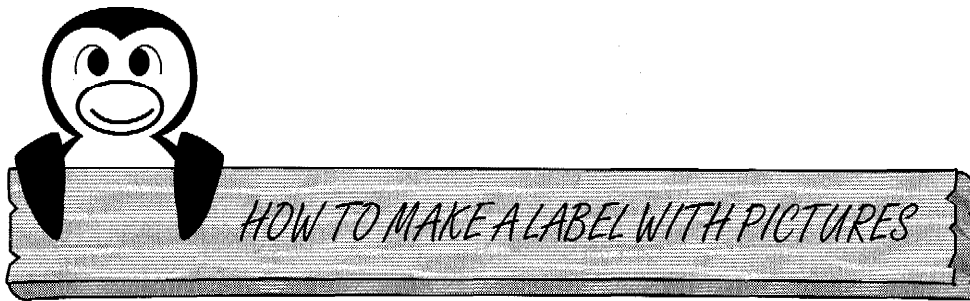



Let's make this label:



This time, let's try making a label with all capital letters and with pictures in it. It's a label for a drawer of your dresser. It will remind you which drawer has your shorts, swimming suits and other summer clothes in it.

CHOOSE THE FIRST PICTURE

 **1** Hold down  and push . The message "CHOOSE PICTURE" comes on for a short time. Then, three pictures from a group of pictures flash on the display. This means you can choose a picture from that group.



 **2** Push  or  until the plant group flashes. The picture we want to use is in this group.



3 Push YES . Pictures from that group appear on the display. One of them flashes. This means you can choose that picture.



4 Push DOWN or UP until the picture of the palm tree flashes. This is the one we want to use.



5 Push YES . The label comes on the display again. P appears on the display instead of the picture. But that is only on the display. The picture will look normal when it is printed on the label.



! • Anytime you want to see what a picture looks like, put the cursor under P and push YES . Push DOWN to move down and push UP to move up, so you can see the rest of the picture. When you are finished looking at the picture, push NO or YES again to go back to the label.



Now, let's make the rest of the label.

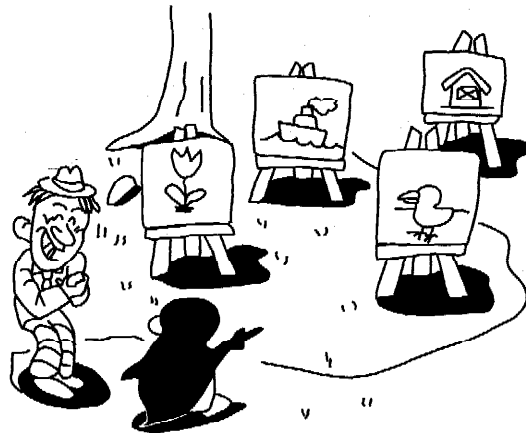

TYPE IN THE LETTERS

6 Type in "SUMMER" in all capital letters.

□
□
● UMMER_

7 Push  to put in a space.



□
□
● MMR _

8 Type in "CLOTHES" in all capital letters.

□
□
● OTHES_

☞ If you don't remember how to type in letters, go back to page 14.

CHOOSE THE SECOND PICTURE

9 Hold down  and push . The message "CHOOSE PICTURE" comes on for a short time. Then, three pictures from the last group we used flash on the display.

□
□
○ CHOOSE PICTURE
↓
□
□
● 

10 Push  one time. The picture we want to use is in this sports group.



- When a picture group flashes, you can choose a picture from that group.

□
□
● 

11 Push . Pictures from that group appear on the display. One of them flashes.



- This means you can choose that picture.

□
□
● 

- 12 Push or until the picture of the swimming dog flashes. This is the one we want to use.



- 13 Push . The label comes on the display again. appears on the display instead of the picture. But that is only on the display. The picture will look normal when it is printed on the label.



Now, you can print out the label to see what it really looks like. Then, clear the display so you can make other labels.

- 14 Push to print out the label.

- 15 Pull out the cutter lever to cut the tape.

- 16 Push + , then push to clear the display.

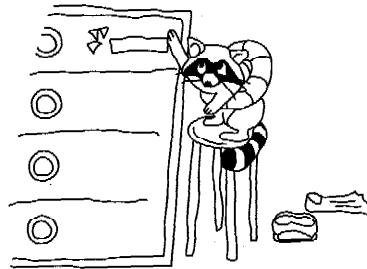

REVIEW

- To choose a picture, push + . Push or until you find the group you want, then push . Push or until you find the picture you want. Then, push to choose it. appears on the display.
- To see what a picture looks like, put the cursor under and push . Then, push to move down and to move up. Push or to go back to the label.
- To type in an empty space, push .

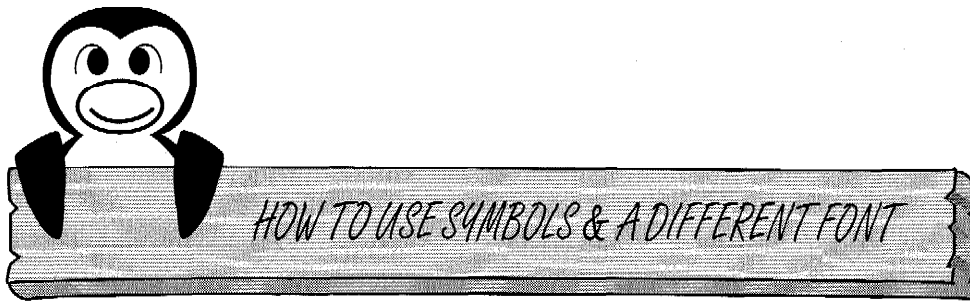

Let's make this label:



Now, we can try making a label with symbols and a different kind of letters. The different kinds of letters are called "fonts".

CHOOSE A SYMBOL

1 Hold down CODE and push SYMBOL. The message "CHOOSE SYMBOL" comes on for a short time. Then, the symbols appear on the display. The cursor is under the symbol that you can choose.

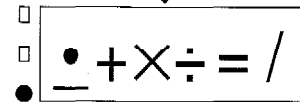
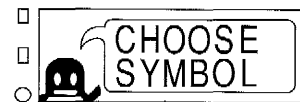

2 Push or until the cursor is under ★.



3 Push YES. The black penguin appears with the symbol that you chose.



TYPE IN THE LETTERS

4 Type in "LEE".



If you don't remember how to type in letters, go back to page 14.

CHOOSE THE SAME SYMBOL AGAIN

5 Hold down **CODE** and push **SYMBOL**. The message "CHOOSE SYMBOL" comes on for a short time. Then, the cursor appears under the last symbol that we chose. This is the one that we want.

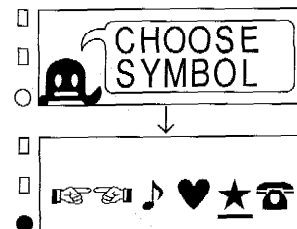

6 Push **YES**. The label appears with the symbol in it.



Now, let's learn how to change the font.

CHANGE THE FONT

7 Hold down **CODE** and push **A-A**. The message "CHOOSE FONT" comes on for a short time. Then, an example of the font that we are now using appears on the display.

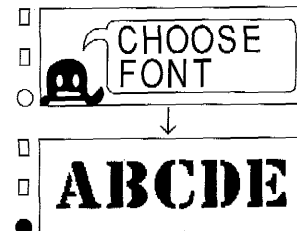

8 Push **←** or **→** until **ABC** appears on the display. This is the font we want to use.



9 Push YES . The label appears on the display again.



• The font doesn't change when you clear the display. You have to change it when you make your next label if you want to use another font.



Now, you can print out the label to see what it really looks like. Then, clear the display so you can make other labels.

10 Push GIANT PRINT to print out the label.

11 Pull out the cutter lever to cut the tape.

12 Push CODE + , then push YES to clear the display.

REVIEW

- To show the symbols, push LARGE + SYMBOLS . Push LEFT or RIGHT until you find the one you want. Then, push YES to choose it.
- “Fonts” are the different kinds of letters.
- To show the fonts, push CODE + A:A . Push LEFT or RIGHT until you find the font you want. Then, push YES to choose it.

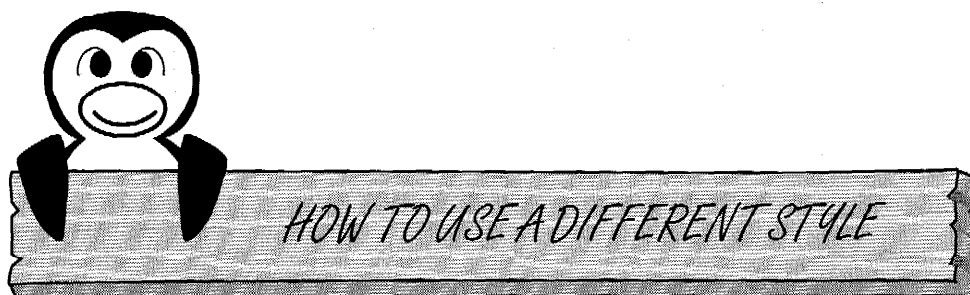

Let's make this label:

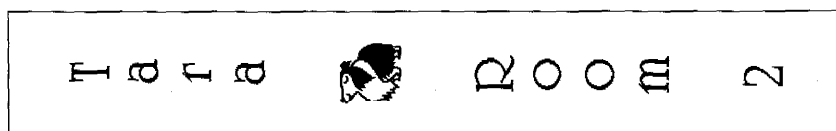

Now, let's try making a label for a school notebook. We want to use small letters, a picture and a different way of printing the letters. The different ways of printing letters are called "styles".

TURN OFF CAPS

Since we are also going to type in small letters, we can turn off the CAPS indicator.

1 Hold down CODE and push SHIFT CAPS. The CAPS indicator goes off.

TYPE IN THE LETTERS

2 Hold down SHIFT CAPS and push T.

3 Type in "ara".

 **4** Push  to put in a space.

Tara _
 Tara _

 **5** Type in "Room".

Room_
 Room_

 **6** Push  .

Room _
 Room _

 **7** Type in "2".



oom 2_
 oom 2_

 If you don't remember how to type in letters, go back to page 14.



CHANGE THE FONT

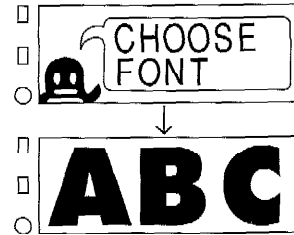

- The font does not change after you print a label or clear the display. If you want to use a different font in your next label, you will have to change it again.

8 Hold down  and push . The message "CHOOSE FONT" comes on for a short time. Then, an example of the font that we are now using appears on the display.



9 Push  or  until ABCDEF appears on the display. This is the font we want to use.





10 Push . The label appears on the display again.





Now, let's learn how to change the style of the letters.

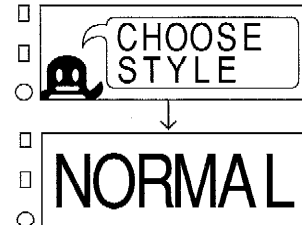

CHANGE THE STYLE

- 11** Hold down  and push . The message “CHOOSE STYLE” comes on for a short time. Then, the name of the style that we are now using appears on the display.

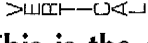

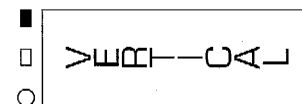
- 12** Push  or  until  appears on the display. This is the style we want to use.



- 13** Push . The label appears on the display again and the little square beside  comes on. This is the style indicator.



- The style doesn't change when you clear the display. You have to change it next time you make a label if you want to use another style.

MOVE THE CURSOR

We want to put a picture in the middle of the label. So we have to move the cursor to the middle of the label.

- 14** Push  six times.

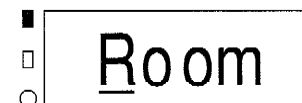

CHOOSE A PICTURE

15 Hold down and push . The message "CHOOSE PICTURE" comes on for a short time. Then, three pictures from the last group we used flash on the display.

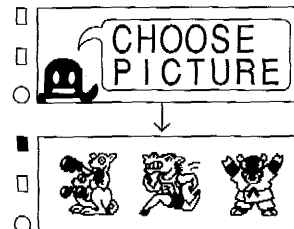

16 Push or until the animal group flashes. The picture we want to use is in this group.



17 Push . Pictures from that group appear on the display. One of them flashes.



• This means you can choose that picture.



18 Push or until the picture of the collie flashes. This is the one we want to use.



19 Push . The label comes on the display again. appears on the display instead of the picture. But that is only on the display. The picture will look normal when it is printed on the label.



20 Push .



☞ If you don't remember how to choose a picture, go back to page 17.

Now, you can print out the label to see what it really looks like. Then, clear the display so you can make other labels.

21 Push  to print out the label.

22 Pull out the cutter lever to cut the tape.







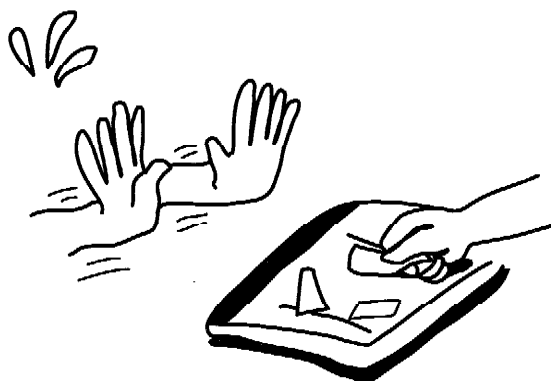

23 Push  + , then push  to clear the display.



• Don't put labels on books that are not yours.



REVIEW

- To type in small letters after typing in all capital letters, push  + . This will make the CAPS indicator go off.
- “Styles” are the different ways letters are printed.
- To show the styles, push  + . Push  or  until you find the style you want. Then, push  to choose it. This will make the styles indicator beside  come on.

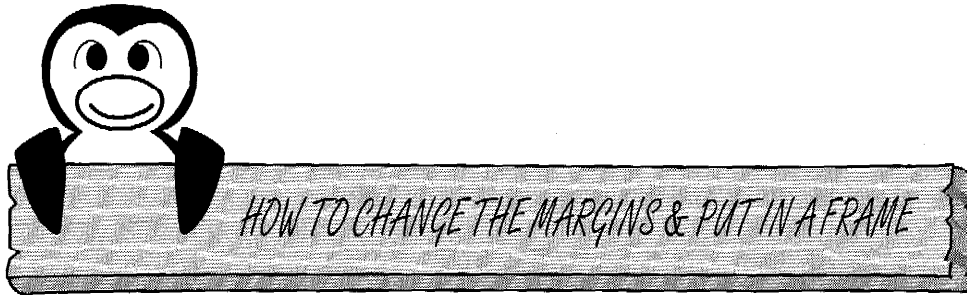

Let's make this label:





You can change the size of the spaces on the left and right sides of a label. These empty spaces are called "margins". Let's also put a frame around this label to make it look nicer. The "frame" is the pictures and lines around the letters.

CHANGE THE STYLE





- The style does not change after you print a label or clear the display. If you want to use a different style in your next label, you will have to change it again.

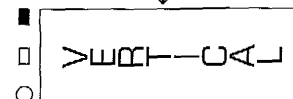

1 Hold down  and push . The message "CHOOSE STYLE" comes on for a short time. Then, the name of the style that you are now using appears on the display.



2 Push  or  until *ITALIC* appears on the display. This is the style we want to use.



 **3** Push YES . The penguin appears on the display again and the style indicator beside **B**~**B** stays on.





Now, let's learn how to change the margins.

CHANGE THE MARGINS

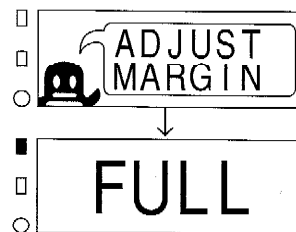
 **4** Hold down CODE and push MARGIN . The message "ADJUST MARGIN" comes on for a short time. Then, the margin size appears on the display.





 • If the Stickerkid is turned off and then turned back on again, the margin size will change back to FULL. If you want a different margin size, you will have to change it again.

 **5** Push S or L until SMALL appears on the display. This is the margin size we want to use.

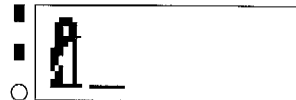

 **6** Push YES . The black penguin appears on the display and the little square beside MARGIN comes on. This is the margin indicator.



 • If you print many labels with no margins, you can make one label with different fonts and styles.  Go to page 70.



TYPE IN THE LETTERS

 **7** Type in "Hi Kerry".
 Push   to type in a space.

  Kerry_



 If you don't remember how to type in letters, go back to page 10.

 **8** Hold down  and push  to type in the exclamation mark (!).

  erry!_

MOVE THE CURSOR

We want to put a frame around the label. The cursor must be under one of the letters that you want to frame. So we have to move the cursor back under one of the letters in the label.

 **9** Push  one time. You can push  more often, but you don't have to. As long as the cursor is under one of the letters that you want to frame, it is okay.

  erry!

We can, now, put a frame around the letters.



CHOOSE A FRAME

You can choose from twenty different frames. And you can choose the frame before or after you type in the letters.

- 10** Hold down CODE and push ^(A). The message "CHOOSE FRAME" comes on for a short time. Then, a frame appears on the display.

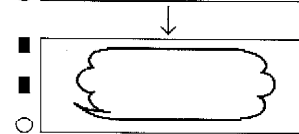

- 11** Push or until  appears on the display. This is the frame we want to use.

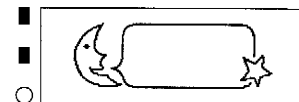

- 12** Push YES. The message "FRAMED" comes on for a short time. Then, the label appears with part of the frame around it. The frame will go around the whole label when it is printed.

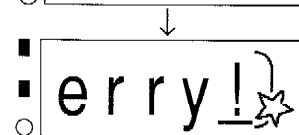

Now, you can print out the label to see what it really looks like. Then, clear the display.

- 13** Push PRINT GIANT PRINT to print out the label.

- 14** Pull out the cutter lever to cut the tape.





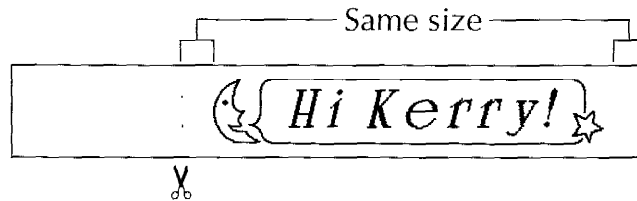

Because we made the margins smaller, the empty spaces on the sides of the label are not the same size anymore. But two dots are printed on the label. If you cut the label on these two dots, the margins will be the same size.

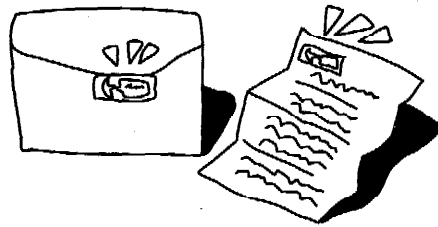

- 15 Push + , then push to clear the display.



REVIEW

- “Margins” are the empty spaces on the sides of the label.
- To change the size of the margins, push + . Push  or  until you find the margin you want, then push . This will make the margin indicator beside come on.
- To type in an empty space, push .
- “Frames” are pictures and lines around the letters.
- To put a frame around the letters, push + . Push  or  until you find the frame you want. Then, push to choose it.

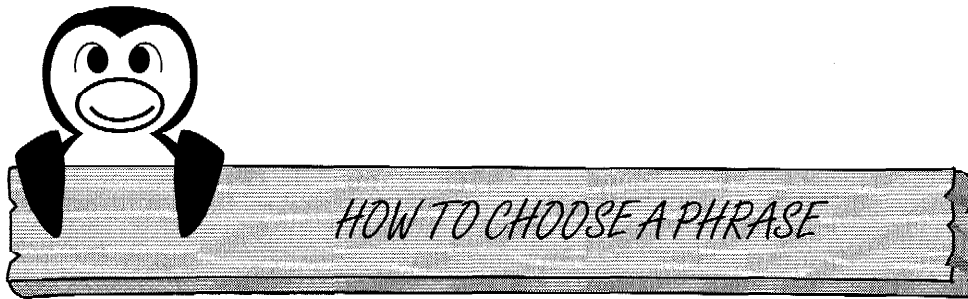

Let's make this label:



The Stickerkid's Language Master knows eight phrases in seven languages. The phrases are: "Good morning!", "Good bye.", "Thank you!", "I love you!", "Congratulations!", "How are you?", "Merry Christmas!" and "Happy Birthday!". Each phrase can be printed in seven languages. The languages are: French (FRA), German (GER), Spanish (ESP), Italian (ITA), Chinese (CHN), Korean (KOR) and English (USA).





- *On these labels, the letter style will always be NORMAL and the margins will always be FULL.*

Let's try making a label in another language.



CHOOSE THE PHRASE

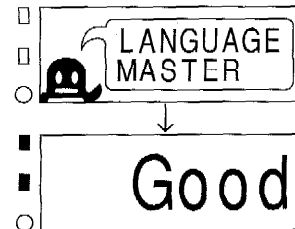

 **1** Hold down  and push . The message "LANGUAGE MASTER" comes on for a short time. Then, the first phrase moves across the display.



 **2** Push  or  until the phrase "Thank you!" moves across the display.







CHOOSE THE LANGUAGE

 **3** Push . The first language comes on the display with a picture of that country's flag.



• If you look at the country's name and flag, you can tell which language is chosen.



 **4** Push  or  until "GER" and  appears on the display.  is the German flag and "GER" stands for Germany. The language is German. This is the language we want to use.



PRINT THE LABEL

- 5 Push YES. The message "PRINTING" comes on and the Stickerkid prints the label.



- "Danke" means "Thank You" in German.

- 6 Pull out the cutter lever to cut the tape.



REVIEW

- To print a phrase in another language, push CODE + 8. Push or until you find the phrase you want, then push YES. Push or until you find the language you want. Then, push YES to print it out.

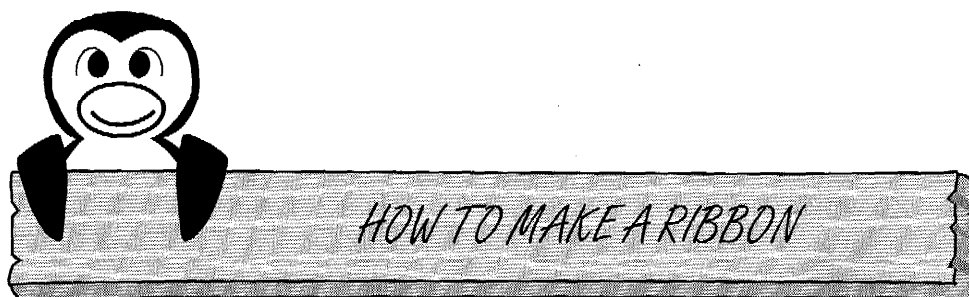

Let's make this label:

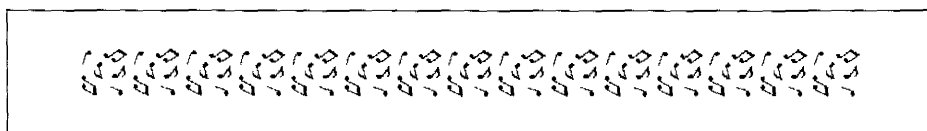

Now, let's try making a label with a pattern on it. You can use these labels to decorate cards, presents or almost anything else. There are eleven different patterns. One of them chooses a head and different faces and puts them together to make a ribbon. Your ribbon will be different each time you choose the mystery pattern.



• *The ribbon labels will always have FULL margins.*

CHOOSE THE PATTERN

 **1** Hold down and push . The message "MAKE RIBBON" comes on for a short time. Then, the patterns appear on the display. One of them flashes. This means you can choose that pattern.

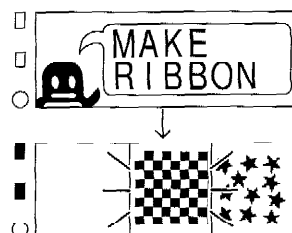

2 Push or until the musical note pattern flashes. This is the pattern we want to use.

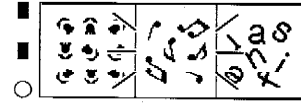

3 Push .

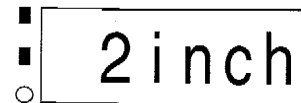

Now, you can choose how long you want the ribbon to be.

CHOOSE THE RIBBON LENGTH

4 Push until "4inch" appears on the display.

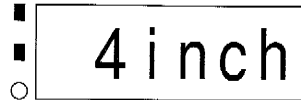

You can also see how long the ribbon will be in centimeters. Push to see the length in centimeters. Push again to change the length back to inches.

PRINT THE LABEL

5 Push . The message "PRINTING" comes on and the Stickerkid prints the label.



6 Pull out the cutter lever to cut the tape.

REVIEW

- To print a ribbon, push + . Push or until you find the pattern you want, then push . Push or until you find the length you want. Then, push to print it out.



Let's make this label:







Now, let's make our own picture and put it in a label.

TYPE IN THE LETTERS





1 Type in "I LOVE ICE CREAM!"



- To type in all capital letters, hold down  and push . The CAPS indicator comes on.
- Push  to type in a space.
- To type in an exclamation mark (!), hold down  and push . If you don't remember how to type in letters, go back to page 14.
- If the Stickerkid is turned off and then turned back on again, the margin size will change back to FULL. If you want a different margin size, you will have to change it again. If you don't remember how to change the margins, go back to page 30.



MOVE THE CURSOR



 **2** Push  one time.







- The cursor must be under one of the letters you want to put in the frame.



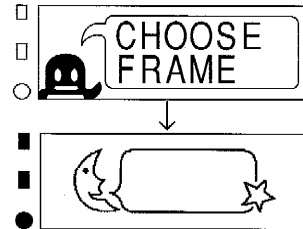

CHOOSE A FRAME

 **3** Hold down  and push . The message “CHOOSE FRAME” comes on for a short time. Then, the frame we used last time appears on the display.

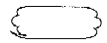

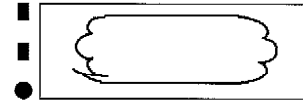
 **4** Push  or  until  appears on the display. This is the frame we want to use.



 **5** Push . The message “FRAMED” comes on for a short time. Then, the label appears with part of the frame around it.

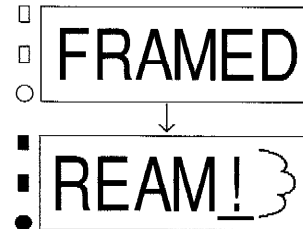

 If you don't remember how to choose a frame, go back to page 30.



MOVE THE CURSOR AGAIN

 **6** Hold down  until the cursor is under the beginning of the frame.



MAKE A PICTURE

Pictures can be made by putting together a head and a face or a head and a body. The Stickerkid has lots of different heads, faces and bodies. There are even children's and animals' heads, too.

7 Hold down  and push . The message "MAKE PICTURE" comes on for a short time. Then, the types of pictures that you can make appear on the display. One of them flashes. This means you can make pictures like that.

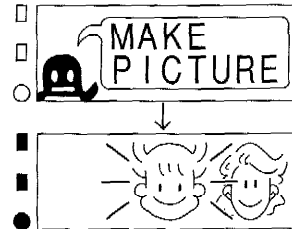

8 Push  or  until  flashes. This is the kind of picture we want to make.

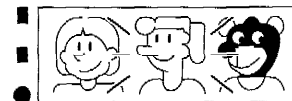

9 Push . A head and body appear on the display. The head flashes. This means you can choose this head.

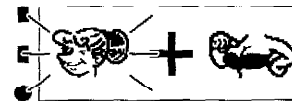

10 Push  or  until  flashes. This is the head we want to use.

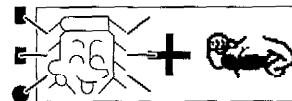

11 Push . The body flashes. This means you can choose that body.

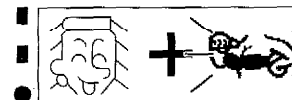

12 Push  or  until  flashes. This is the body we want to use.

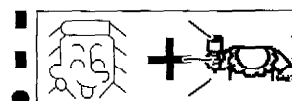



13 Push . The message "CHECK?" comes on the display.





14 Push  to see part of the picture.



15 Push  to move down and push  to move up, so you can see the rest of the picture.

16 Push YES. **P** appears on the display instead of the picture. But that is only on the display. The picture will look normal when it is printed on the label.



• Anytime you want to see what a picture looks like again, put the cursor under **P** and push YES. Push  to move down and push  to move up, so you can see the rest of the picture. When you are finished looking at the picture, push NO or YES again to go back to the label.









Now, you can print out the label to see what it really looks like. Then, clear the display, so you can make other labels.

17 Push  to print out the label.

18 Pull out the cutter lever to cut the tape.

19 Push CODE + , then push YES to clear the display.

REVIEW

- To make a picture, push CODE + . Push  or  until you find the kind of picture you want to make, then push YES. Push  or  until you find the head you want. Then, push YES to choose it. Push  or  until you find the face or body you want, then push YES to choose it. **P** appears on the display.
- To check the picture, put the cursor under **P** and push YES. Then, push  to move down and  to move up. Push NO or YES to go back to the label.



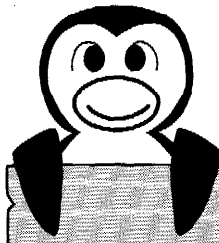

HOW TO MAKE A SECRET MESSAGE

Let's make these labels:

Let's meet today after school.

dDH'pSSIPDd4XXbVpBn8W1UHPmF6b.

This function is awesome! With your Stickerkid, you can write and read secret messages that nobody else can read! Only a Stickerkid can crack the code. Now, let's try making a secret message. Let's also change the font to make the message smaller.

TURN OFF CAPS

We are going to type in small letters. So we can turn off the CAPS indicator.

1 Hold down **CODE** and push **SHIFT CAPS**. The CAPS indicator goes off.



TYPE IN THE MESSAGE

2 Type in "Let's meet today after school."

! To type in the apostrophe ('), hold down **SYMBOL** and push **SHIFT COLOR**.

💡 To type in a capital letter, hold down **SHIFT CAPS** and push a letter key.





👉 If you don't remember how to type in letters, go back to page 10.



ENCODE THE SECRET MESSAGE

The Stickerkid can encode your message. To “encode” a message means to change your message into a secret message with a secret code. So only you and your friends will be able to read it.

-  **3** Hold down and push . The message “SECRET CODE” comes on for a short time. Then, the message “ENCODE” comes on the display.

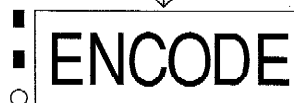

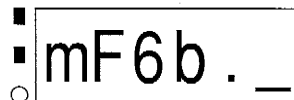

-  **4** Push . The letters of “ENCODE” start flashing. Then, the encoded message appears on the display.





Look at the message. It is so hard to understand. I bet nobody else can read that.

Now, let’s make the font smaller, so the label will be shorter.

CHANGE THE FONT

-  **5** Hold down and push . The message “CHOOSE FONT” comes on for a short time. Then, an example of the font that we are now using appears on the display.



-  **6** Push  or  until ABCDEFG appears on the display. This is the font we want to use.

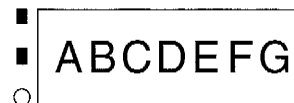

- 7 Push . The label appears on the display again.

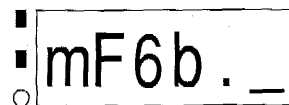

Now, you can print out the message to see what it looks like. Then, clear the display, so you can make other labels.

- 8 Push to print out the label.
- 9 Pull out the cutter lever to cut the tape.
- 10 Push + , then push to clear the display.

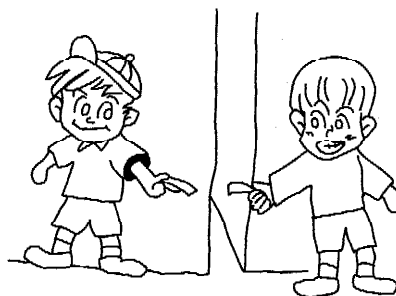

DECODE THE SECRET MESSAGE

If you get a secret message from one of your friends, the Stickerkid can change it into a message you can read. This is called “decoding” the message.

First, you have to type in the secret message.

- 11 Type in “dDH’pSSiPDd4XXbVpBn8W1UHPmF6b.”

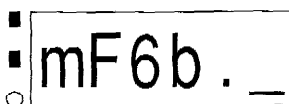

Now, you can decode it, so you can find out what it says.

- 12 Hold down and push . The message “SECRET CODE” comes on for a short time. Then, the message “ENCODE” comes on the display. But we don’t want to encode a message. We want to decode one.

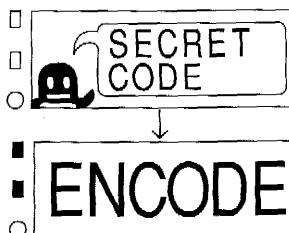

13 Push  or  one time. The message “ENCODE” changes to “DECODE”.

■ DECODE
○

14 Push . The letters of “DECODE” start flashing. Then, the decoded message appears on the display. Isn’t that cool?

■ hool._
○









Now, you can print out the message to see what it looks like. Then, clear the display, so you can make other labels.

15 Push  to print out the label.

16 Pull out the cutter lever to cut the tape.

17 Push  + , then push  to clear the display.

REVIEW

- To “encode” a message means to use a secret code to make a message into one that everyone can’t read.
- To encode a message, push  +  and push .
- To “decode” a message means to use a secret code to change a secret message into one that you can read.
- To decode a message, push  +  and push  or  one time until “DECODE” appears on the display. Then, push .



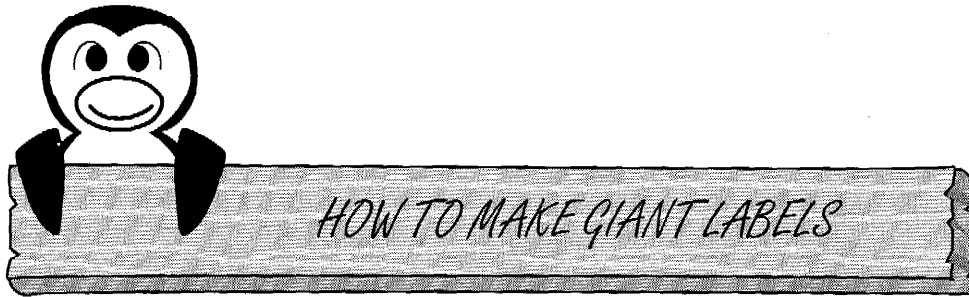

Let's make this label:



This time, let's make a label that is three times the size of a normal label. You can put giant labels on your dog's house, your cat's litterbox or your fish's bowl. You can also make a giant label with your name on it, stick it to a piece of cardboard or wood and hang the sign on your bedroom door. If you put a picture in the label, it will also be blown up bigger when it is printed out.



• *The giant labels will always have 1/2" (12 mm) margins.*

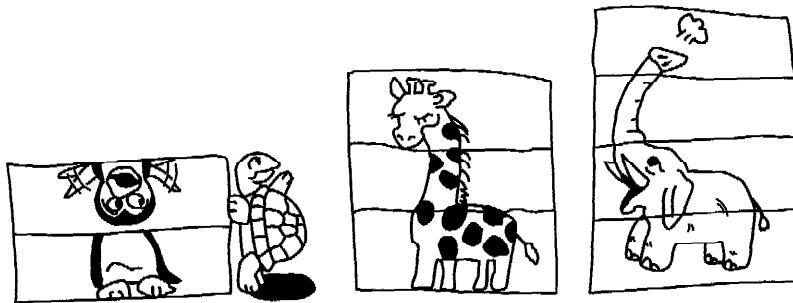



TYPE IN THE LETTERS



1 Type in "SPOT".



- To type in all capital letters, hold down  and push . The CAPS indicator comes on.



☞ If you don't remember how to type in letters, go back to page 14.

CHANGE THE FONT



2 Change the font to **ABC**.



☞ If you don't remember how to change the font, go back to page 21.

CHANGE THE STYLE



3 Change the style to **NORMAL**.





☞ If you don't remember how to change the style, go back to page 24.

PRINT THE GIANT LABEL

You can make giant labels that are two to four times the size of a normal label. In this label, the word "SPOT" will be three times the normal size and printed on three different labels.



4 Hold down  and push . The message "GIANT PRINT" comes on for a short time. Then, you can choose how big you want the label to be.

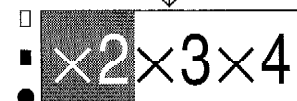

5 Push  one time. We want to make it three times the normal size.



6 Push . The message "PRINTING" appears and the Stickerkid prints the labels.



7 Pull out the cutter lever to cut the tape.

Three labels connected together are printed out. Put them together to make a giant label.

PUT TOGETHER THE LABEL

8 Cut out the three labels.



- Two dots are printed on the label to show you where the ends of the labels are. If you cut on these two dots, you will get three labels that are the same size.

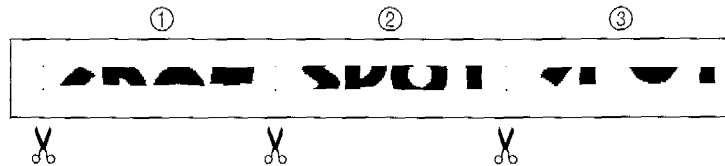

9 Cut off the empty space on the bottom of the first label. This is the top of the giant label.

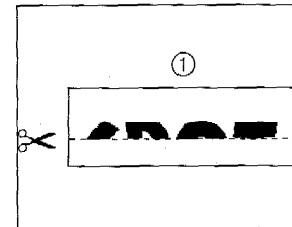

10 Cut off the empty spaces on the top and bottom of the second label. This is the middle of the giant label.

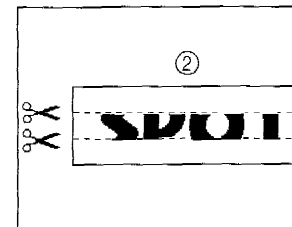

11 Cut off the empty space on the top of the third label. This is the bottom of the giant label.

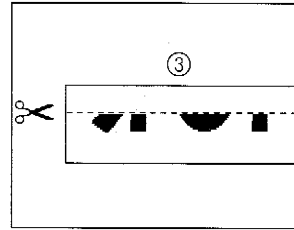

12 Put the three labels together to make a giant label.

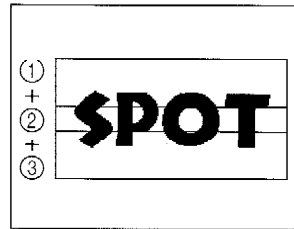

Now, you can stick this giant label on anything you want.

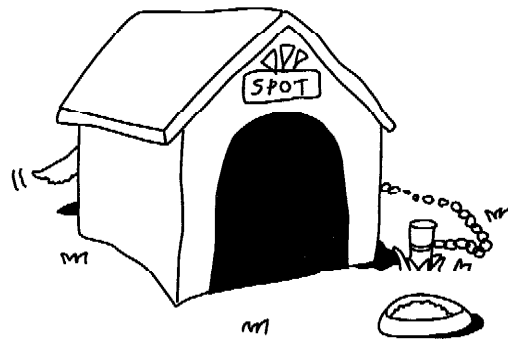

Now, you can clear the display.

13 Push + , then push to clear the display.

REVIEW

- To print a giant label, push + . Push or until you find the size you want, then push . Cut out the labels and put them together.

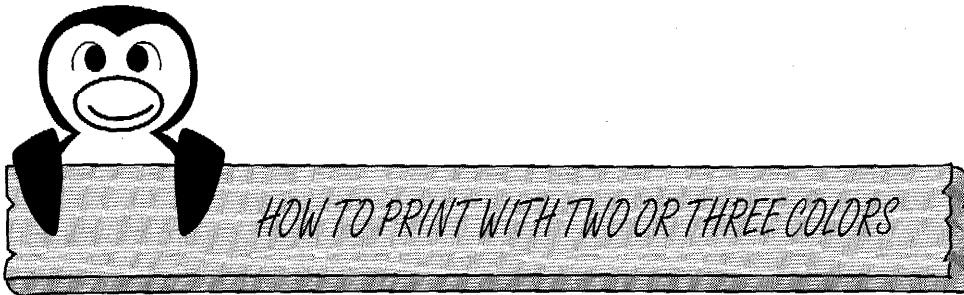

Let's make this label:



You can also make a label with two or three different ink colors. This lets you make more colorful, original labels. You will need the special Multi-color printing ink and tape cassettes if you want to make a label with different colors.



- The multi-color printing ink and tape cassettes will be available starting in February 1996.

TURN OFF CAPS

- 1 Hold down  and push . The CAPS indicator goes off.



TYPE IN THE LETTERS

- 2 Type in "Happy Birthday!"

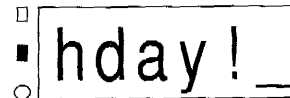

MOVE THE CURSOR

- 3 Push  one time.



- The cursor must be under one of the letters you want to put in the frame.

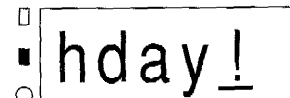

CHOOSE A FRAME

4 Hold down and push . The message "CHOOSE FRAME" comes on for a short time. Then, a frame appears on the display. But we want another frame.

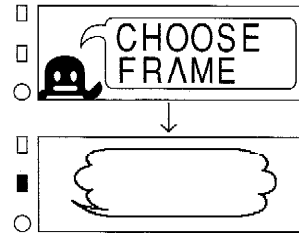

5 Push or until appears on the display.

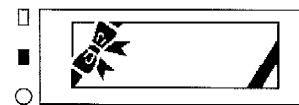

6 Push . The message "FRAMED" comes on for a short time. Then, the label appears with the frame around it.

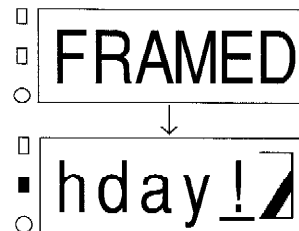

CHOOSE THE COLORS

7 Hold down and push . The message "CHOOSE COLOR" comes on for a short time. Then, everything flashes with .



- You can decide which colors will be first, second and third.
- If you change the colors in one word many times, the letters may be printed on top of each other.

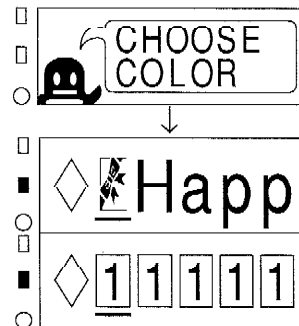

8 Hold down and push . The beginning of the frame will flash with and the cursor moves under the "H".



- The whole frame will be printed in the same color. If you make the end of the frame flash with 1, it won't matter. The whole frame will be the color of the number at the beginning.
- If you change your mind, move the cursor to the number you want to change and change it.
- To change a color back to the first color, hold down and push .

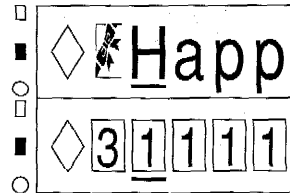

9 Push until the cursor is under the "B".

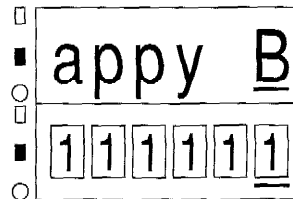

10 Hold down and push . The "B" will flash with and the cursor moves under the "i".

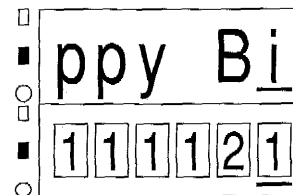

11 Hold down and keep pushing until all of "Birthday" flashes with .

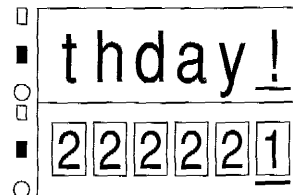

PRINT THE LABEL

- 12 Push or . The message "INSERT 1COLOR" appears on the display.

INSERT
 1
 COLOR

- 13 Open the cassette cover. If you have to change the tape and ink cassette, take out the cassettes that are already in there.

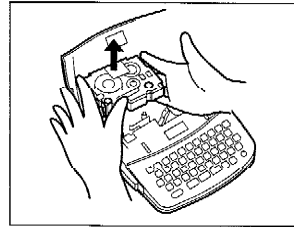

- 14 Turn the ribbon roll in the ink cassette and make the ribbon tight. Then, hold the tabs on the first color's ink cassette and put it straight into the tape cassette that you want to use. Pull out about 1/2" of tape.

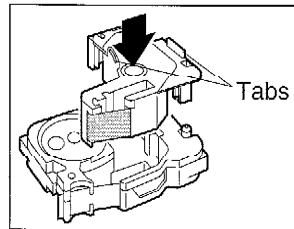

- If the tape cassette is new, take the clear tape off the end of the label tape.

- 15 Put in the cassettes and close the cassette cover. Then, hold down and push and and pull out the cutter lever to cut the tape.

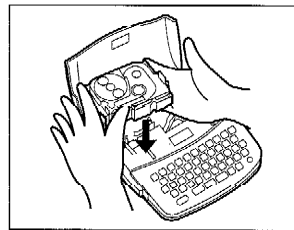

- 16 Push . The message "PRINTING" comes on and the Stickerkid prints the letters with the first color. Then, the message "REWIND" appears on the display.

PRINTING
 ↓
 REWIND

- 17 Open the cassette cover and slowly turn the tape roll with your finger to rewind the tape. Make the end of the tape go just inside the exit slot.

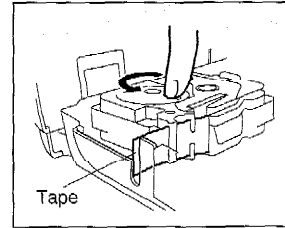

- 18 Push YES . The message "INSERT 2COLOR" appears on the display.



- 19 Hold the tabs and take out the first color's ink cassette.

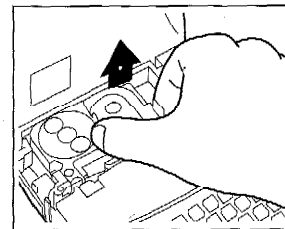

- 20 Put in the ink cassette for the second color and close the cassette cover.

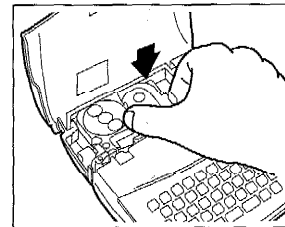

- 21 Push YES . The message "PRINTING" comes on and the Stickerkid prints the letters with the second color. Then, the message "REWIND" appears on the display.

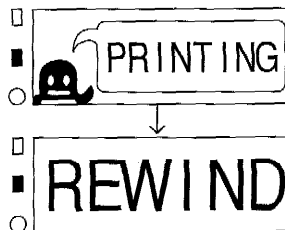

- 22 Open the cassette cover and slowly turn the tape roll with your finger to rewind the tape. Make the end of the tape go just inside the exit slot.

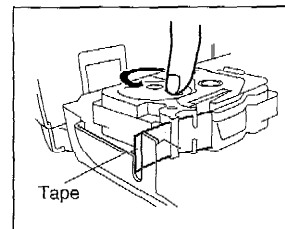

23 Push YES . The message "INSERT 3COLOR" appears on the display.



24 Hold the tabs and take out the second color's ink cassette.

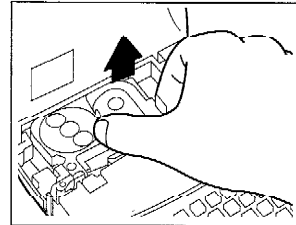

25 Put in the ink cassette for the last color and close the cassette cover.

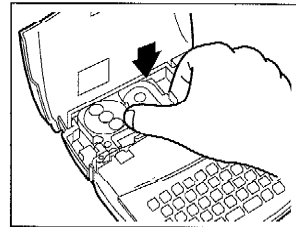

26 Push YES . The message "PRINTING" comes on and the Stickerkid finishes printing the label.



27 Pull out the cutter lever to cut the tape.

28 Push CODE + , then push YES to clear the display.

If you wind the tape too much and the end goes back into the cassette.

1. Take out the ink and tape cassettes and take ink cassette out tape cassette.

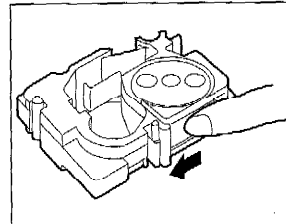

2. Use your finger to move the tape and make it go into the cassette.



If there is only a little tape left in the cassette, pull out some tape and put it into the slot with your fingers.

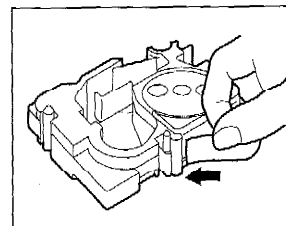

3. Use your finger to make the end of the tape go through the slot.

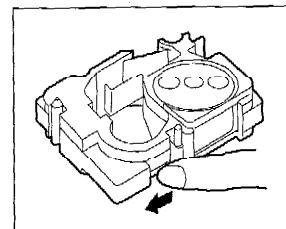

4. Use your finger to move the tape and make it go under the tape guides.



Make sure the tape goes under the tape guide on the edge of the cassette.

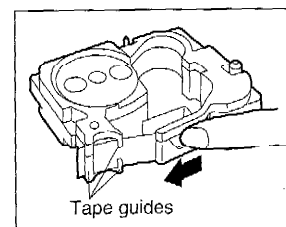

5. Hold the end of the tape and rewind the tape to tighten it.



When you rewind the tape, turn the tape roll counterclockwise (↺).

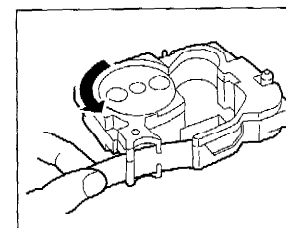

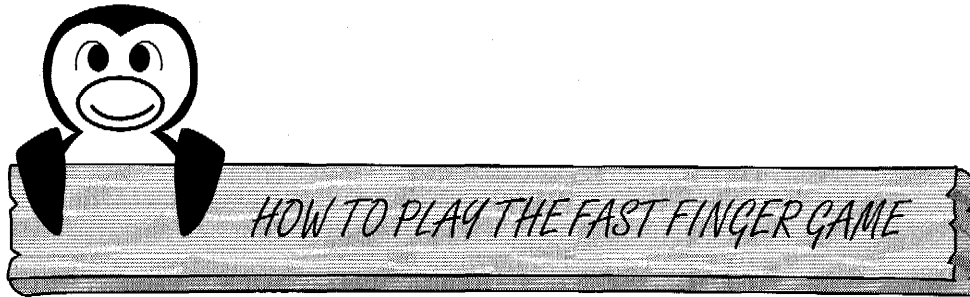

Try this typing game to find out how fast you are or use it to practice typing.

TYPE IN YOUR NAME



- 1 Push . The message "FAST FINGER" appears for a short time. Then, the message "NAME?" comes on for a short time. After that message goes off, two white penguins appear on the display.



- 2 Type in your name.

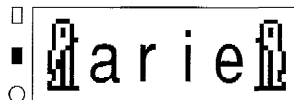

If your name is Marie, the display will look like this after you type it in:

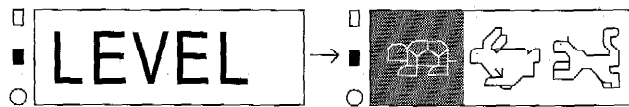

- 3 Push . The message "LEVEL" comes on for a short time. Then, pictures of a turtle, a rabbit and a cheetah appear on the display. The turtle is the slowest level, the rabbit is the middle level and the cheetah is the fastest level. We have to use  or  to choose the level we want.



CHOOSE THE LEVEL

- 4 Push  or  until the rabbit is chosen. This is the level we want to try.



- 5 Push . First, the turtle and cheetah will disappear and a tune will play. Then, the Stickerkid will count down and the message "START!" will appear. The first letter will appear with the rabbit.

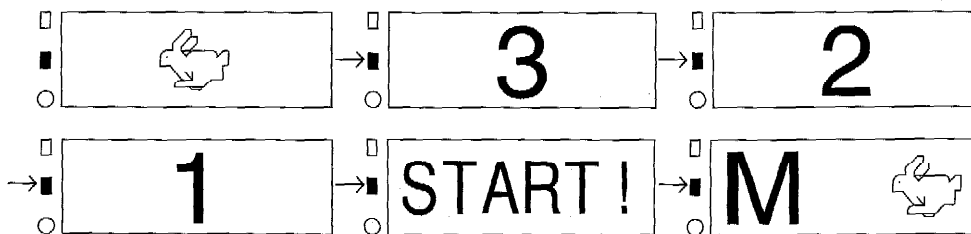

PLAY THE GAME

 **6** Push .

If you push the right key at the right time, the rabbit will turn into a party cracker. Then, the next letter will appear on the display.

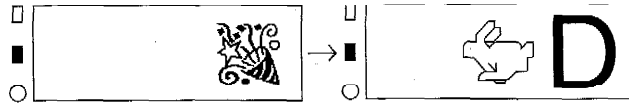

If you push the wrong key, the rabbit will turn into a bomb. Then, the next letter will appear on the display.



 **7** Push the key for each letter that comes on the display. After you push the key for the last letter, the message "OVER!" appears for a short time. Then, the message "PRINT?" comes on the display.

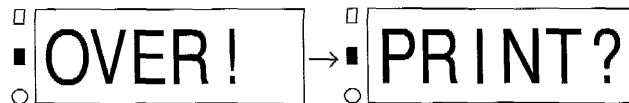

- 8 Push YES. The message "PRINTING" appears and the Stickerkid prints out your score and a message. Then, the message "DONE?" comes on the display.

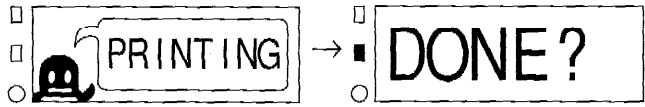

-  • If you decide that you don't want to print a label, push NO. Your message will move across the display.

PLAY THE GAME AGAIN

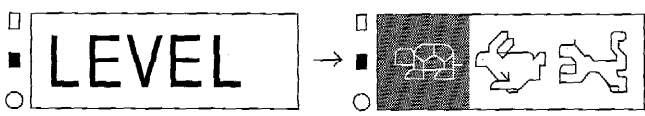

- 9 Push NO to play again. The message "LEVEL" comes on for a short time. Then, pictures of a turtle, a rabbit and a cheetah appear on the display again.



-  • If you decide that you don't want to play again, push YES.

- 10 Go back to step 4. Continue until you get perfect scores in each level.

REVIEW

- Push . Then, type in your name and push YES. Use  or  to choose the level and push YES. Push the key for the letter that appears on the display.

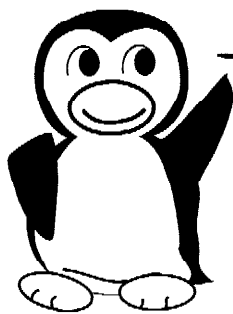



LOOK WHAT THE KEYS CAN DO!





FONT KEY

“Fonts” are the different kinds of letters used in your label. You can change it anytime you want.

To change the font:

1 Hold down  and push . The message “CHOOSE FONT” comes on for a short time. Then, an example of the font that you are now using appears on the display.

2 Push  or  to find the font you want.

3 Push  to change the font. The label appears on the display.

 • The font does not change after you print a label or clear the display. If you want to use a different font in your next label, you will have to change it again.

If you choose this font:

your letters will look like this:



ABCDEFGG

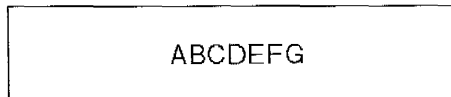

ABCDEF

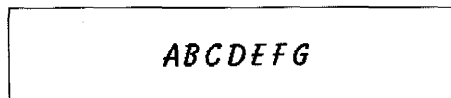

ABCDE



ABCDEFG

ABCDEF



ABCDEFG

ABC



ABCDEFG

A B C



A B C D E F G

A B C



A B C D E F G



- Fonts **A B C** and **A B C** only print in capital letters. If you have small letters in your label, they will change to capital letters when the label is printed out.



☞ To see an example on how to change the font, go to the section "HOW TO USE SYMBOLS & A DIFFERENT FONT" on page 21.









STYLE KEY

"Styles" are the different ways of printing letters in your label. You can change it anytime you want.







To change the style:







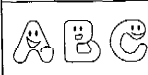

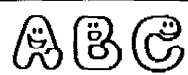
- 1 Hold down  and push . The message "CHOOSE STYLE" comes on for a short time. Then, the name of the style that you are now using appears on the display.

 **2** Push  or  to find the style you want.

 **3** Push  to change the style. The label appears on the display and the style indicator beside **B**~ goes on.

-  • The indicator will not go on when the style is NORMAL.
- The style does not change after you print a label or clear the display. If you want to use a different style in your next label, you will have to change it again.

		and if you choose this style:		
		NORMAL	OUTLINE	BOLD
If you choose this font:	ABCDEFGG	ABC	ABC	ABC
	<i>ABCDEF</i>	<i>ABC</i>	<i>ABC</i>	<i>ABC</i>
	ABCDEF	ABC	ABC	ABC
	ABCDE	ABC	ABC	ABC
	ABC	ABC	ABC	ABC
				
				
		your letters will look like this:		

		and if you choose this style:		
		SHADOW	ITALIC	VERTICAL
If you choose this font:	ABCDEFGFG	ABC	ABC	A B C
	<i>ABCDEF</i>	<i>ABC</i>	<i>ABC</i>	<i>A B C</i>
	ABCDEF	ABC	ABC	A B C
	ABCDE	ABC	ABC	A B C
	ABC	ABC	ABC	A B C
				
				
your letters will look like this:				









To see an example on how to change the style, go to the section "HOW TO USE A DIFFERENT STYLE" on page 24.



FRAME KEY

“Frames” are the pictures and lines around the letters. You can choose from 20 frames and put a frame around the letters anytime you want. But you have to be careful when to choose the frame if you want only part of your label framed. You also have to be sure that you move the cursor so that it is under one of the letters that you want to put in the frame. The flashing underline () that tells you where you are in your label is called the “cursor”.

To put a frame around the label:

-  **1** Hold down  and push . The message “CHOOSE FRAME” comes on for a short time. Then, a frame appears on the display.
-  **2** Push  or  to find the frame you want.
-  **3** Push  to choose the frame. If the frame is put around letters, the message “FRAMED” comes on for a short time. Then, the label appears on the display.

You can choose from these frames:

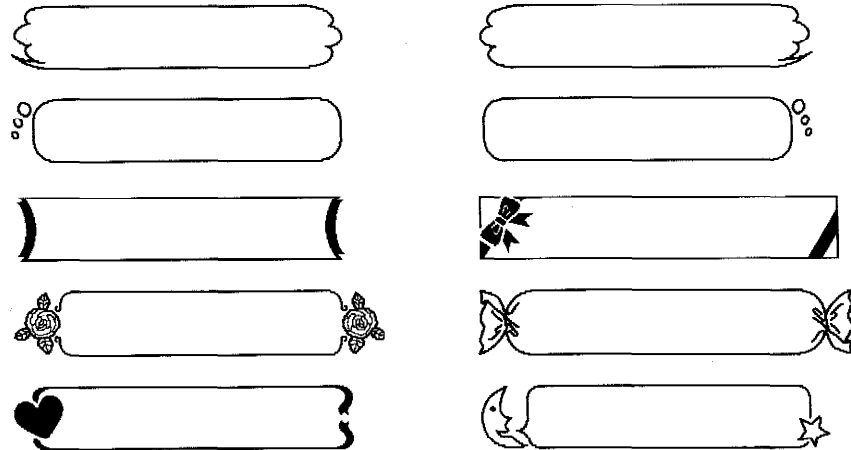
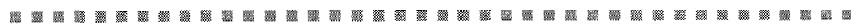

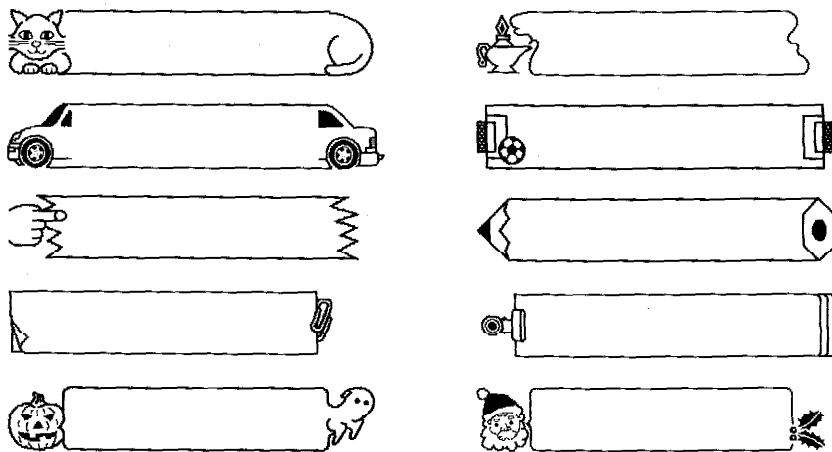

EXAMPLE:

When you want to frame only part of your label, type in that part first. After you frame it, you can move the cursor and type in the rest of your label.

This example is made with the font **ABCDE**, NORMAL style and FULL margins.

1. Type in "I wish I had a steak!"

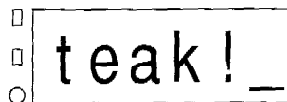

2. Push one time.





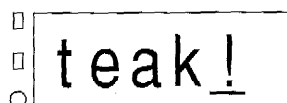

- The cursor has to be under the letters you want to put in the frame. If you don't move the cursor, the frame will be put in after the letters.



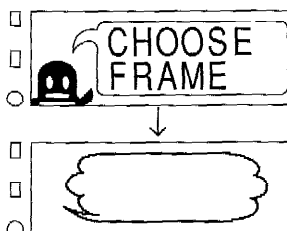

Now, let's put in a frame.

3. Hold down and push .



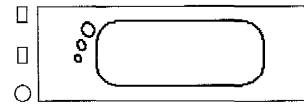

4. Push  or  until  comes on the display.



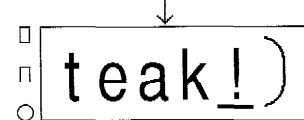

5. Push  to choose the frame.



Now, let's put in a picture outside the frame.

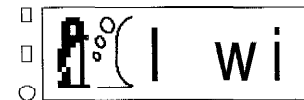

6. Hold down  and push  to move the cursor to the beginning of the label.



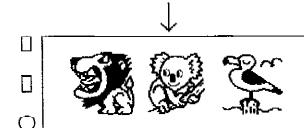

• If you want to move the cursor to the end of the label, hold down  and push .

7. Hold down  and push .

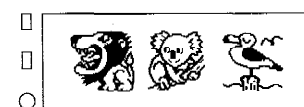

8. Push  or  until the animal picture group flashes.



9. Push .

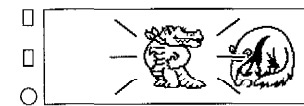

10. Push  or  until the picture of the bulldog flashes.

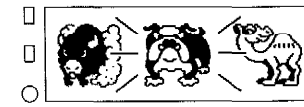

11. Push YES .



If you print the label, it will look like this:

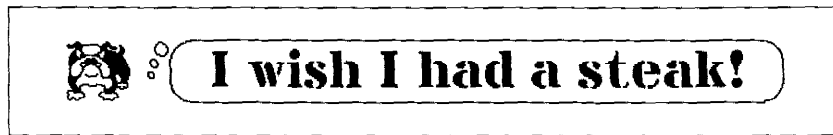



- Another way to put a frame around part of the label is to choose the frame first. Then, type the letters you want in the frame. When that is finished, move the cursor and type in the rest of your label.



MARGIN KEY

“Margins” are the empty spaces on the left and right sides of your label. The size of the margins can be changed at any time.

To change the margins:

-  **1** Hold down CODE and push MARGIN (S 4). The message “ADJUST MARGIN” comes on for a short time. Then, the size of the margin that you are now using appears on the display.
-  **2** Push ← or → to find the margin size you want.
-  **3** Push YES to change the margins. The label appears on the display and the margin indicator beside MARGIN goes on.



- The indicator will not go on when the margin size is FULL.
- The margin size does not change after you print a label or clear the display. But if the Stickerkid is turned off and then turned back on again, the margin size will change back to FULL. If you want to use different margins in your next label, you will have to change it again.

If you choose this margin:

your label will look like this:



FULL

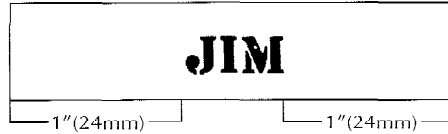

HALF

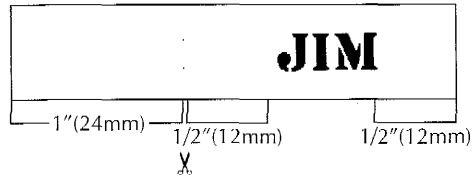

SMALL

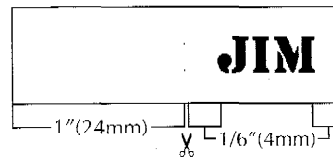

NONE

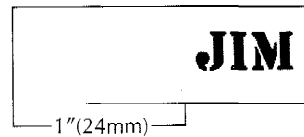



EXAMPLE:

If you choose NONE, you can print many labels in a row to make one label with different fonts and styles. This example is made with CAPS on and the margins on NONE.

Let's print in the first word.

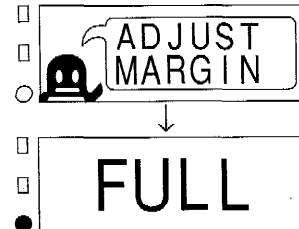
1. Hold down CODE and push MARGIN S a .



2. Push  or  until NONE appears.



3. Push .



4. Change the font to **ABC**.

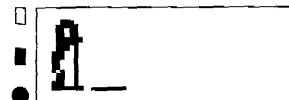

5. Type in "GOOD".



6. Push .



7. Hold down  and push .



8. Push .



Now, let's print in the second word.

9. Change the font to **ABC**.



10. Change the style to **OUTLINE**.





11. Type in "LUCK".



12. Push .



13. Hold down  and push , then push .



Let's print the last word to finish the label.

14. Change the font to .



15. Change the style to NORMAL.





16. Type in "MATT!"



17. Push .



18. Hold down  and push .



- When you use *NONE*, be sure to make more of the label come out before you cut it.

The label will look like this:



 To see an example on how to change the margins, go to the section "HOW TO CHANGE THE MARGINS & PUT IN A FRAME" on page 30.



PICTURE KEY

You can choose from 298 pictures. The pictures are separated into groups. The picture groups are: land animals, sea animals, bugs, dinosaurs, holiday pictures, different things, buildings, transportation, food, pictures for your diary, animals playing sports, plants and others.

To choose a picture:

1 Hold down and push . The message "CHOOSE PICTURE" comes on for a short time. Then, a picture group flashes on the display.

2 Push or to find the picture group you want.

3 Push .

4 Push or to find the picture you want.

5 Push to choose the picture. appears in the label on the display instead of the picture. The picture will look normal when the label is printed.





- Anytime you want to see what a picture looks like again, put the cursor under and push . Push to move down and push to move up, so you can see the rest of the picture. When you are finished looking at the picture, push or again to go back to the label.

You can choose from these pictures:

Animals ()





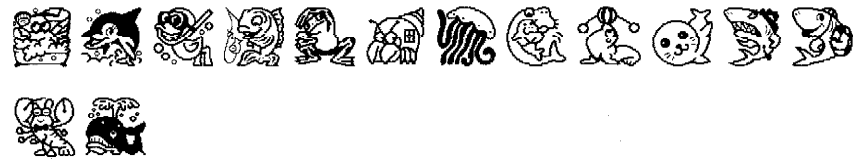

Sea animals (  )



Bugs (  )



Dinosaurs (  )



Holidays (  )





Your things (  )





Buildings (   **)**





Transportation (   **)**



Food (   **)**



Diary pictures (   **)**

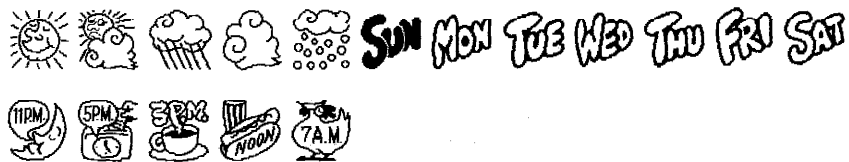

Sports ()



Plants ()



Others ()

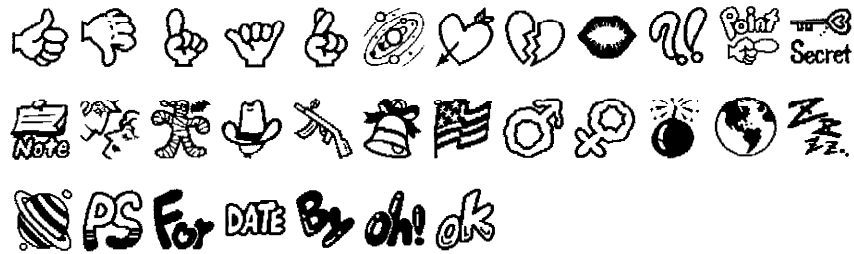

☞ To see an example on how to choose pictures, go to the section “HOW TO MAKE A LABEL WITH PICTURES” on page 17.



MAKE PICTURE KEY

Put a head and a face or a head and a body together to make a picture. There are also two more groups of pictures from which you can choose pictures.

To make a picture:

 **1** Hold down and push . The message "MAKE PICTURE" comes on for a short time. Then, an example of the picture flashes on the display.

 **2** Push or to find the type of picture you want to make.

 **3** Push . The head flashes.

 **4** Push or to find the head you want.

 **5** Push . The face or body flashes.

 **6** Push or to find the face or body you want.

 **7** Push to put the parts together. The message "CHECK?" comes on the display.

 **8** Push .

 **9** Push or to see the rest of the picture.

 **10** Push . **P** appears in the label on the display instead of the picture. The picture will look normal when the label is printed.

 • Anytime you want to see what a picture looks like again, put the cursor under **P** and push . Push to move down and push to move up, so you can see the rest of the picture. When you are finished looking at the picture, push or again to go back to the label.

You can make pictures with these parts:

Childrens' heads

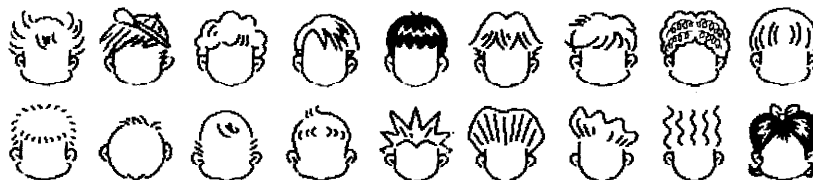



Adults' heads

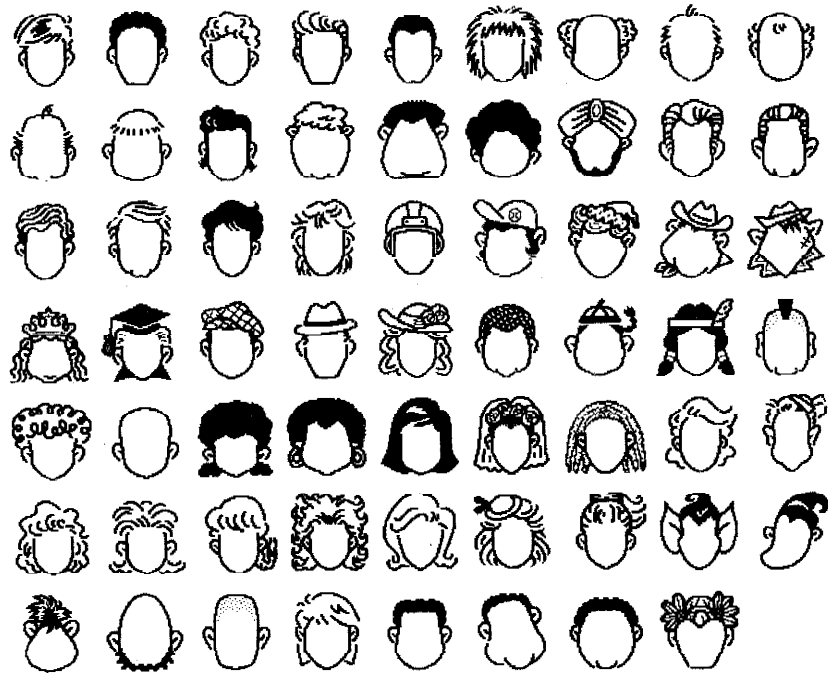

Animals' heads



Strange heads



Faces

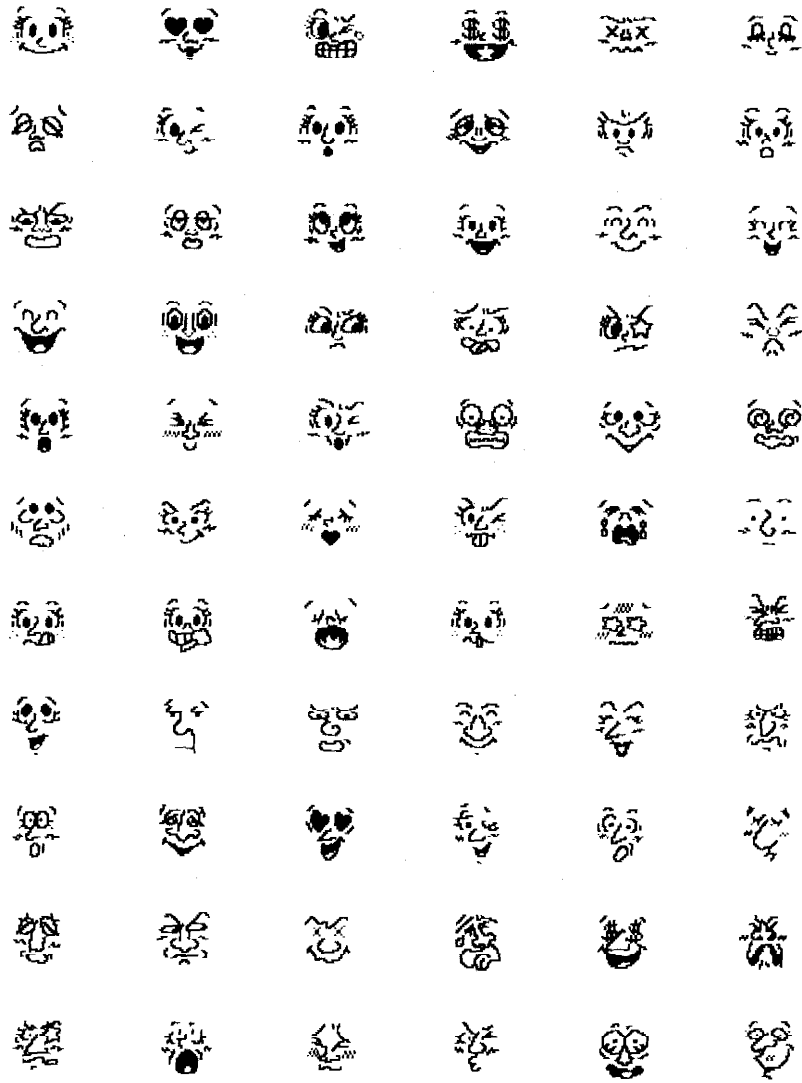

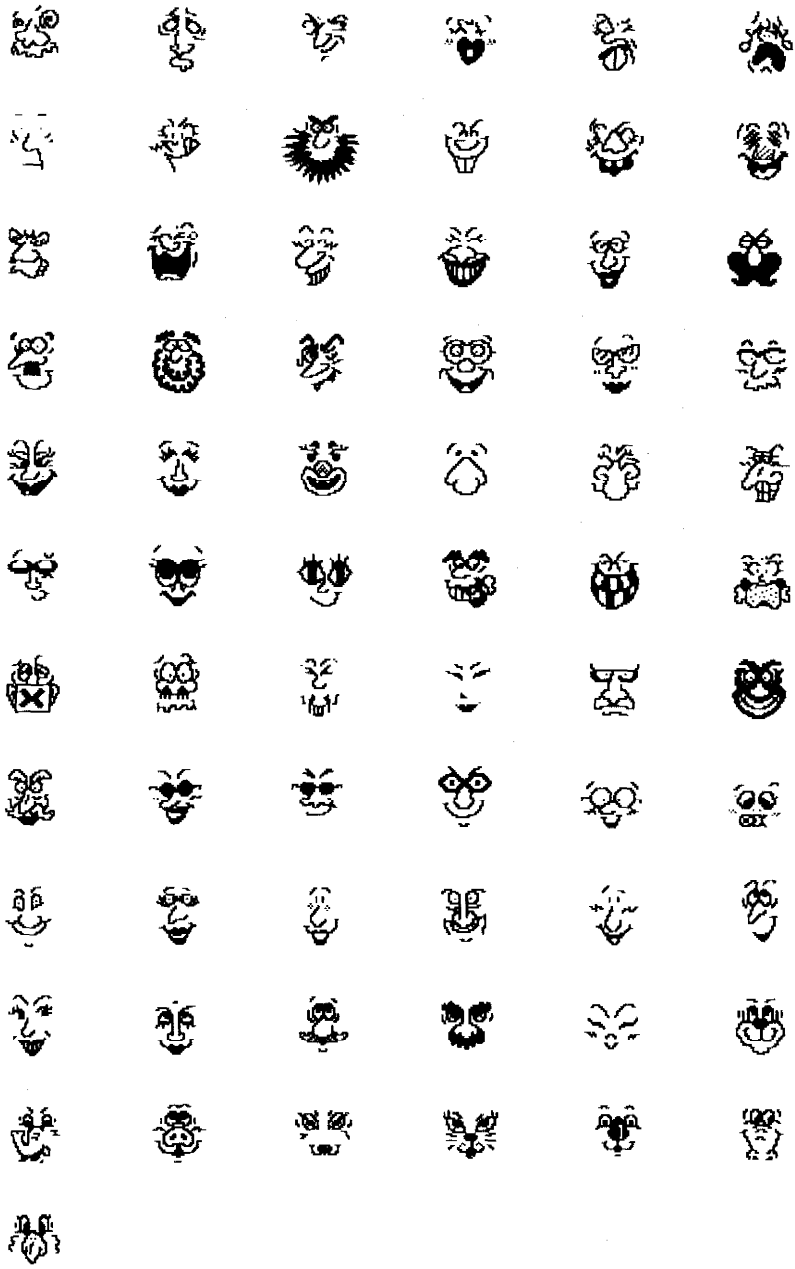

Heads (Side view)



Faces (Side view)

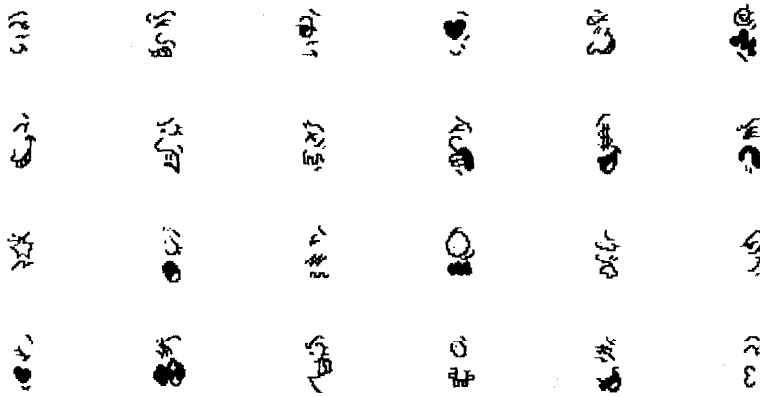

Girls' heads



Womens' heads



Animals' heads



Bodies

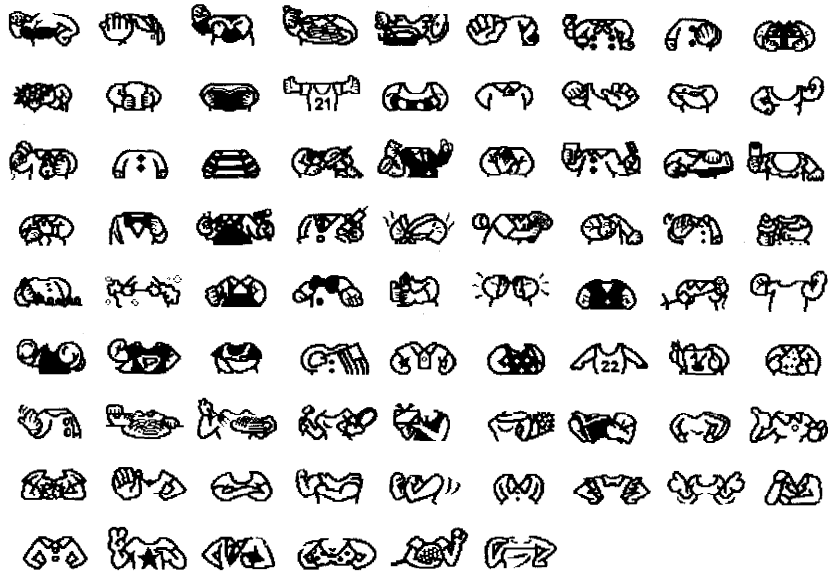

Penguin pictures



Baby pictures



EXAMPLE:

This example is made with FULL margins.

1. Hold down CODE and push .



2. Push or until the animals' heads picture group flashes.



3. Push YES.



4. Push or until the picture of the bear's head flashes.



5. Push YES.



6. Push or until the picture of the bear's face flashes.

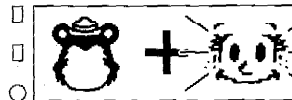

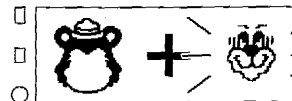

7. Push VCO.

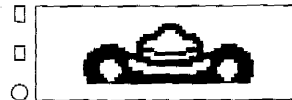

8. Push YES.



9. Push  to see the rest of the bear.

10. Push .















If you print this label, it will look like this:



LANGUAGE MASTER KEY

You can make labels with phrases in eight different languages. The phrases are: "Good morning!", "Good bye.", "Thank you!", "I love you!", "Congratulations!", "How are you?", "Merry Christmas!" and "Happy birthday!". Each phrase can be printed in: French, German, Spanish, Italian, Chinese, Korean and English.

To make a label with a phrase in a different language on it:

-  **1** Hold down  and push . The message "LANGUAGE MASTER" comes on for a short time. Then, the first phrase moves across the display.
-  **2** Push  or  until you find the phrase you want.
-  **3** Push . A country abbreviation and flag appear on the display.
-  **4** Push  or  until you find the language you want.
-  **5** Push . The message "PRINTING" appears on the display and the Stickerkid starts printing the label.



- These labels will always be printed with the font **ABC**, NORMAL style and FULL margins.

If you choose this country and flag: the phrase will be in:

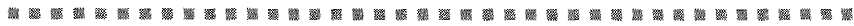

	FRA	→	French
	GER	→	German
	ESP	→	Spanish
	ITA	→	Italian
	CHN	→	Chinese
	KOR	→	Korean
	USA	→	English





☞ To see an example on how to make a label with a phrase in a different language, go to the section “HOW TO CHOOSE A PHRASE” on page 35.



SECRET CODE KEY

You can write secret messages with the Stickerkid’s secret code that only you and your friends can read. With this secret code, you can write notes on labels and pass them to your friends. If anyone else sees your notes, they will never be able to read them.

To write or read a secret message:

-  **1** Type in your message.
-  **2** Hold down  and push . The message “SECRET CODE” comes on for a short time. Then, the message “ENCODE” appears on the display.



3 To make a secret message, push YES .
 To read a secret message, push or until "DECODE" appears on the display. Then, push YES .

4 The letters of "ENCODE" or "DECODE" start flashing. Then, either the encoded or decoded message appears on the display.

EXAMPLE:

To encode a secret message:
 This example is made with the font **ABCDE**, NORMAL style and FULL margins.

1. Type in "No test today!"

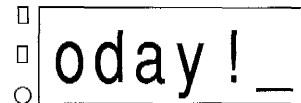

2. Hold down CODE and push .

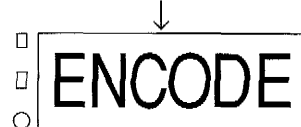

3. Push YES .



If you print the label, it will look like this:

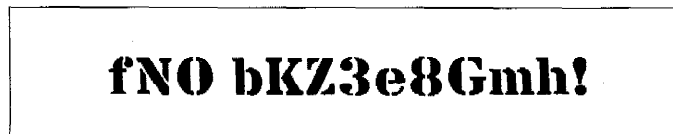

To decode a secret message:

This example is made with the font **ABCDE**, NORMAL style and FULL margins.

1. Type in "fNO bKZ3e8Bmh!"



□ 8Gmh ! _
○

2. Hold down  and push .

□ SECRET
CODE
○



□ ENCODE
○

3. Push  or  until "DECODE" appears on the display.

□ DECODE
○

4. Push .

□ oday ! _
○

If you print the label, it will look like this:

No test today!







MAKE RIBBON KEY

You can choose from eleven different patterns to make beautiful ribbons for decorating cards and presents. One of the patterns is a mystery pattern which chooses a head and different faces and puts them together to make a ribbon. This pattern is different each time you choose it.

To make a ribbon:







1 Hold down  and push . The message “MAKE RIBBON” comes on for a short time. Then, the patterns appear on the display. One of the patterns flashes.

2 Push  or  to find the pattern you want.

3 Push .

4 Push  or  to find the length you want.

 • When you hold down one of these keys, the length will change in steps of 2 inches.

 • Push  to see the length in centimeters. Push  again to change the length back to inches.

5 Push . The message “PRINTING” comes on and the Stickerkid starts printing the label.

 • Your ribbon can be between 2 inches (5 cm) and 20 inches (50 cm).

 • These labels will always be printed with the NORMAL style and FULL margins.

If you choose this pattern:

your ribbon will look like this:

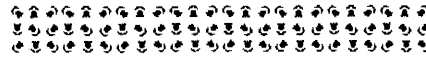

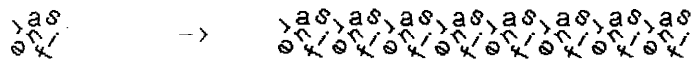
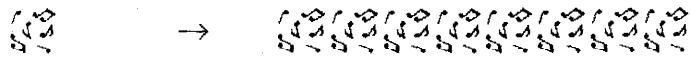



- *The Stickerkid chooses a head and puts it together with different faces to make the mystery ribbon. So, each time you choose this pattern, the ribbon will be different.*



☞ To see an example on how to print a ribbon, go to the section "HOW TO MAKE A RIBBON" on page 38.



MUSIC KEY

Use this key to turn on or off the music that the Stickerkid plays every time you push a key.

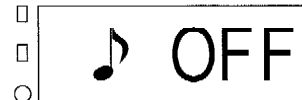

To turn off the music:

Hold down and push . The message "  OFF" comes on for a short time. Then, the label appears on the display again.



- *Even if the Stickerkid is turned off, then on again, the music will stay off until you turn it back on.*

To turn on the music:

Hold down and push . The message "  ON" comes on for a short time. Then, the label appears on the display again.

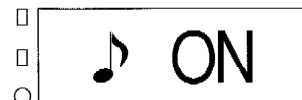



ERASE/CLEAR ALL KEY



Use this key to erase a letter or picture from the label.
You can also use this key to get rid of your whole label. This is called “clearing the display”.

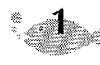

To erase a letter:

 **1** Move the cursor so that it is to the right of the letter that you want to erase.

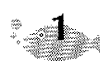
 **2** Push .

To clear:

 **1** Hold down  and push . The message “CLEAR?” comes on.

 **2** Push . The display is empty and the only thing left is the penguin and the cursor.



 • When you clear the display, the font, style and margins do not change. If you want to use a different font, style or margin in your next label, you will have to change them again.





FRENCH ACCENTED LETTER KEY

Use this key to type in one of the French accented letters. “Accents” are the dots or lines on the top or bottom of a letter.
The French accented letters are: Ä, ä, Â, â, À, à, Ç, ç, È, è, Ê, ê, Ë, è, É, é, Ì, ï, Î, î, Ö, ö, Ô, ô, Ü, ü, Û, û, Ù, ù AE, æ, Œ, œ.

To choose a French accented letter:

 **1** Hold down  and push . The message “CHOOSE FRENCH” comes on for a short time. Then, the cursor appears below one of the accented letters.

2 Push  or  until the cursor is under the letter you want.

3 Push . The letter appears in the label.

EXAMPLE:

If you want to make a label for your French pen pal, Benoît:
This example is made with the font **ABCDE**, NORMAL style and FULL margins.

1. Type in "Beno".



2. Hold down  and push .

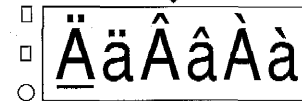

3. Push  or  until the cursor is under "î".

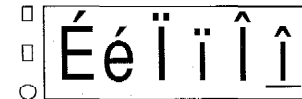

4. Push .

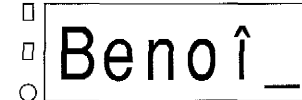

5. Type in "t".

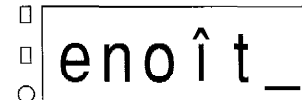

If you print this label, it will look like this:





SPANISH ACCENTED LETTER KEY

Use this key to type in one of the Spanish accented letters
“Accents” are the dots or lines on the top or bottom of a letter
The Spanish accented letters are: Ç, ç, Ü, ü, Ñ, ñ, á, é, í, ó, ú
¿, ¡.

To choose a Spanish accented letter:

- 1 Hold down and push . The message “CHOOSE SPANISH” comes on for a short time. Then, the cursor appears below one of the accented letters.
- 2 Push or until the cursor is under the letter you want.
- 3 Push . The letter appears in the label.

EXAMPLE:

If you want to make a label for your Spanish pen pal, María:
This example is made with the font **ABCDE**, NORMAL style
and FULL margins.

1. Type in “Mar”.

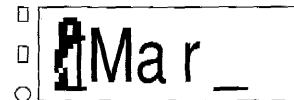

2. Hold down and push .

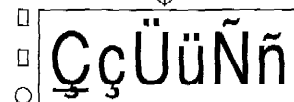

3. Push or until the cursor is under “í”.

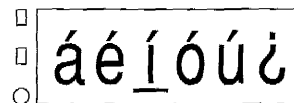

4. Push YES.



5. Type in "a".



If you print this label, it will look like this:



SYMBOL

SYMBOL KEY

Use this key to choose a symbol and add it to your label. The symbols are: •, +, ×, ÷, =, /, [,], ↑, ↓, →, ←, ☞, ☜, ♪, ♥, ★, ☎.

You can also use this key to type in the pink punctuation marks (-, ,, :, ?, ', ") that are on some of the keys.

☞ To find out how to type in the punctuation marks, go to the next section "PUNCTUATION MARK KEYS".

To choose a symbol:

 **1** Hold down CODE and push SYMBOL. The message "CHOOSE SYMBOL" comes on for a short time. Then, the cursor appears below one of the symbols.

 **2** Push ☞ or ☜ until the cursor is under the symbol you want.

 **3** Push YES. The symbol appears in the label.

☞ To see an example on how to choose a symbol, go to the section "HOW TO USE SYMBOLS & A DIFFERENT FONT" on page 21.



3RD COLOR



PUNCTUATION MARK KEYS

These keys can be used to type in the pink punctuation marks (-, ;, :, ?, ', ") that are on them.

To type in a punctuation mark:



Hold down  and push the key for the punctuation mark you want.

EXAMPLE:

This example is made with the font **ABCDE**, NORMAL style and FULL margins.

1. Type in "Marc".

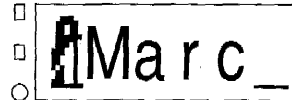

2. Hold down  and push .



3. Type in "s".

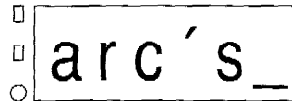

If you print the label, it will look like this:





SHIFT/CAPS KEY

Use this key to type in capital letters or the symbols on top of the number keys.

To type in a capital letter or a symbol:

 **Hold the**  **key and push the key for the letter or symbol you want.**

To type only in capital letters:

 **1 Hold down**  **and push**  **. The CAPS indicator goes on.**

 **2 Type in your message.**

-  To see an example on how to type in a capital letter, go to the section “HOW TO MAKE A LABEL” on page 10.
To see an example on how to type in only capital letters, go to the section “HOW TO CHANGE A LABEL” on page 14.

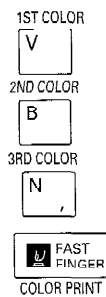

MULTI-COLOR PRINTING KEYS

You can use these keys to print lots of colorful labels with two or three ink colors.

-  To see an example on how to make a label with three ink colors, go to the section “HOW TO PRINT WITH TWO OR THREE COLORS” on page 52.



LEFT KEY

Use this key to move the cursor to the left or to see more of the picture. The flashing underline () that tells you where you are in your label is called the “cursor”.

To move the cursor to the left or move a picture up:

 **Push** .

To move the cursor to the beginning of the label:

 **Hold down**  **and push** .



RIGHT KEY

Use this key to move the cursor to the right or to see more of the picture.

To move the cursor to the right or move a picture down:

Push .

To move the cursor to the end of the label:

Hold down **and push** .



PRINT/GIANT PRINT KEY

Use this key to print your label or to make your letters two to four times bigger than normal size and print them on two, three or four labels.

To print a label:

1 Type in your label.

2 Push .

To make a giant label:

1 Hold down and push . The message “GIANT PRINT” comes on for a short time. Then, you can choose how big you want the label to be.

2 Push or to find the size you want.

3 Push . The message “PRINTING” appears and the Stickerkid prints the label.



- The margins of these labels will always be 1/2” (12 mm).



EXAMPLE:



This example is made with the font **ABCDE**, NORMAL style and FULL margins.

1. Type in "HI!"

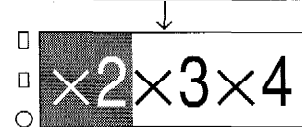

2. I hold down **CODE** and push **PRINT**.



3. Push  or  until "X3" is chosen.



If you print the label, it will look like this:

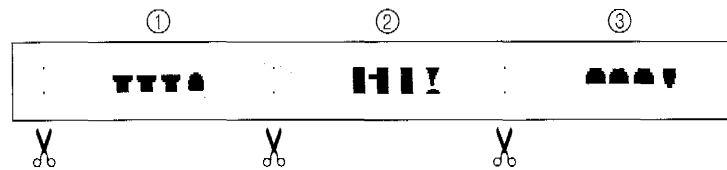

Cut the three labels and put them together like this:

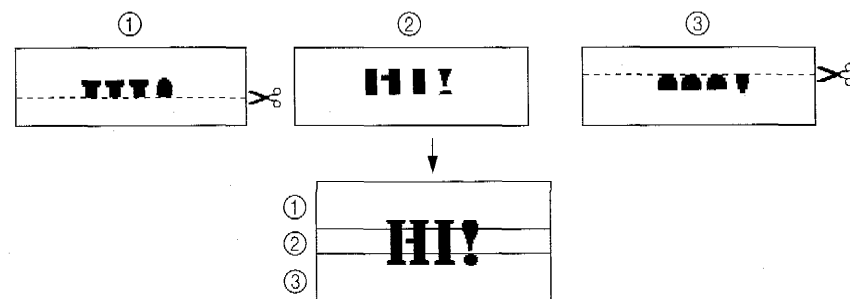

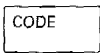

CODE KEY

Hold down this key and push another key that has pictures or words written in green on or above it. Now, you can use those special jobs. These jobs are called "functions".



SPACE/FEED KEY

Use this key to type in a space or to make more of the label come out. Making more of the label come out of the exit slot is called "feeding" the label.

To put in a space:



To feed out 1" (24 mm) of the tape:

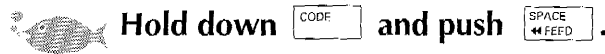

FAST FINGER GAME KEY

Use this key to start the Fast Finger game. Test your speed. How fast can you push the keys for the letters that appear on the display?



To see an example on how to play the typing game, go to the section "HOW TO PLAY THE FAST FINGER GAME" on page 59.



YES KEY

Push this key to answer “yes”.



NO KEY

Push this key to answer “no”.



ON/OFF KEY

Use this key to turn the Stickerkid on and off.

To turn it on:



Push . You can start making your labels after the “Hello!” message appears.



- The Stickerkid will turn off within 5 minutes if a key is not pushed.

To turn it off:



Push . It will turn off after the “GOOD BYE.” message appears.



- When the Stickerkid is off, the label and the settings are not erased.

RESETTING THE MACHINE



You can change the font, style, margins and all the other settings back to the ones that were used when you first bought your Stickerkid. If you reset the machine, everything will be erased, even your name.

To reset the machine:



1 Turn off the Stickerkid.



 **2** Hold down and push and  at the same time. The message "RESET?" appears on the display.

 **3** Push . You can start making labels after the "Hello!" message appears.



• If you decide that you don't want to erase everything, push .



• Your name will also be erased.

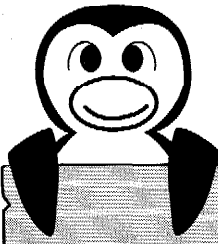

HOW TO CHANGE THE CUTTER

If the cutter does not cut well, take it out and put in a new one. Since the cutter is very sharp, ask an adult to help you.

⚠ CAUTION

- *Don't touch the cutter blade.*
- *The cutter is very dangerous. Don't put it in your mouth and don't let smaller children put it in their mouth. Right after you change it, throw it away.*



- The average life of the cutter should be about 2000 cuts.



1 Turn off the Stickerkid.



2 Open the cassette cover and take out the tape cassette.

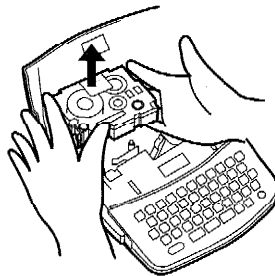

- 3** Grab the big plastic part of the cutter with your fingers and pull out the cutter.

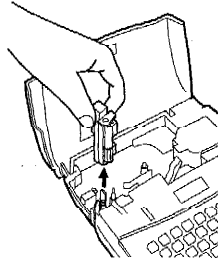

- 4** Grab the big plastic part of the new cutter and put it over the metal bar and pole.

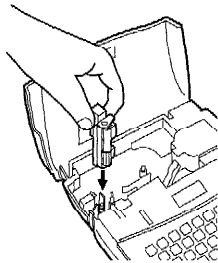

- 5** Put in the tape cassette and close the cassette cover.



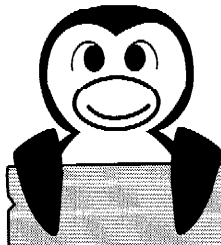

CLEANING THE PRINT HEAD AND ROLLERS

Sometimes, the Stickerkid cannot print well because dust and dirt are on the print head and rollers. If you use the Stickerkid outside, this may happen often. If the print head has dust on it, the label will have a blank line in it. So clean the print and rollers once in a while. If you don't understand something, ask someone to help you.

- 1 Turn off the Stickerkid.
- 2 Open the cassette cover and take out the cassette.

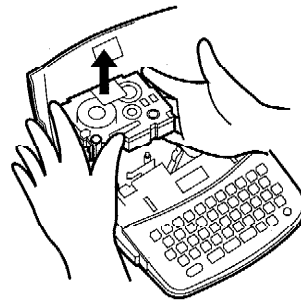
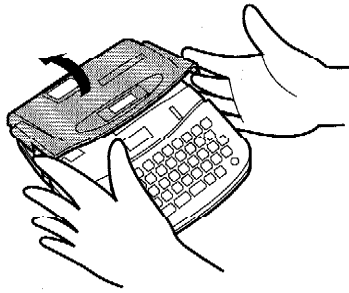

- 3** **Cleaning the print head: Use a dry cotton swab to gently rub up and down on the print head.**

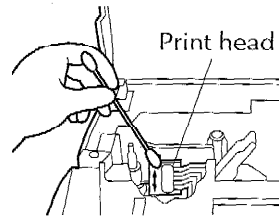

- Cleaning the rollers: Rotate each roller while using a dry cotton swab to wipe up and down on them.**

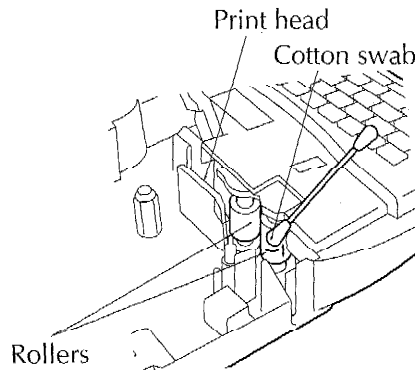

- 4** **Put in the cassette and try printing again.**



If there is still dust on the print head and rollers, ask an adult to help you clean them.

- 5** **Take out the cassette and go back to step 3. This time use a cotton swab dipped in isopropyl (rubbing) alcohol.**

- 6** **Put in the cassette and try printing again.**

If there is still a blank line in the label, take your Stickerkid to your service representative.

TROUBLESHOOTING

PROBLEM	REMEDY
1. Nothing comes on the display.	<ul style="list-style-type: none"> • If there are no batteries, put them in. (☞ Go to page 5.) • If  comes on the display, the batteries are low. So change the batteries. (☞ Go to page 5.)
2. The Stickerkid does not print.	<ul style="list-style-type: none"> • If  comes on the display, the batteries are low. So change the batteries. (☞ Go to page 5.) • If the tape cassette is empty, put in a new one. (☞ Go to page 6.) • If the tape cassette is not put in correctly, fix it. (☞ Go to page 6.) • If the print head is dirty, clean it. (☞ Go to page 105.)
3. The label has stripes on it.	<ul style="list-style-type: none"> • If the tape cassette is empty, put in a new one. (☞ Go to page 6.)
4. The label does not stick.	<ul style="list-style-type: none"> • If the paper or plastic on the back of the label is not taken off, take it off. (☞ Go to page 12.) • If the thing that you are sticking the label on is dirty or greasy, clean it.

SPECIFICATIONS

HARDWARE

Input device:	Keyboard - 49 keys
LCD:	16 × 48 dots 3 indicators
Print tape:	Pressure-sensitive, adhesive-based (TZ tapes only) 26' 3" (8 m) long 3/4" (18 mm Wide)
Power supply:	6 AA alkaline batteries Auto power off after 5 minutes
Print head:	64 dot / 180 dpi
Dimensions:	7" × 8" × 2" (174 × 200 × 50 mm)
Weight:	1.8 lbs (including batteries)

SOFTWARE

Character size:	4 sizes
Character fonts:	7 built-in typefaces
Buffer size:	99 characters
Number of characters:	141 characters
Print styles:	Normal, Outline, Bold, Shadow, Vertical and Italic

INDEX

A

All capital letters 14, 96

B

Batteries 5, 107

Battery cover 5

Bodies 42, 83

Bold style 65

C

CAPS key 14, 96

CAPS indicator 2, 14, 97

Cassette window 1

Cassettes 6

Changing a label 15

Changing the font 22, 63

Changing the margins 31, 70

Changing the style 27, 64

Choosing a frame 33, 67

Choosing a language 36, 85

Choosing a pattern 38, 88

Choosing a phrase 36, 85

Choosing a picture 17, 74

Choosing a ribbon length 39, 88

Choosing a symbol 21, 95

Cleaning the print

 head/rollers 105

Clear all key 13, 92

Code key 100

Cursor 2, 15

Cutter lever 1, 11

D

Decode 46, 87

Display 1, 2

E

Empty spaces 30, 70

Encode 45, 87

Erase key 7, 15, 92

Exit slot 1

F

Faces 80, 82

Fast finger game key 59, 100

Feed key 73, 100

Flashing line 2, 15

Font key 22, 63

Frame key 33, 67

French accented letter key 92

Full margins 70

Functions 100

G

Getting rid of labels 13, 92

Giant print key 48, 98

H

Half margins 71

Heads 42, 78, 82

I
Ink cassette 55
Italic style 30, 66

J
Jobs 100

K
Keyboard 3
Kinds of letters 21, 63

L
Language master key 35, 85
Left key 97
Letter keys 4

M
Make picture key 42, 77
Make ribbon key 38, 88
Making a picture 42, 77
Making a secret
 message 44, 86
Making labels 10
Margin key 31, 70
Margin indicator 31, 70
Moving the cursor 15, 97, 98
Multi-color
 printing keys 52, 97
Music key 91

N
Name 7
No key 101
No margins 71

None 71
Normal style 49, 65
Not printing 107
Number keys 4

O
On/Off key 7, 101
Outline style 65

P
Penguin 2, 8
Phrase 36
Picture key 17, 74
Pictures and lines
 around letters 30, 67
Print head 105
Print key 11, 98
Punctuation mark keys 96

R
Resetting 101
Right key 98
Rollers 105

S
Secret code key 45, 86
Shadow style 66
Shift key 7, 10
Small margins 31, 71
Space key 19, 100
Spanish accented letter key .. 94
Sticking on labels 12, 107
Stripes 107
Style key 27, 64
Style indicator 27, 65
Symbol key 21, 95



T

Tape cassette 6, 55
Turning on/off 7, 101
Turning on/off CAPS 14, 97
Typing in letters 8, 10

V

Vertical 27, 66

W

Ways of printing 24, 64

Y

Yes key 101



SUPPLIES

You can obtain tape and ink cassettes from your nearest authorized Brother dealer. Use only Brother TZ tapes with this machine. Do not use tapes that do not have the **TZ** mark. Brother cannot be held responsible for trouble caused by the use of unauthorized supplies.

Non-laminated TZ Tape Cassettes

Stock No.	Description	Q'ty	Price
Pastel-colored Tape Cassettes			
TZ-N541	Black letters on blue tape, 3/4" (18 mm)	1	\$18.95
TZ-N641	Black letters on yellow tape, 3/4" (18 mm)	1	\$18.95
TZ-N741	Black letters on green tape, 3/4" (18 mm)	1	\$18.95
TZ-NE41	Black letters on pink tape, 3/4" (18 mm)	1	\$18.95
TZ-NF41	Black letters on purple tape, 3/4" (18 mm)	1	\$18.95
TZ-N841	Black letters on gold tape, 3/4" (18 mm)	1	\$18.95
Patterned Tape Cassettes			
TZ-PC41	Christmas, 3/4" (18 mm)	1	\$18.95
TZ-PH41	Heart, 3/4" (18 mm)	1	\$18.95
TZ-PF41	Fruit, 3/4" (18 mm)	1	\$18.95
TZ-PM41	Marine, 3/4" (18 mm)	1	\$18.95
Separate Cassettes for Multi-Color Printing			
TZ-T240	Base Tape Cassette - White, 3/4" (18 mm)	1	\$19.95
TZ-R041	Ink Ribbon Cassette - Black	1	\$12.95
TZ-R042	Ink Ribbon Cassette - Red	1	\$12.95
TZ-R043	Ink Ribbon Cassette - Blue	1	\$12.95
Other			
TC-6	Tape Cutter	1	\$7.95



SUPPLIES ORDER FORM

Dear Customer:

Please send this order form, along with proper payment, to the address below. OR, Visa, MasterCard or Discover holders, call toll free, anytime, 1-800-284-4357, or fax your completed order form to 1-800-947-1445.

Stock No.	Description	Price	Quantity	Total
Subtotal				

Name: _____ **Accessory Subtotal:** \$ _____

Address: _____ AZ, CA, CT, FL, GA, IL, LA, MA, MI, MN,
 City: _____ MO, NC, NJ, NV, NY, TN, TX, VA, WA
 State/Zip: _____ residents add applicable sales tax \$ _____

Daytime Phone: _____ **Shipping/Handling Options**

SEND ORDER FORM TO:
 Brother International Corp.
 Attn: Consumer Accessory Div.
 P.O.Box 341332
 Bartlett, TN38184-1332

Please choose one:

- Standard (\$5.00)
- 2nd day air freight (\$8.75)
 Mandatory for all deliveries
 outside of the continental U.S.
 (Alaska, Hawaii, Puerto Rico,
 Virgin Islands & Canada)
- All other overseas orders (\$25.00) \$ _____

TOTAL DUE \$ _____

Method of payment (Check one)
 Visa MasterCard Discover Check/Money Order
 Account Number _____
 Expiration Date _____
 Signature _____

*Prices subject to change without notice.



• GUIA DE INSTRUCCIONES •

PROCURA TENER CUIDADO PARA NO HACERTE DAÑO
Y PARA NO ESTROPEAR EL STICKERKID

- No toques el cortador con los dedos. Esta muy afilado y podrías cortarte.

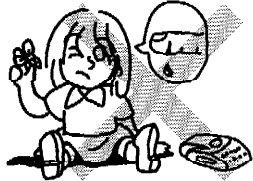

- No te enganches las etiquetas en el cuerpo.



- No te pongas las etiquetas en la boca.

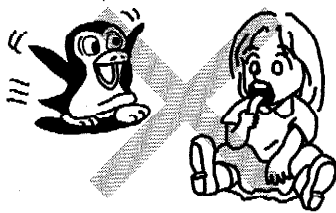

- No saques tú mismo el cortador amarillo. Pídeselo que lo haga a una persona mayor.



- No desmontes los casetes del Stickerkid.



- No lo utilices en lugares con mucho polvo o con humedad.

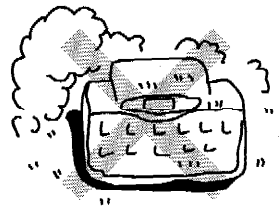

- No lo tires al suelo.

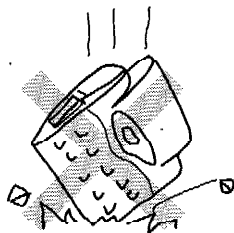

- No pongas nada pesado encima.

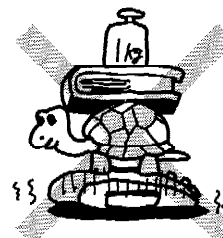

- Procura que no se caiga comida ni bebida encima. El Stickerkid no es impermeable.

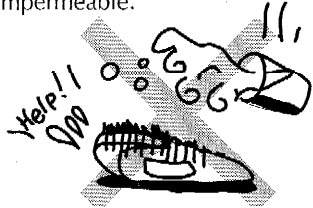

- No toques el cabezal de impresión con los dedos. Se puede romper con facilidad.

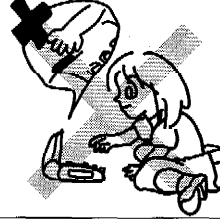

- No hagas presión en el visualizador de LCD.



- No toques la palanca del cortador mientras la máquina está imprimiendo o haciendo avanzar la etiqueta. Espera a que se pare el avance de la etiqueta.

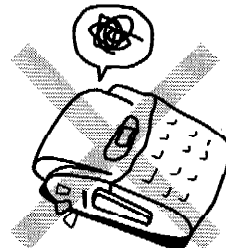

- No imprimas etiquetas si el casete está vacío o si no hay casete en el Stickerkid.

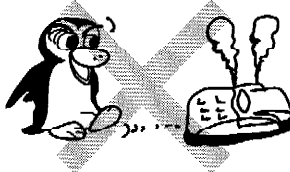

- No tires con fuerza de la palanca del cortador.



- No dejes el Stickerkid en lugares muy calientes durante mucho tiempo, como por ejemplo dentro de un automóvil, cerca de una estufa o bajo la luz directa del sol.



- No tires de las etiquetas cuando están saliendo de la máquina.

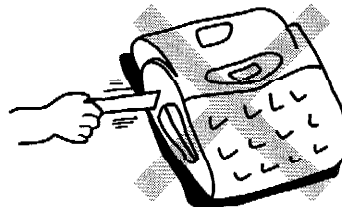

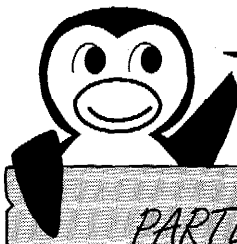

¡PREPARATE!

PARTES IMPORTANTES DEL STICKERKID

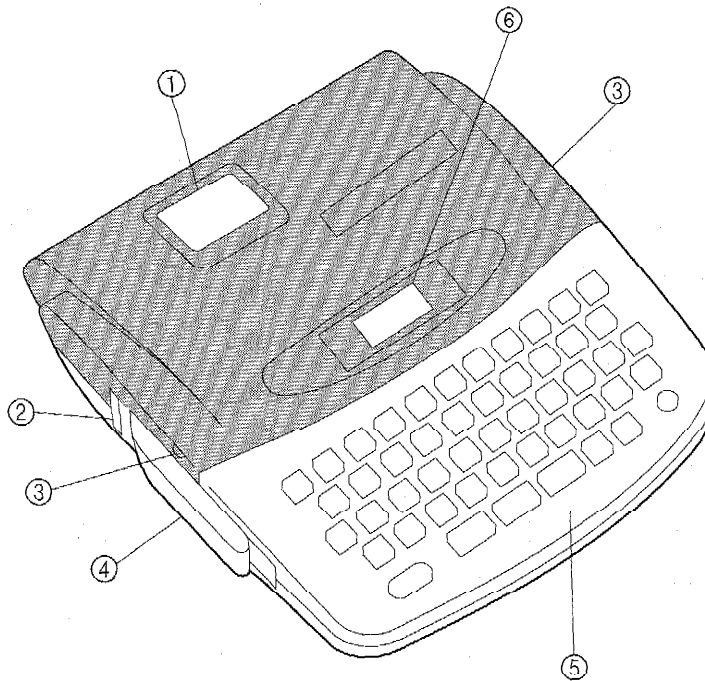

- ① **Ventanilla del casete**.. Mira por aquí para ver la cinta que queda y el tipo de cinta que es.
- ② **Ranura de salida ...** Por aquí es por donde sale la etiqueta.
- ③ **Lengüetas de la cubierta del casete...** Se usan para levantar la cubierta del casete cuando hay que cambiar el casete.
- ④ **Palanca del cortador....** Se usa para cortar las etiquetas.
- ⑤ **Teclado** Las teclas sirven para escribir las etiquetas y para hacer muchas otras cosas
- ⑥ **Visualizador** Míralo para ver lo que estás escribiendo.

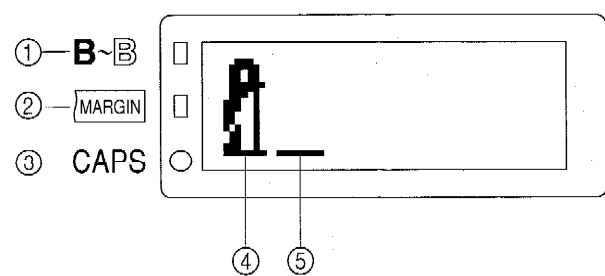

- ① **Indicador del tipo** . Este título aparece cuando cambia la forma de las letras que se imprimen en la etiqueta. (Las formas distintas de las letras de impresión se llaman "tipos".)
- ② **Indicador de margen ...** Este pequeño recuadro aparece cuando cambias el tamaño del espacio vacío de ambos lados de la etiqueta. (Los espacios vacíos de ambos lados de la etiqueta se llaman "márgenes".)
- ③ **Indicador de mayúsculas...** Este pequeño círculo aparece cuando escriben todas las letras en mayúsculas.
- ④ **Pingüino** Verás un pingüino al principio de la letra.
- ⑤ **Cursor** Esa pequeña línea que parpadea en la letra te indica la posición en la que estás ahora.

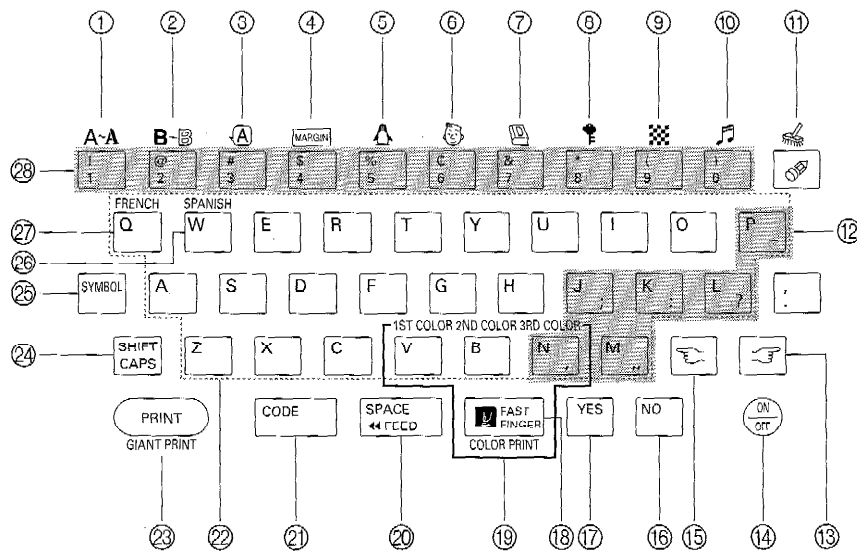

① **Tecla de juego de caracteres** Es para cambiar la clase de letras que usas en la etiqueta.

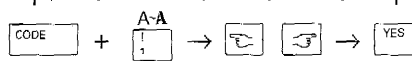

☞ Consulta la página 21, 63.

② **Teca de tipos** Sirve para cambiar la forma en la que se imprimen las letras en la etiqueta.

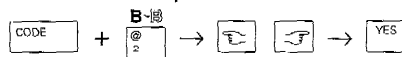

☞ Consulta la página 24, 64.



- ③ **Tecla de recuadro** Sirve para poner un recuadro en torno a lo que escribes en la etiqueta.

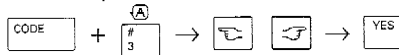

☞ Consulta la página 30, 67.

- ④ **Tecla del margen ..** Sirve para hacer espacios vacíos más grandes o más pequeños a los lados.

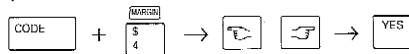

☞ Consulta la página 30, 70.

- ⑤ **Tecla de imágenes...** Sirve para poner imágenes en la etiqueta.

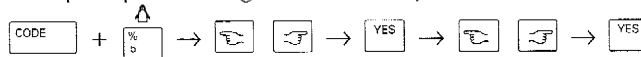

☞ Consulta la página 17, 74.

- ⑥ **Tecla de hacer imágenes**

Sirve para hacer imágenes juntando una cara y una cabeza o una cabeza y un cuerpo.

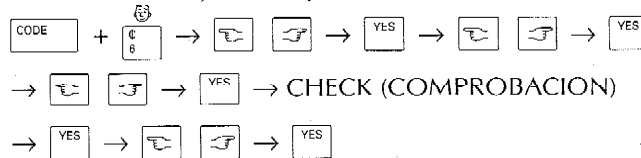

☞ Consulta la página 40, 77.

- ⑦ **Tecla principal del idioma**

Sirve para seleccionar una frase en otro idioma.

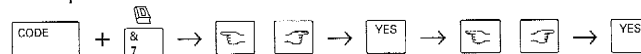

- ⑧ **Tecla de código secreto**

Sirve para leer o escribir una etiqueta con un código secreto.

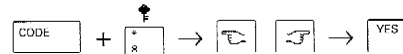

- ⑨ **Tecla de lazos** Sirve para hacer una etiqueta con un patrón o para decorarla.

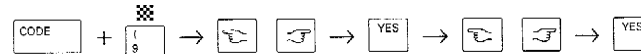

☞ Consulta la página 38, 88

- ⑩ **Tecla de música** Sirve para encender y apagar la música.

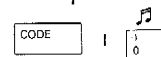

- ⑪ **Tecla de borrar/eliminar** Sirve para borrar una letra o imagen del texto o para eliminar la etiqueta.

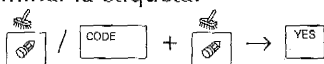

- ⑫ **Teclas de marcas de puntuación** Sirven para escribir las marcas rosas que están en algunas teclas.

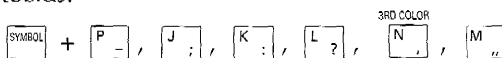

- ⑬ **Tecla de la derecha ...** Sirve para mover el cursor hacia la derecha o para bajar una imagen.

- ⑭ **Tecla de encendido apagado** Sirve para encender y apagar el Stickerkid.

- ⑮ **Tecla de la izquierda ...** Sirve para mover el cursor hacia la izquierda o para subir una imagen.

- ⑯ **Teclas de No** Sirve para contestar "No" a las preguntas que algunas veces te hace el Stickerkid.

- ⑰ **Teclas de Sí** Sirve para contestar "Sí" a las preguntas que algunas veces te hace el Stickerkid.

- ⑱ **Tecla del juego de dedos rápidos ..** Sirve para jugar al juego de escribir del Stickerkid.

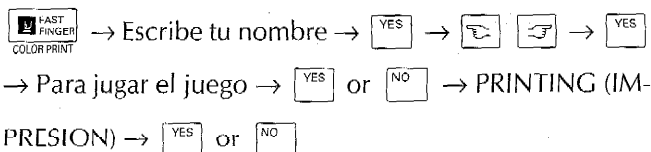

- ⑲ **Teclas de impresión en varios colores ..** Sirven para imprimir una etiqueta con dos o tres colores de tinta.



brother®

UN0683001
Printed in Japan